



### Features

- High Blocking Voltage with Low On-Resistance
- High Speed Switching with Low Capacitances
- Easy to Parallel and Simple to Drive
- Avalanche Ruggedness
- Resistant to Latch-Up
- Halogen Free, RoHS Compliant

### Benefits

- Higher System Efficiency
- Reduced Cooling Requirements
- Increased Power Density
- Increased System Switching Frequency

### Applications

- Solar Inverters
- Switch Mode Power Supplies
- High Voltage DC/DC Converters
- LED Lighting Power Supplies

$V_{DS}$	1200 V
$I_D @ 25^\circ\text{C}$	18 A
$R_{DS(on)}$	160 m $\Omega$

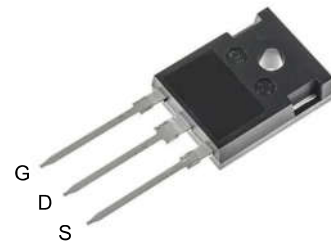

TO-247-3  
Package

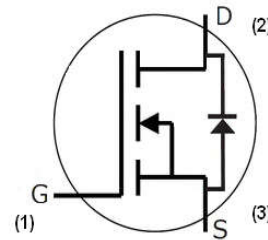

Part Number	Package
C2M0160120D	TO-247-3

### Maximum Ratings ( $T_C = 25^\circ\text{C}$ unless otherwise specified)

Symbol	Parameter	Value	Unit	Test Conditions	Note
$V_{DSmax}$	Drain - Source Voltage	1200	V	$V_{GS} = 0\text{ V}, I_D = 100\ \mu\text{A}$	
$V_{GSmax}$	Gate - Source Voltage	-10/+25	V	Absolute maximum values	
$V_{GSop}$	Gate - Source Voltage	-5/+20	V	Recommended operational values	
$I_D$	Continuous Drain Current	18	A	$V_{GS} = 20\text{ V}, T_C = 25^\circ\text{C}$	Fig. 19
		12		$V_{GS} = 20\text{ V}, T_C = 100^\circ\text{C}$	
$I_{D(pulse)}$	Pulsed Drain Current	40	A	Pulse width $t_p$ limited by $T_{jmax}$	Fig. 22
$P_D$	Power Dissipation	125	W	$T_C = 25^\circ\text{C}, T_J = 150^\circ\text{C}$	Fig. 20
$T_J, T_{stg}$	Operating Junction and Storage Temperature	-55 to +150	$^\circ\text{C}$		
$T_L$	Solder Temperature	260	$^\circ\text{C}$	1.6mm (0.063") from case for 10s	
$M_d$	Mounting Torque	1	Nm lbf-in	M3 or 6-32 screw	
		8.8			

### Electrical Characteristics (T<sub>c</sub> = 25°C unless otherwise specified)

Symbol	Parameter	Min.	Typ.	Max.	Unit	Test Conditions	Note
V <sub>(BR)DSS</sub>	Drain-Source Breakdown Voltage	1200			V	V <sub>GS</sub> = 0 V, I <sub>D</sub> = 100 μA	
V <sub>GS(th)</sub>	Gate Threshold Voltage	2.0	2.9	4	V	V <sub>DS</sub> = V <sub>GS</sub> , I <sub>DS</sub> = 2.5 mA	Fig. 11
			2.4		V	V <sub>DS</sub> = V <sub>GS</sub> , I <sub>DS</sub> = 2.5 mA, T <sub>J</sub> = 150°C	
I <sub>DSS</sub>	Zero Gate Voltage Drain Current		1	100	μA	V <sub>DS</sub> = 1200 V, V <sub>GS</sub> = 0 V	
I <sub>GSS</sub>	Gate-Source Leakage Current			250	nA	V <sub>GS</sub> = 20 V, V <sub>DS</sub> = 0 V	
R <sub>DS(on)</sub>	Drain-Source On-State Resistance		160	196	mΩ	V <sub>GS</sub> = 20 V, I <sub>D</sub> = 10 A	Fig. 4, 5, 6
			290			V <sub>GS</sub> = 20 V, I <sub>D</sub> = 10A, T <sub>J</sub> = 150°C	
g <sub>fs</sub>	Transconductance		3.8		S	V <sub>DS</sub> = 20 V, I <sub>DS</sub> = 10 A	Fig. 7
			5.3			V <sub>DS</sub> = 20 V, I <sub>DS</sub> = 10 A, T <sub>J</sub> = 150°C	
C <sub>iss</sub>	Input Capacitance		606		pF	V <sub>GS</sub> = 0 V	Fig. 17, 18
C <sub>oss</sub>	Output Capacitance		55			V <sub>DS</sub> = 1000 V	
C <sub>rss</sub>	Reverse Transfer Capacitance		5			f = 1 MHz	
E <sub>oss</sub>	C <sub>oss</sub> Stored Energy		28			V <sub>AC</sub> = 25 mV	
E <sub>AS</sub>	Avalanche Energy, Single Pluse		600		mJ	I <sub>D</sub> = 10A, V <sub>DD</sub> = 50V	Fig. 29
E <sub>ON</sub>	Turn-On Switching Energy		121		μJ	V <sub>DS</sub> = 800 V, V <sub>GS</sub> = -5/20 V, I <sub>D</sub> = 10A, R <sub>G(ext)</sub> = 2.5Ω, L = 434μH	Fig. 25
E <sub>OFF</sub>	Turn Off Switching Energy		48				
t <sub>d(on)</sub>	Turn-On Delay Time		7		ns	V <sub>DD</sub> = 800 V, V <sub>GS</sub> = -5/20 V I <sub>D</sub> = 10 A R <sub>G(ext)</sub> = 2.5 Ω, R <sub>L</sub> = 80 Ω Timing relative to V <sub>DS</sub> Per IEC60747-8-4 pg 83	Fig. 27
t <sub>r</sub>	Rise Time		9				
t <sub>d(off)</sub>	Turn-Off Delay Time		13				
t <sub>f</sub>	Fall Time		14				
R <sub>G(int)</sub>	Internal Gate Resistance		6.5		Ω	f = 1 MHz, V <sub>AC</sub> = 25 mV	
Q <sub>gs</sub>	Gate to Source Charge		11		nC	V <sub>DS</sub> = 800 V, V <sub>GS</sub> = -5/20 V I <sub>D</sub> = 10 A Per IEC60747-8-4 pg 21	Fig. 12
Q <sub>gd</sub>	Gate to Drain Charge		17				
Q <sub>g</sub>	Total Gate Charge		40				

### Reverse Diode Characteristics

Symbol	Parameter	Typ.	Max.	Unit	Test Conditions	Note
V <sub>SD</sub>	Diode Forward Voltage	3.9		V	V <sub>GS</sub> = -5 V, I <sub>F</sub> = 5 A	Fig. 8,9, 10
		3.5			V <sub>GS</sub> = -5V, I <sub>F</sub> = 5 A, T <sub>J</sub> = 150 °C	
I <sub>S</sub>	Continuous Diode Forward Current		25	A	T <sub>C</sub> = 25°C	Note 1
t <sub>rr</sub>	Reverse Recovery Time	20		ns	V <sub>GS</sub> = -5 V, I <sub>SD</sub> = 10 A, V <sub>R</sub> = 800 V dif/dt = 2400 A/μs	Note 1
Q <sub>rr</sub>	Reverse Recovery Charge	192		nC		
I <sub>rrm</sub>	Peak Reverse Recovery Current	16		A		

Note (1): When using SiC Body Diode the maximum recommended V<sub>GS</sub> = -5V

### Thermal Characteristics

Symbol	Parameter	Typ.	Max.	Unit	Test Conditions	Note
R <sub>θJC</sub>	Thermal Resistance from Junction to Case	0.9	1.0	K/W		Fig. 21
R <sub>θJA</sub>	Thermal Resistance From Junction to Ambient		40			

### Typical Performance

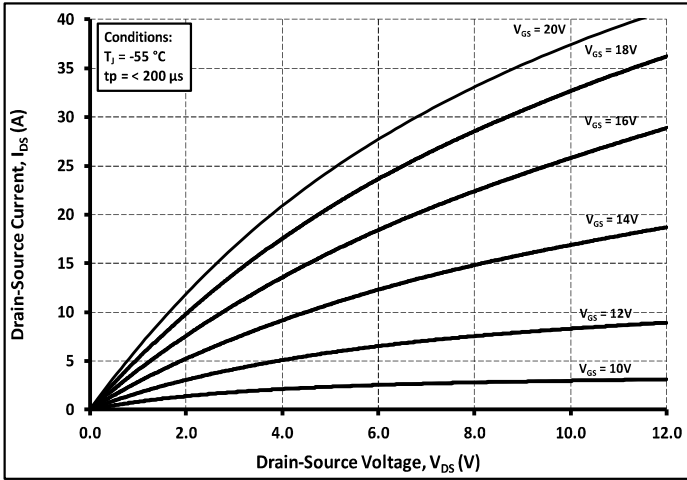

Figure 1. Output Characteristics  $T_J = -55\text{ }^\circ\text{C}$

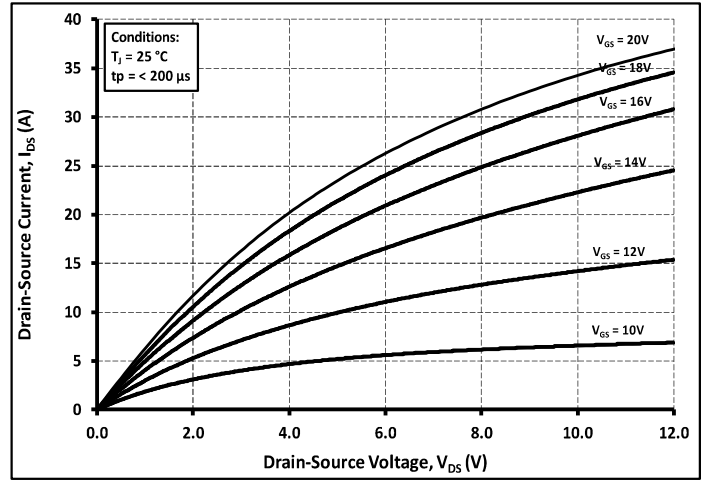

Figure 2. Output Characteristics  $T_J = 25\text{ }^\circ\text{C}$

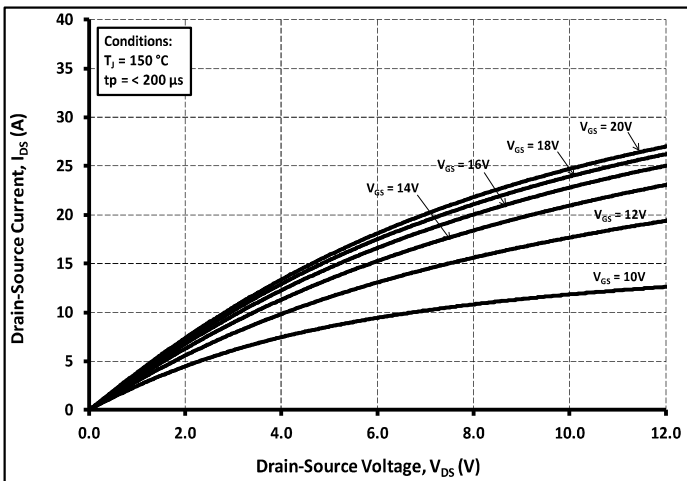

Figure 3. Output Characteristics  $T_J = 150\text{ }^\circ\text{C}$

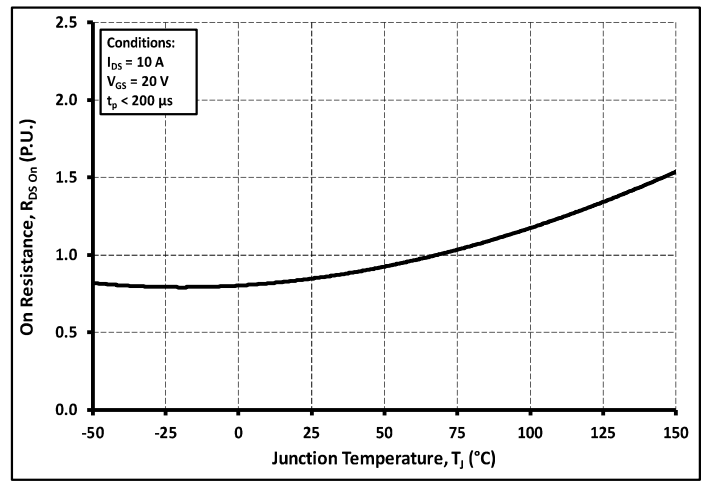

Figure 4. Normalized On-Resistance vs. Temperature

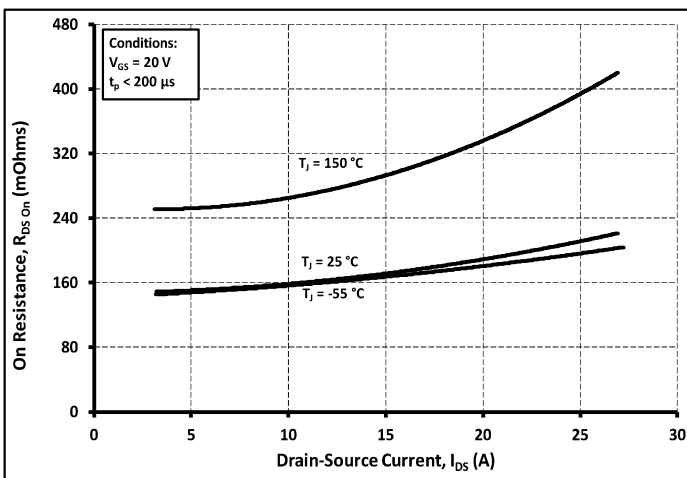

Figure 5. On-Resistance vs. Drain Current For Various Temperatures

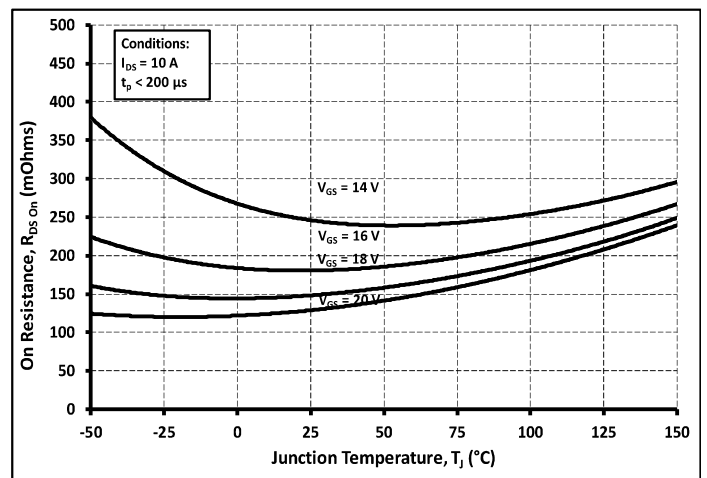

Figure 6. On-Resistance vs. Temperature For Various Gate Voltage

### Typical Performance

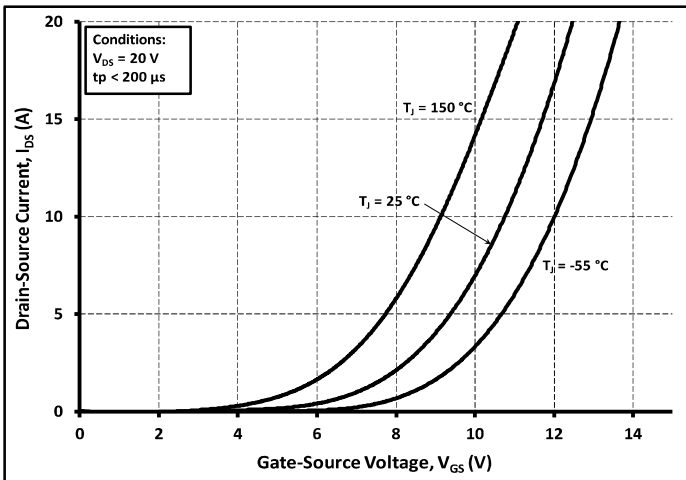

Figure 7. Transfer Characteristic for Various Junction Temperatures

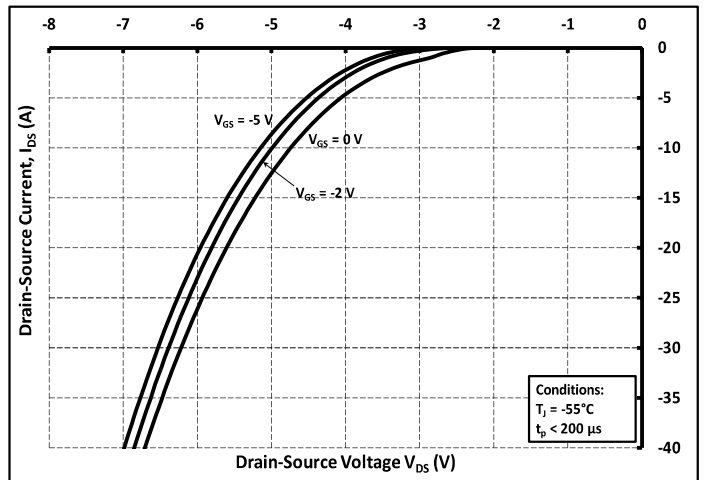

Figure 8. Body Diode Characteristic at -55 °C

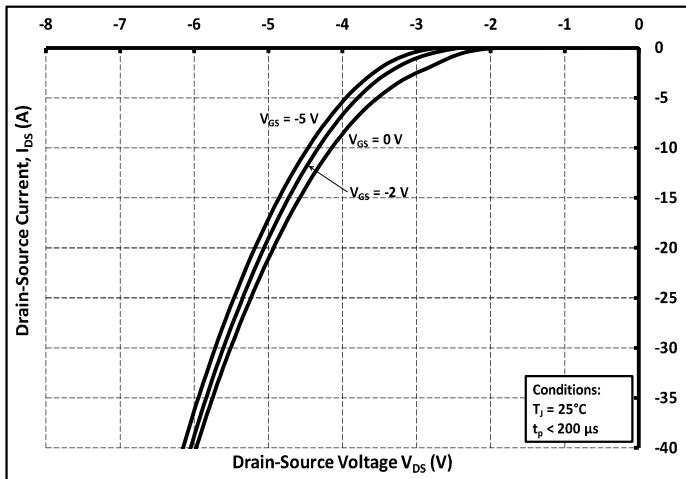

Figure 9. Body Diode Characteristic at 25 °C

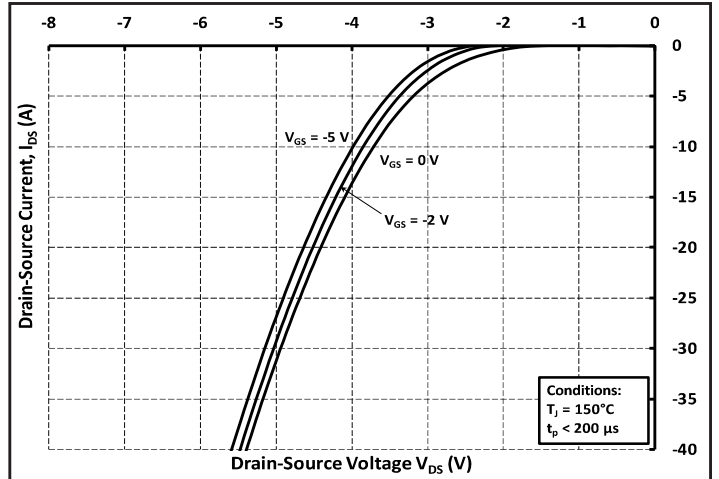

Figure 10. Body Diode Characteristic at 150 °C

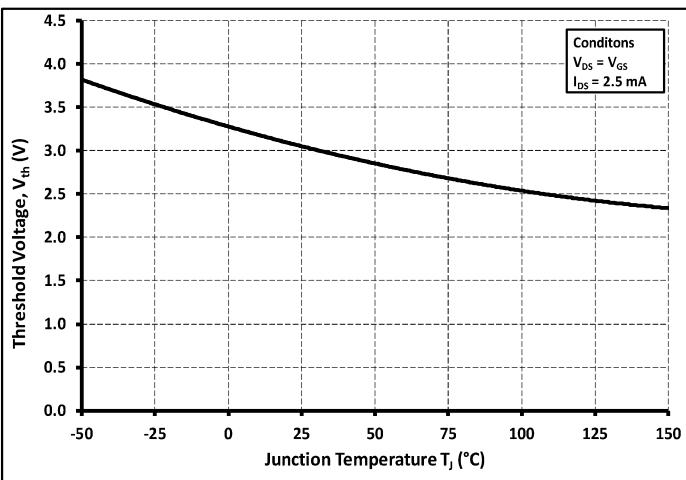

Figure 11. Threshold Voltage vs. Temperature

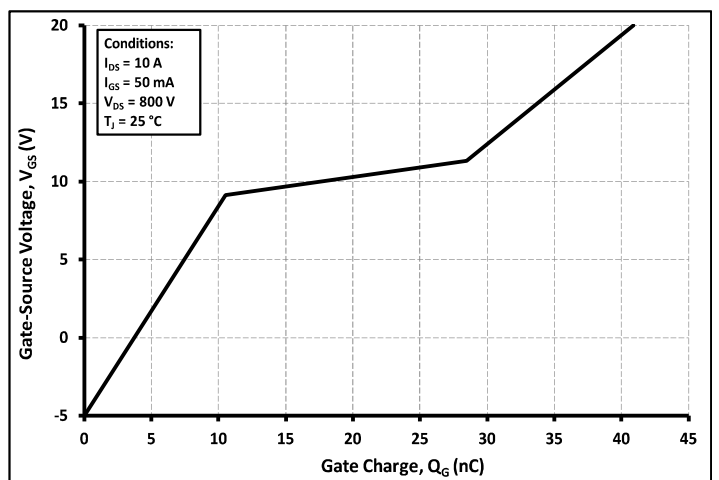

Figure 12. Gate Charge Characteristics

### Typical Performance

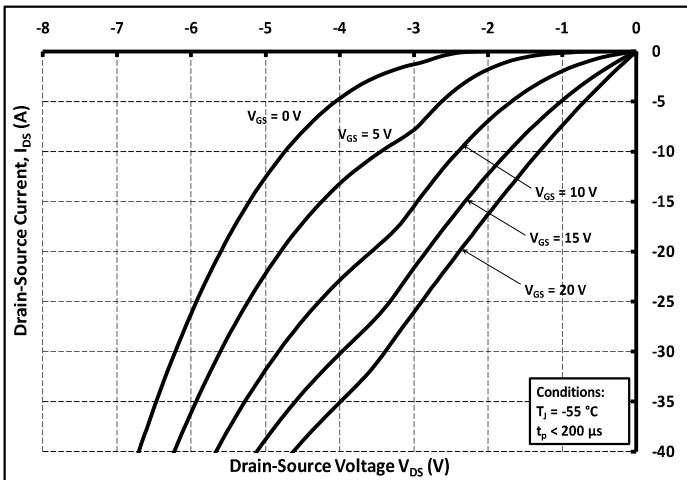

Figure 13. 3rd Quadrant Characteristic at -55 °C

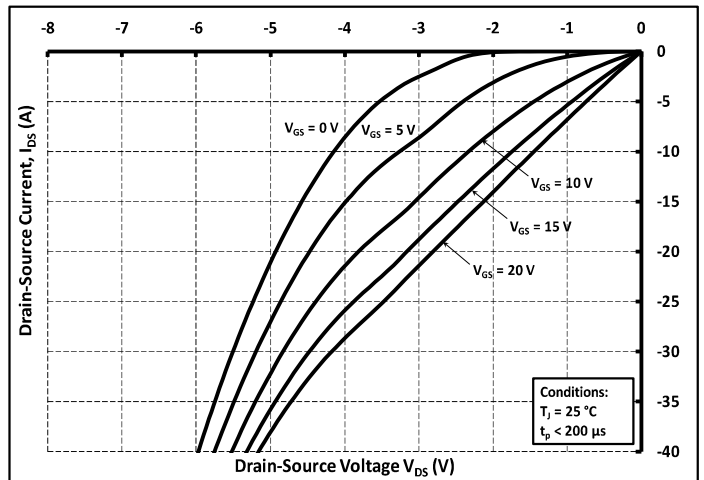

Figure 14. 3rd Quadrant Characteristic at 25 °C

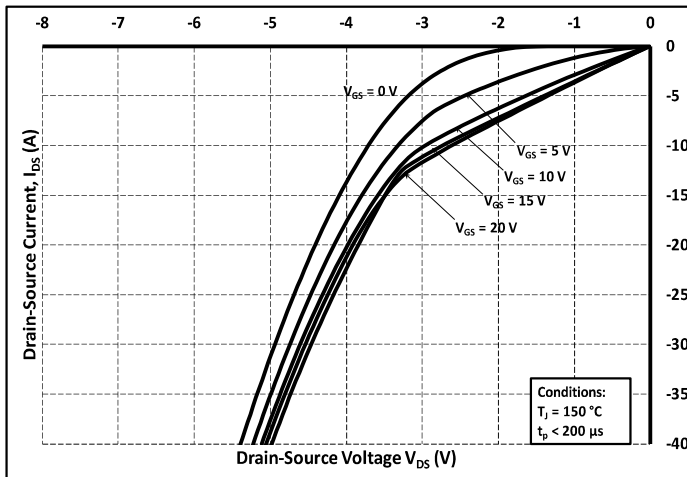

Figure 15. 3rd Quadrant Characteristic at 150 °C

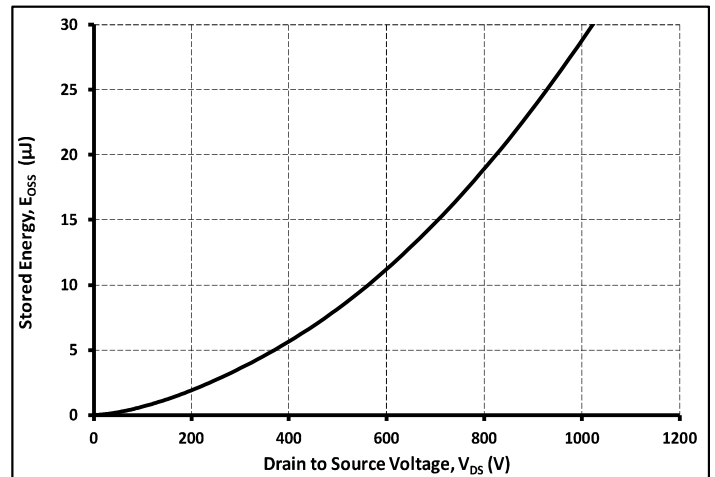

Figure 16. Output Capacitor Stored Energy

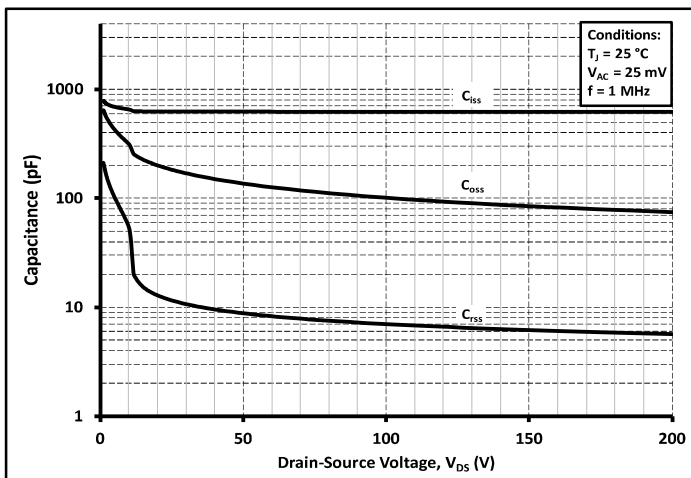

Figure 17. Capacitances vs. Drain-Source Voltage (0 - 200V)

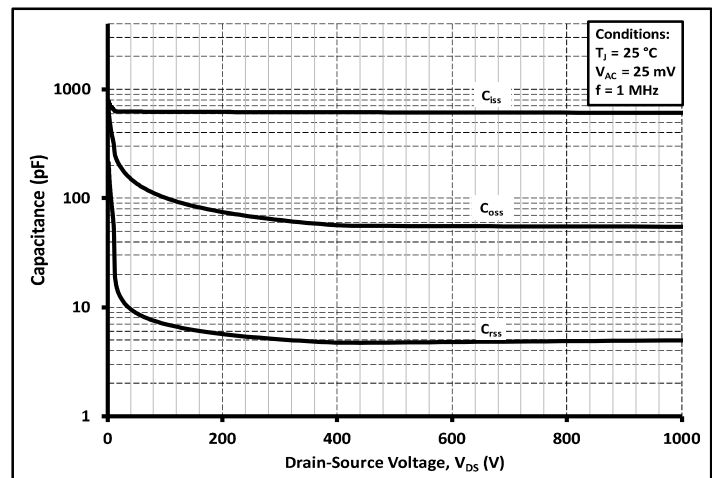

Figure 18. Capacitances vs. Drain-Source Voltage (0 - 1000V)

### Typical Performance

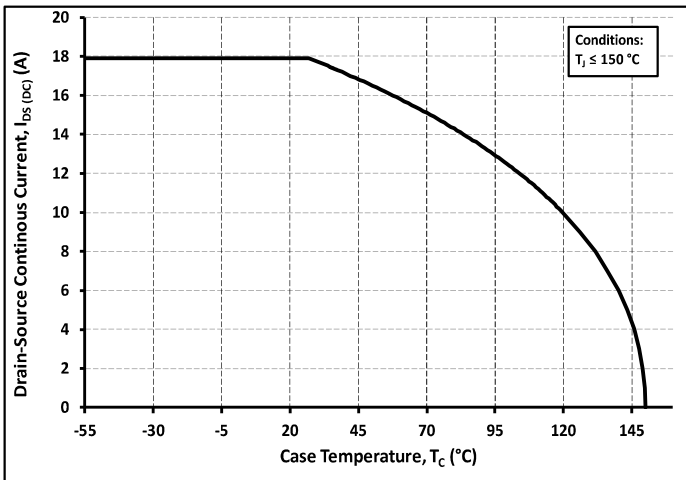

Figure 19. Continuous Drain Current Derating vs. Case Temperature

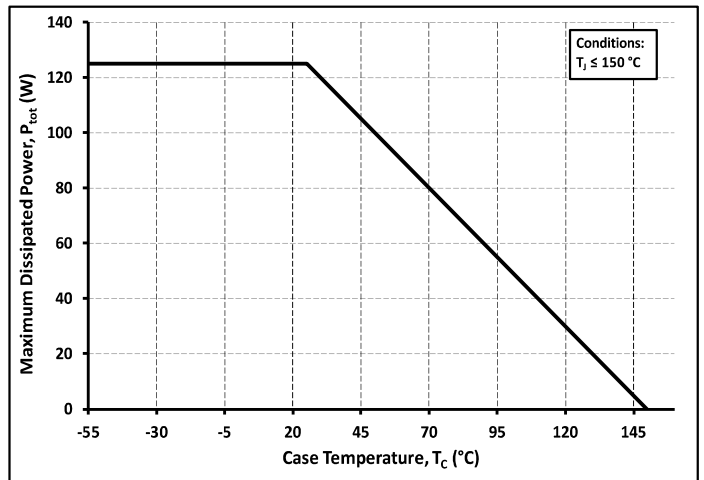

Figure 20. Maximum Power Dissipation Derating vs. Case Temperature

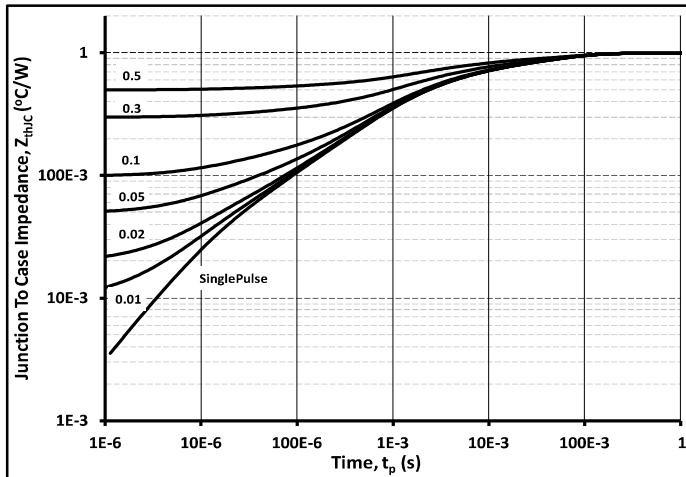

Figure 21. Transient Thermal Impedance (Junction - Case)

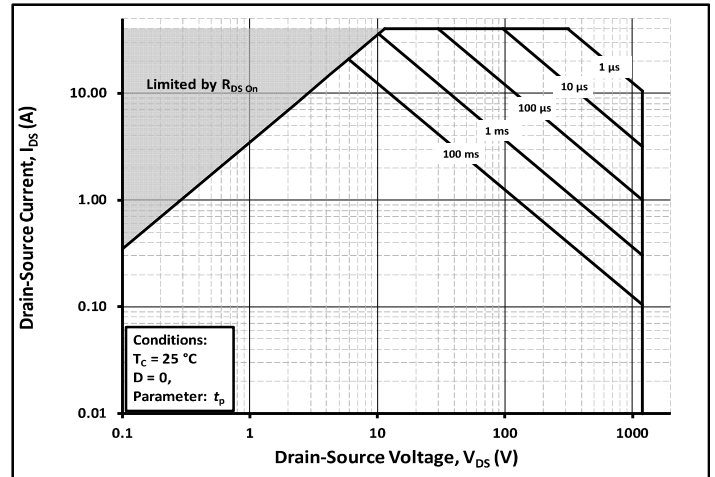

Figure 22. Safe Operating Area

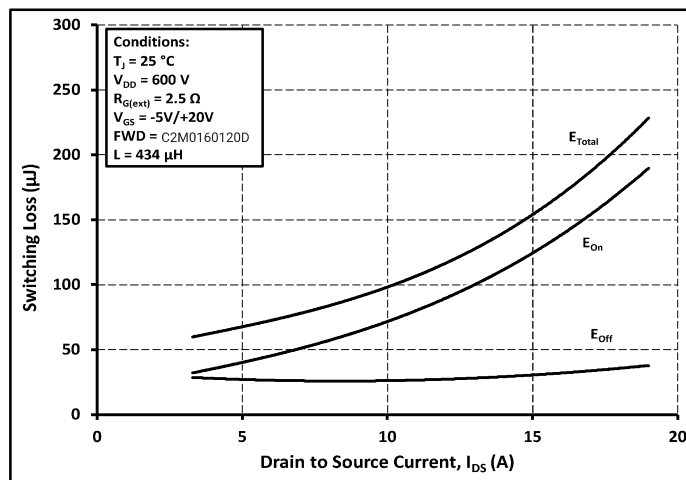

Figure 23. Clamped Inductive Switching Energy vs. Drain Current ( $V_{DS} = 600\text{ V}$ )

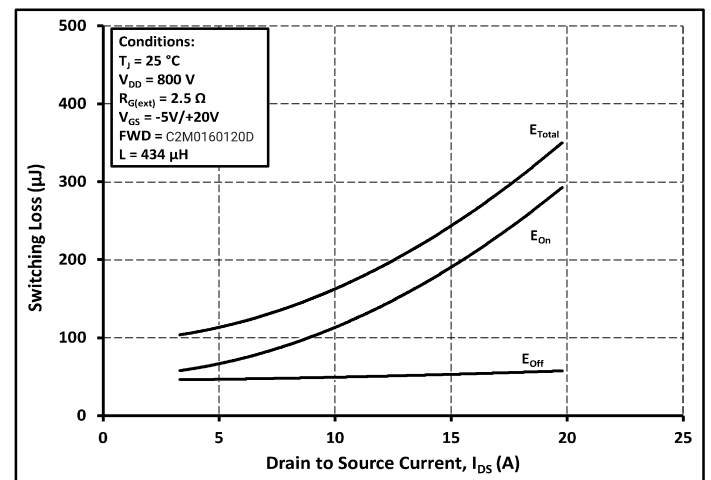

Figure 24. Clamped Inductive Switching Energy vs. Drain Current ( $V_{DS} = 800\text{ V}$ )

### Typical Performance

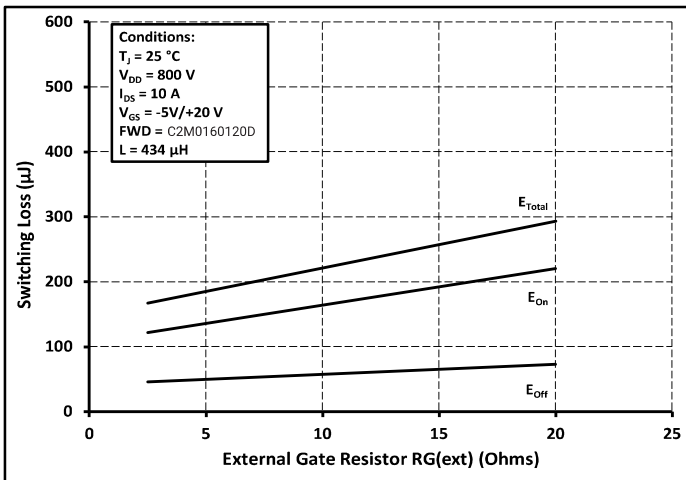

Figure 25. Clamped Inductive Switching Energy vs.  $R_{G(\text{ext})}$

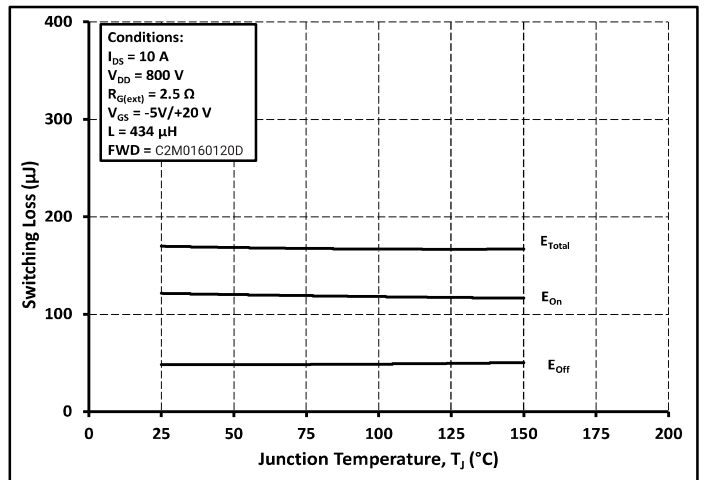

Figure 26. Clamped Inductive Switching Energy vs. Temperature

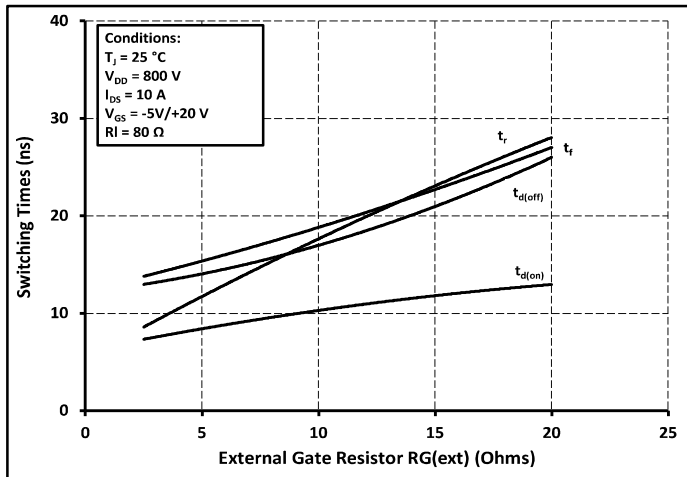

Figure 27. Switching Times vs.  $R_{G(\text{ext})}$

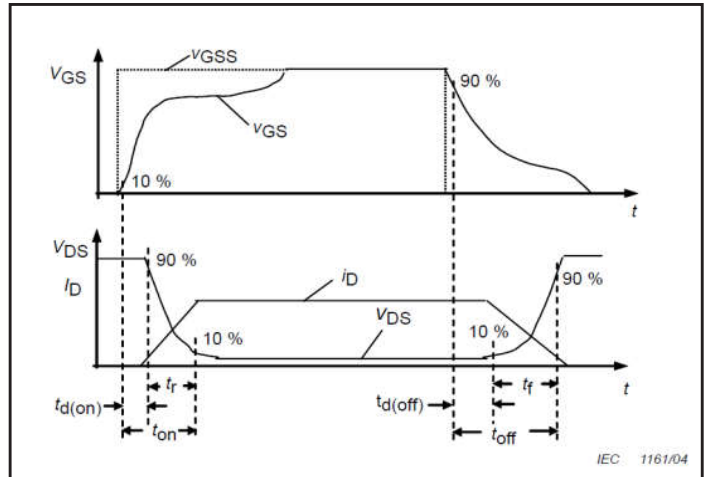

Figure 28. Switching Times Definition

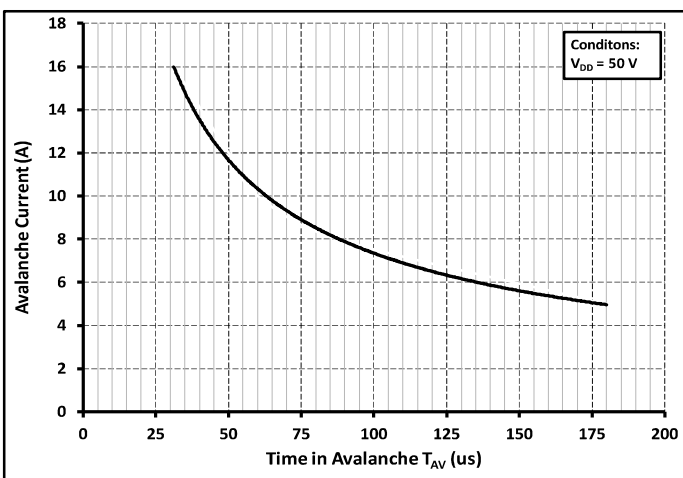

Figure 29. Single Avalanche SOA curve

## Test Circuit Schematic

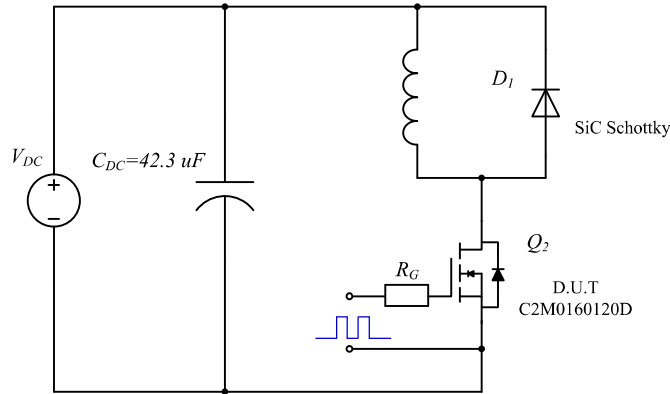

Figure 30. Clamped Inductive Switching Waveform Test Circuit

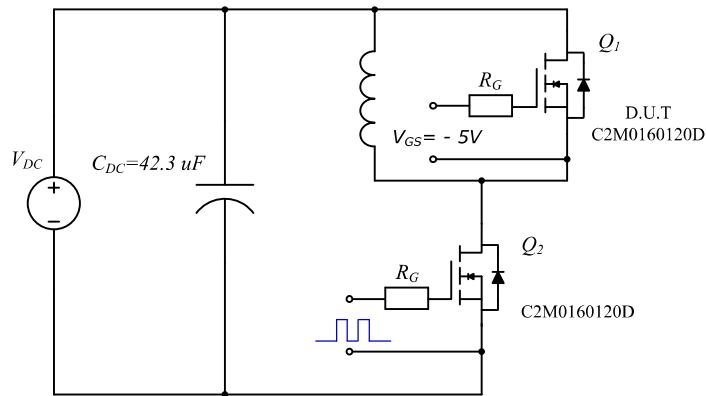

Figure 31. Body Diode Recovery Test Circuit

## ESD Ratings

ESD Test	Total Devices Sampled	Resulting Classification
ESD-HBM	All Devices Passed 1000V	2 (>2000V)
ESD-MM	All Devices Passed 400V	C (>400V)
ESD-CDM	All Devices Passed 1000V	IV (>1000V)



### Package Dimensions

Package TO-247-3

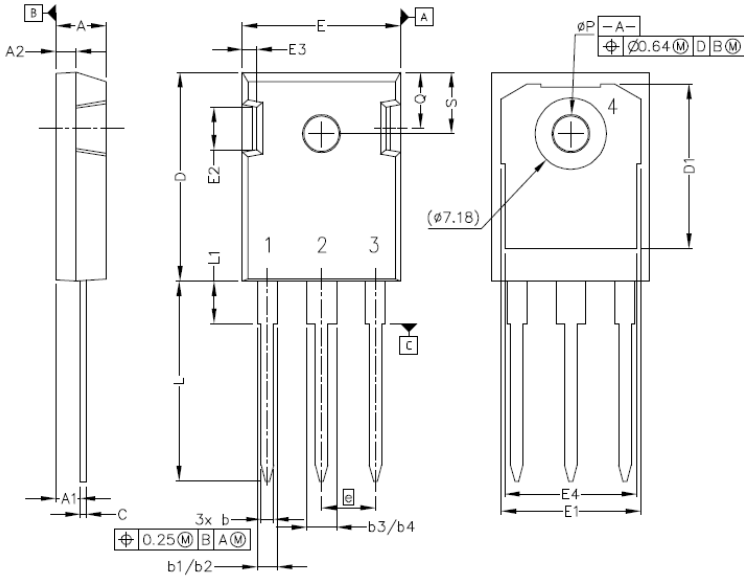

Pinout Information:

- Pin 1 = Gate
- Pin 2, 4 = Drain
- Pin 3 = Source

POS	Inches		Millimeters	
	Min	Max	Min	Max
A	.190	.205	4.83	5.21
A1	.090	.100	2.29	2.54
A2	.075	.085	1.91	2.16
b	.042	.052	1.07	1.33
b1	.075	.095	1.91	2.41
b2	.075	.085	1.91	2.16
b3	.113	.133	2.87	3.38
b4	.113	.123	2.87	3.13
c	.022	.027	0.55	0.68
D	.819	.831	20.80	21.10
D1	.640	.695	16.25	17.65
D2	.037	.049	0.95	1.25
E	.620	.635	15.75	16.13
E1	.516	.557	13.10	14.15
E2	.145	.201	3.68	5.10
E3	.039	.075	1.00	1.90
E4	.487	.529	12.38	13.43
e	.214 BSC		5.44 BSC	
N	3		3	
L	.780	.800	19.81	20.32
L1	.161	.173	4.10	4.40
ØP	.138	.144	3.51	3.65
Q	.216	.236	5.49	6.00
S	.238	.248	6.04	6.30
T	9°	11°	9°	11°
U	9°	11°	9°	11°
V	2°	8°	2°	8°
W	2°	8°	2°	8°

### Recommended Solder Pad Layout

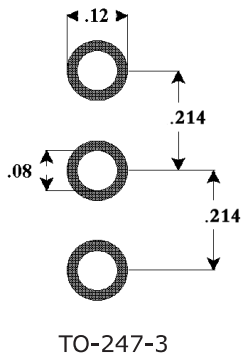

## X-ON Electronics

Largest Supplier of Electrical and Electronic Components

*Click to view similar products for [MOSFET](#) category:*

*Click to view products by [FUXINSEMI](#) manufacturer:*

Other Similar products are found below :

[IRFD120](#) [JANTX2N5237](#) [BUK455-60A/B](#) [MIC4420CM-TR](#) [VN1206L](#) [NDP4060](#) [SI4482DY](#) [IPS70R2K0CEAKMA1](#) [SQD23N06-31L-GE3](#)  
[TK16J60W,S1VQ\(O](#) [2SK2614\(TE16L1,Q\)](#) [DMN1017UCP3-7](#) [DMN1053UCP4-7](#) [SQJ469EP-T1-GE3](#) [NTE2384](#) [DMC2700UDMQ-7](#)  
[DMN2080UCB4-7](#) [DMN61D9UWQ-13](#) [US6M2GTR](#) [DMN31D5UDJ-7](#) [DMP22D4UFO-7B](#) [DMN1006UCA6-7](#) [DMN16M9UCA6-7](#)  
[STF5N65M6](#) [IRF40H233XTMA1](#) [STU5N65M6](#) [DMN6022SSD-13](#) [DMN13M9UCA6-7](#) [DMTH10H4M6SPS-13](#) [DMN2990UFB-7B](#)  
[IPB80P04P405ATMA2](#) [2N7002W-G](#) [MCAC30N06Y-TP](#) [MCQ7328-TP](#) [NTMC083NP10M5L](#) [BXP7N65D](#) [BXP4N65F](#) [AOL1454G](#)  
[WMJ80N60C4](#) [BXP2N20L](#) [BXP2N65D](#) [BXT1150N10J](#) [BXT1700P06M](#) [TSM60NB380CP](#) [ROG](#) [RQ7L055BGTGR](#) [DMNH15H110SK3-13](#)  
[SLF10N65ABV2](#) [BSO203SP](#) [BSO211P](#) [IPA60R230P6](#)