

Features

- ◆ The plastic package carries Underwriters Laboratory Flammability Classification 94V-0
- ◆ Fast switching for high efficiency
- ◆ Low reverse leakage
- ◆ High forward surge current capability
- ◆ High temperature soldering guaranteed:
260°C/10 seconds, 0.375" (9.5mm) lead length, 5 lbs. (2.3kg) tension

Mechanical data

Case: JEDEC DO-41 molded plastic body

Terminals: Plated axial leads, solderable per MIL-STD-750, Method 2026

Polarity: Color band denotes cathode end

Mounting Position: Any

Weight: 0.012 ounce, 0.33 grams

Package outline

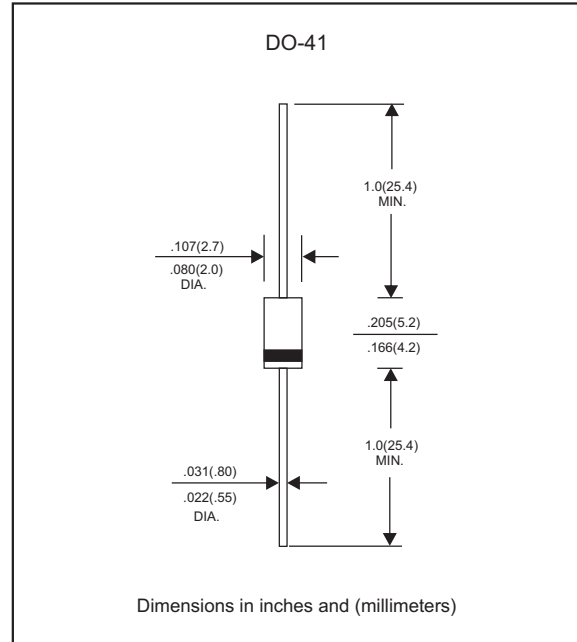

Maximum ratings and Electrical Characteristics (AT $T_A=25^\circ\text{C}$ unless otherwise noted)

	SYMBOLS	FR 101	FR 102	FR 103	FR 104	FR 105	FR 106	FR 107	UNITS
Maximum repetitive peak reverse voltage	V_{RRM}	50	100	200	400	600	800	1000	V
Maximum RMS voltage	V_{RMS}	35	70	140	280	420	560	700	V
Maximum DC blocking voltage	V_{DC}	50	100	200	400	600	800	1000	V
Maximum average forward rectified current 0.375" (9.5mm) lead length at $T_A=75^\circ\text{C}$	$I_{(AV)}$	1.0							A
Peak forward surge current 8.3ms single half sine-wave superimposed on rated load (JEDEC Method)	I_{FSM}	30.0							A
Maximum instantaneous forward voltage at 1.0A	V_F	1.3							V
Maximum DC reverse current $T_A=25^\circ\text{C}$ at rated DC blocking voltage $T_A=100^\circ\text{C}$	I_R	5.0 50.0							μA
Maximum reverse recovery time (NOTE 1)	t_{rr}	150					250	500	ns
Typical junction capacitance (NOTE 2)	C_J	15.0							pF
Typical thermal resistance (NOTE 3)	$R_{\theta JA}$	50.0							$^\circ\text{C/W}$
Operating junction and storage temperature range	T_J, T_{STG}	-55 to +150							$^\circ\text{C}$

Note: 1. Reverse recovery condition $I_F=0.5\text{A}, I_R=1.0\text{A}, I_{rr}=0.25\text{A}$

2. Measured at 1MHz and applied reverse voltage of 4.0V D.C.

3. Thermal resistance from junction to ambient at 0.375" (9.5mm) lead length, P.C.B. mounted

Rating and characteristic curves

FIG.1-TYPICAL FORWARD CHARACTERISTICS

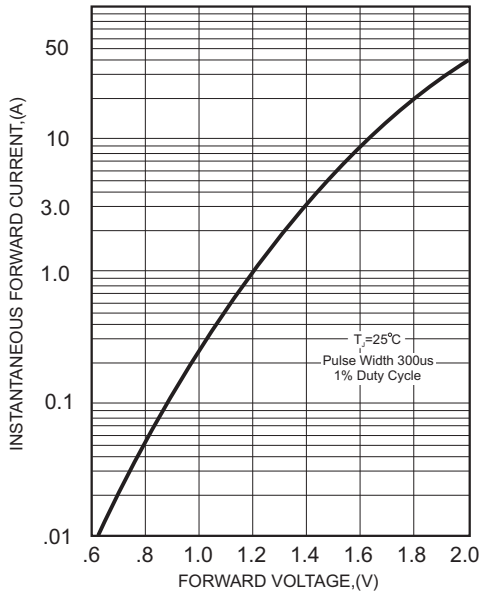

FIG.2-TYPICAL FORWARD CURRENT DERATING CURVE

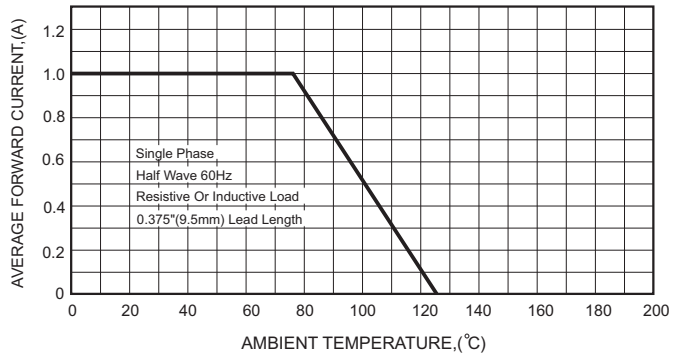

FIG.4-MAXIMUM NON-REPETITIVE FORWARD SURGE CURRENT

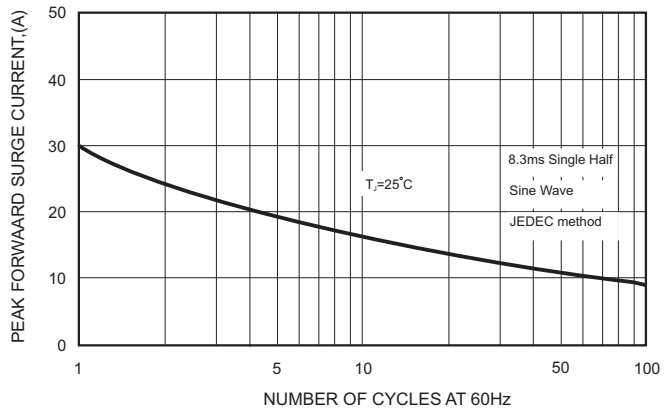
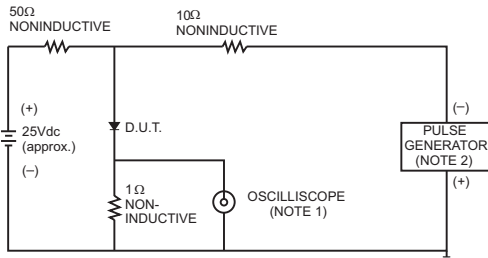

FIG.3- TEST CIRCUIT DIAGRAM AND REVERSE RECOVERY TIME CHARACTERISTICS



NOTES: 1. Rise Time= 7ns max., Input Impedance= 1 megohm.22pF.

2. Rise Time= 10ns max., Source Impedance= 50 ohms.

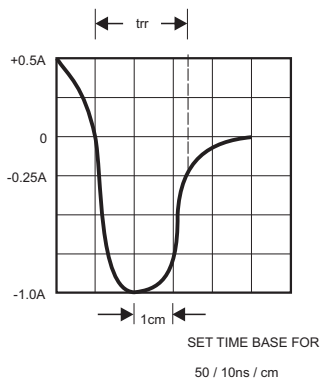
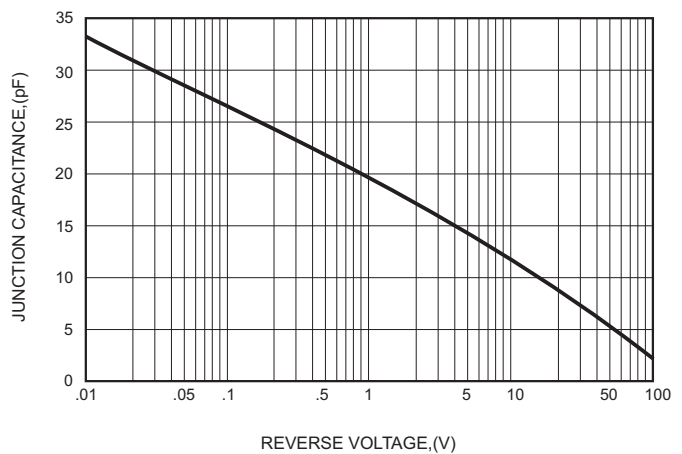



FIG.5-TYPICAL JUNCTION CAPACITANCE



Pinning information

Pin	Simplified outline	Symbol
Pin1 cathode Pin2 anode		

Marking

Type number	Marking code
FR101	FR101
FR102	FR102
FR103	FR103
FR104	FR104
FR105	FR105
FR106	FR106
FR107	FR107

Taping specifications for AXIAL devices

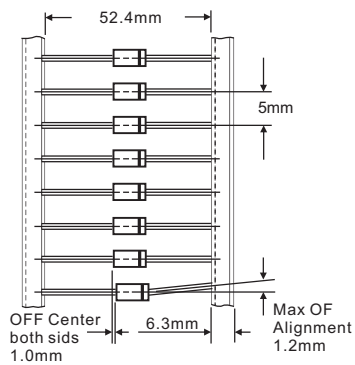

AMMO PACKING

DEVICE CASE TYPE	Q'TY 1 (PCS / BOX)	INNER BOX SIZE (m/m)	CARTON SIZE (m/m)	Q'TY 2 (PCS / CARTON)	APPROX. CROSS WEIGHT(kg)
DO-41	5,000	260 * 83 * 160	440 * 270 * 340	50,000	20.0

Suggested thermal profiles for soldering processes

1. Lead free temperature profile wave-soldering

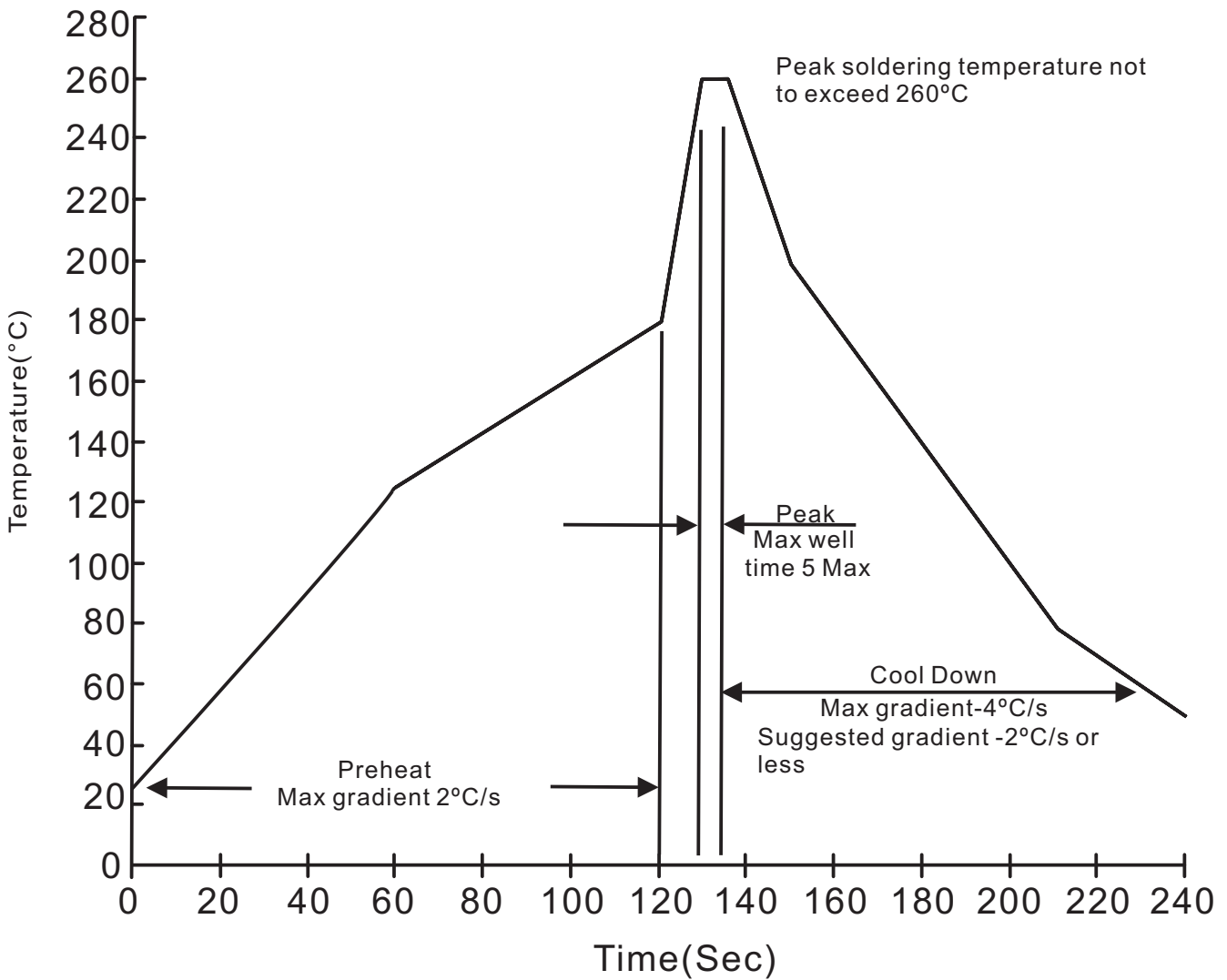

X-ON Electronics

Largest Supplier of Electrical and Electronic Components

Click to view similar products for [Rectifiers](#) category:

Click to view products by [FUXINSEMI](#) manufacturer:

Other Similar products are found below :

[D91A](#) [DA24F4100L](#) [DD89N1600K-A](#) [DD89N16K-K](#) [RL252-TP](#) [DLA11C-TR-E](#) [DSA17G](#) [1N4005-TR](#) [BAV199-TP](#) [UFS120Je3/TR13](#)
[JANS1N6640US](#) [VS-80-1293](#) [DD89N16K](#) [DD89N16K-A](#) [481235F](#) [DSP10G-TR-E](#) [RRE02VS6SGTR](#) [067907F](#) [MS306](#) [ND104N08K](#)
[SPA2003-B-D-A01](#) [VS-80-6193](#) [VS-66-9903](#) [VGF0136AB](#) [US2JFL-TP](#) [UFS105Je3/TR13](#) [A1N5404G-G](#) [ACGRA4007-HF](#) [ACGRB207-HF](#)
[RF301B2STL](#) [RF501B2STL](#) [UES1306](#) [UES1302](#) [BAV199E6433HTMA1](#) [ACGRC307-HF](#) [ACEFC304-HF](#) [JANTXV1N5660A](#) [UES1106](#)
[GS2K-LTP](#) [D126A45C](#) [D251N08B](#) [SCHJ22.5K](#) [SM100](#) [SCPA2](#) [SCH10000](#) [SDHD5K](#) [STTH20P035FP](#) [VS-8EWS12S-M3](#) [VS-](#)
[12FL100S10](#) [ACGRA4001-HF](#)