

## Features

- Ideal for surface mounted application.
- Fast Switching Speed.
- For General Purpose Switching Applications.
- Epitaxial Planar Diode.
- Lead-free parts meet RoHS requirements.

## Mechanical data

- Epoxy : UL94-V0 rated flame retardant
- Case : Molded plastic, SOT-23
- Terminals :Plated terminals, solderable per MIL-STD-750, Method 2026
- Mounting Position : Any

## Package

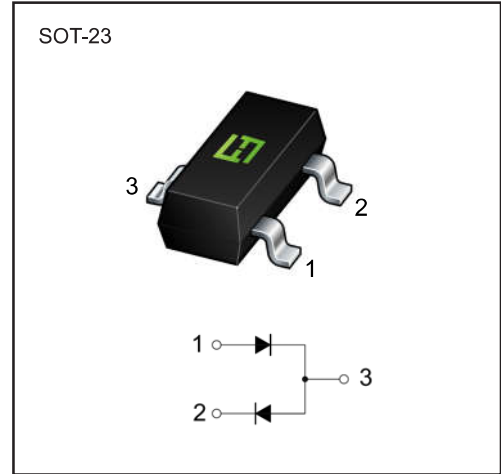

## Maximum Ratings @Ta=25°C

Parameter	Symbol	Limit	Unit
Repetitive peak reverse voltage	$V_{RRM}$	500	V
DC blocking voltage	$V_{DC}$		
Average rectified output current	$I_{F(AV)}$	500	mA
Non-Repetitive Peak Forward Surge Current	$I_{FSM}$	5.0	A
Junction temperature	$T_J$	-55~+150	°C
Storage temperature range	$T_{STG}$	-55~+150	°C

## ELECTRICAL CHARACTERISTICS (Ta=25°C unless otherwise specified)

Parameter	Symbol	Test conditions	Min	Typ	Max	Unit
Reverse breakdown voltage	$V_{(BR)}$	$I_R=100\mu A$	500			V
Reverse voltage leakage current	$I_R$	$V_R=600V$			10	$\mu A$
Forward voltage	$V_F$	$I_F=300mA$			1.5	V
Diode capacitance	$C_T$	$V_R=0V, f=1MHz$		5		pF
Reveres recovery time	$t_{rr}$	$I_F=I_R=10mA, I_{tr}=0.1 \times I_R$		80		ns

## Rating and characteristic curves

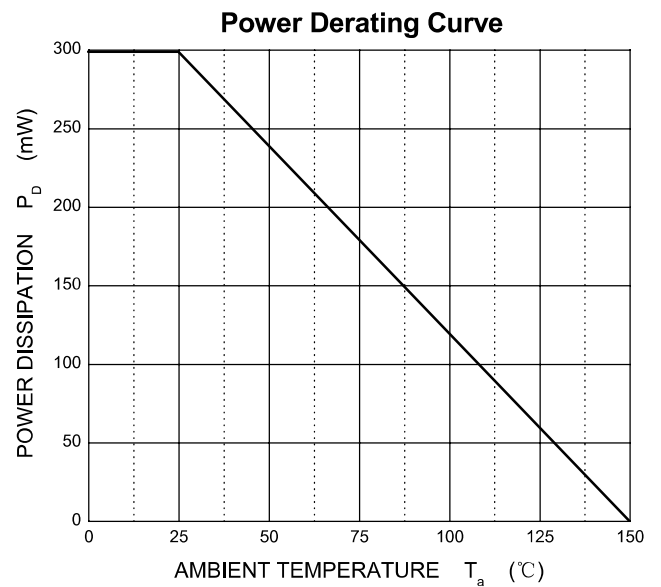
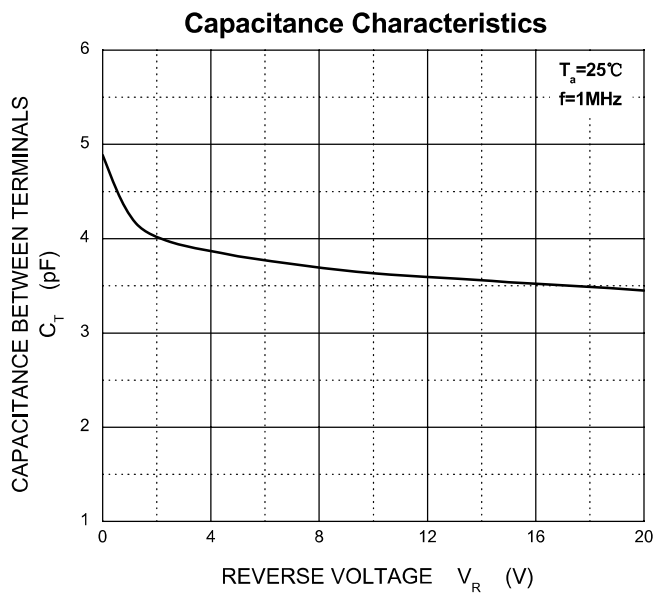
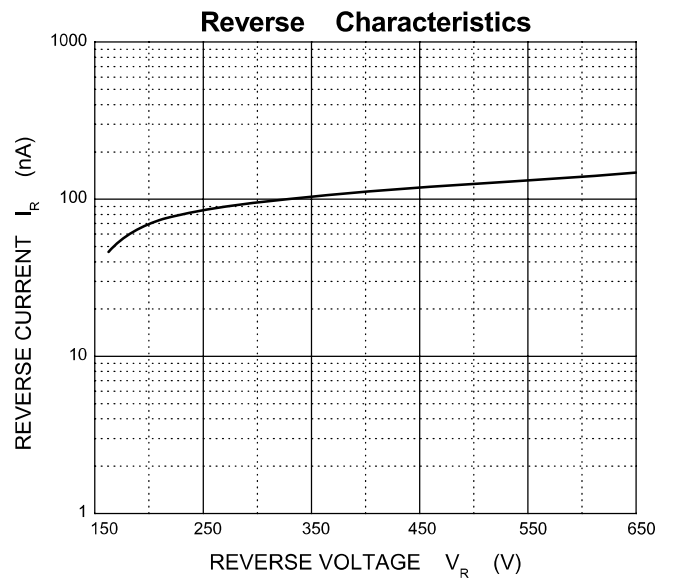
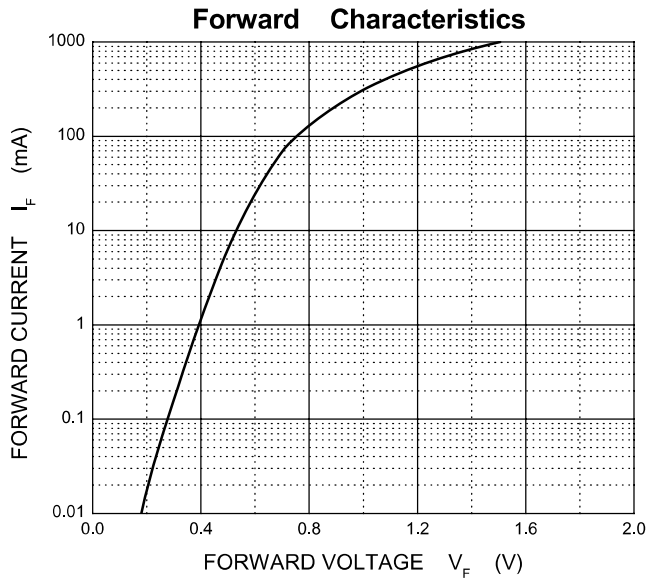

**Pinning information**

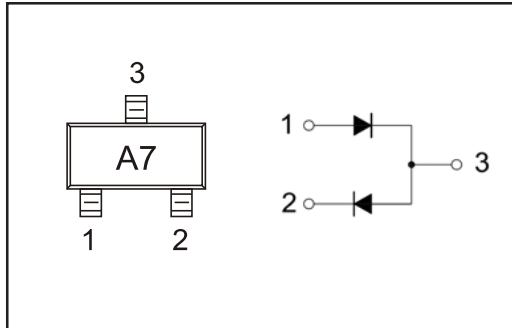

**Package Outline**

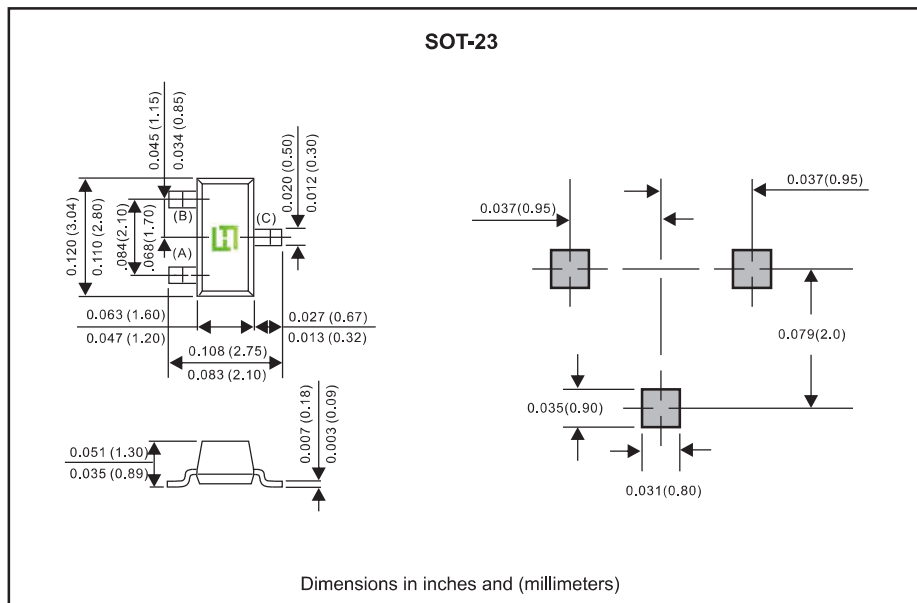

**Suggested thermal profiles for soldering processes**

- 1.Storage environment: Temperature=5°C~40°C Humidity=55%±25%
- 2.Reflow soldering of surface-mount devices

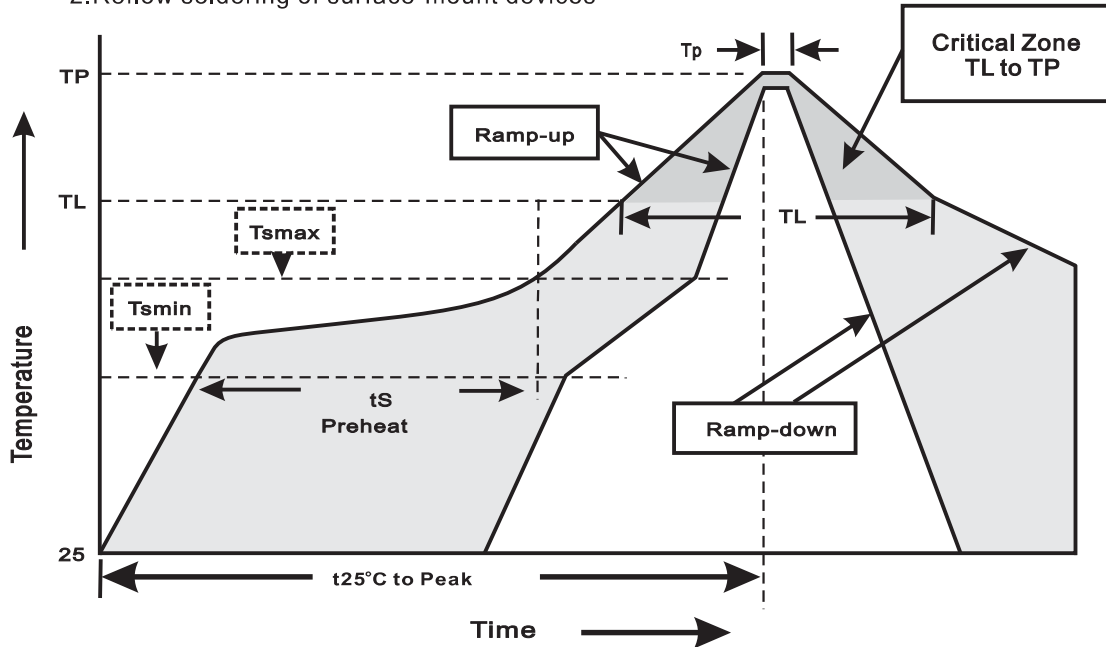

3.Reflow soldering

Profile Feature	Soldering Condition
Average ramp-up rate(TL to TP)	<3°C/sec
Preheat -Temperature Min(Tsmin) -Temperature Max(Tsmax) -Time(min to max)(ts)	150°C 200°C 60~120sec
Tsmax to TL -Ramp-upRate	<3°C/sec
Time maintained above: -Temperature(TL) -Time(tL)	217°C 60~260sec
Peak Temperature(TP)	255°C-0/+5°C
Time within 5°C of actual Peak Temperature(tp)	10~30sec
Ramp-down Rate	<6°C/sec
Time 25°C to Peak Temperature	<6minutes

## X-ON Electronics

Largest Supplier of Electrical and Electronic Components

*Click to view similar products for [Diodes - General Purpose, Power, Switching category](#):*

*Click to view products by [FUXINSEMI manufacturer](#):*

Other Similar products are found below :

[MMBD3004S-13-F](#) [1N3611](#) [NTE156A](#) [NTE6244](#) [1SS400CST2RA](#) [SDAA13](#) [SHN2D02FUTW1T1G](#) [1N4449](#) [1N456A](#) [1N914BTR](#)  
[D291S45T](#) [BAS 16-02L E6327](#) [BAS 16-02V H6327](#) [BAS 21U E6327](#) [BAS 28 E6327](#) [BAW56DWQ-7-F](#) [BAW56M3T5G](#) [BAW75-TAP](#)  
[MM230L-CAA](#) [IDW40E65D1](#) [JAN1N3600](#) [JAN1N4454UR-1](#) [SMMSD4148T3G](#) [BYW95B/A52A](#) [NSVDAN222T1G](#) [CDSZC01100-HF](#)  
[BAV70HDW-7](#) [BAS28-7](#) [JANTX1N6640](#) [BAW56HDW-13](#) [BAS28 TR](#) [VS-HFA04SD60STR-M3](#) [1SS388-TP](#) [BAV99TQ-13-F](#)  
[BAV99HDW-13](#) [1N4004](#) [MMDB30-E28X](#) [LS4148](#) [IDV15E65D2](#) [W0503RH200S0L](#) [W0503SH200S0L](#) [M0268SJ200NLF](#)  
[M0268RJ200NLF](#) [S3MBF](#) [US1J](#) [DAN217U-TP](#) [SHV-06JNS-Q](#) [IDW30C65D1](#) [IDW80C65D1](#) [VS-HFA30TA60CSR-M3](#)