

Features

- 600W peak pulse power capability with a 10/1000 μ s waveform, repetition rate (duty cycle): 0.01%.
- Low profile surface mounted application in order to optimize board space.
- Excellent clamping capability.
- Low incremental surge resistance.
- Fast response time from 0V to VBR, typically less than 1 ps for uni-directional & 5 ns for bi-directional types.
- Glass passivated chip junction.
- Lead-free parts meet RoHS requirements.
- Compliant to Halogen-free

Mechanical data

- Epoxy: UL94-V0 rated flame retardant
- Case : Molded plastic, DO-214AA / SMB
- Terminals : Solder plated, solderable per MIL-STD-750, Method 2026
- Polarity : Indicated by cathode band
- Mounting Position : Any

Package outline

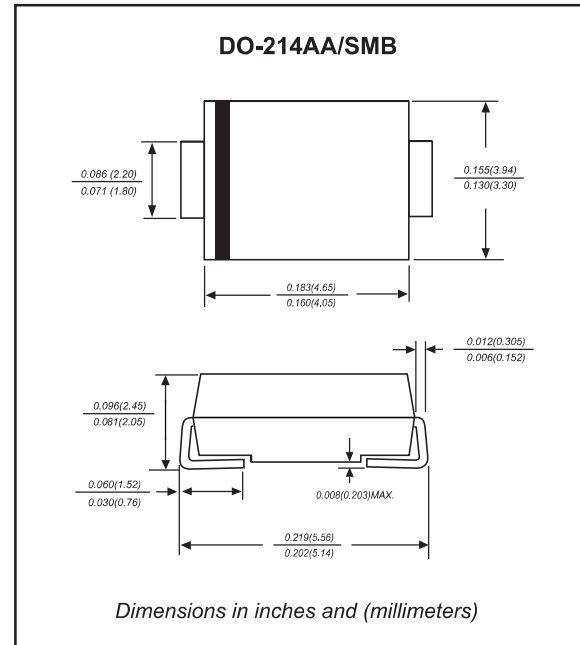

Maximum ratings (AT $T_A=25^\circ\text{C}$ unless otherwise noted)

PARAMETER	CONDITIONS	Symbol	MIN.	TYP.	MAX.	UNIT
Peak power dissipation	with a 10/1000 μ s waveform, Note 1 & Fig. 1	P_{PPM}			600	W
Peak pulse current	with a 10/1000 μ s waveform	I_{PPM}	See table 1			A
Steady state power dissipation	at $T_L=75^\circ\text{C}$ lead length 0.375" (9.5 mm)	$P_{M(AV)}$			5.0	W
Peak forward surge current	8.3ms single half sine-wave superimposed on rated load (jedec method), note 2	I_{FSM}			100	A
Maximum instantaneous forward voltage	for uni-directional types only, at 50A, see note 3	V_F			3.5/5.0	V
Operating junction temperature range		T_J	-55		+150	$^\circ\text{C}$
Storage temperature range		T_{STG}	-55		+150	$^\circ\text{C}$

Note 1. Non-repetitive current pulse, per Fig. 3 and derated above $T_A=25^\circ\text{C}$ per Fig. 2

2. Measured on 8.3 ms single half sine-wave or equivalent square wave, duty cycle=4 pulses per minute maximum

3. $V_F < 3.5\text{V}$. for devices of $V_{BR} < 200\text{V}$, and $V_F < 5.0\text{V}$. for devices of $V_{BR} > 201\text{V}$

Electrical characteristics (at $T_A=25^\circ\text{C}$ unless otherwise noted)

Type Number		Reverse Stand-Off Voltage	Breakdown Voltage Min. @ I_T	Breakdown Voltage Max. @ I_T	Test Current	Maximum Clamping Voltage @ I_{PP}	Peak Pulse Current	Reverse Leakage @ V_{RMW}
(Uni)	(Bi)	$V_{RMW}(V)$	$V_{BR\ MIN}(V)$	$V_{BR\ MAX}(V)$	$I_T\ (mA)$	$V_C(V)$	$I_{PP}(A)$	$I_R(\mu A)$
SM6T6V8A	SM6T6V8CA	5.80	6.45	7.14	10.0	10.5	57.1	800.0
SM6T7V5A	SM6T7V5CA	6.40	7.13	7.88	10.0	11.3	53.1	500.0
SM6T8V2A	SM6T8V2CA	7.02	7.79	8.61	10.0	12.1	49.6	200.0
SM6T9V1A	SM6T9V1CA	7.78	8.65	9.55	1.0	13.4	44.8	50.0
SM6T10A	SM6T10CA	8.55	9.50	10.5	1.0	14.5	41.4	10.0
SM6T11A	SM6T11CA	9.40	10.5	11.6	1.0	15.6	38.5	5.0
SM6T12A	SM6T12CA	10.2	11.4	12.6	1.0	16.7	35.9	5.0
SM6T13A	SM6T13CA	11.1	12.4	13.7	1.0	18.2	33.0	5.0
SM6T15A	SM6T15CA	12.8	14.3	15.8	1.0	21.2	28.3	5.0
SM6T16A	SM6T16CA	13.6	15.2	16.8	1.0	22.5	26.7	5.0
SM6T18A	SM6T18CA	15.3	17.1	18.9	1.0	25.2	23.8	5.0
SM6T20A	SM6T20CA	17.1	19.0	21.0	1.0	27.7	21.7	5.0
SM6T22A	SM6T22CA	18.8	20.9	23.1	1.0	30.6	19.6	5.0
SM6T24A	SM6T24CA	20.5	22.8	25.2	1.0	33.2	18.1	5.0
SM6T27A	SM6T27CA	23.1	25.7	28.4	1.0	37.5	16.0	5.0
SM6T30A	SM6T30CA	25.6	28.5	31.5	1.0	41.4	14.5	5.0
SM6T33A	SM6T33CA	28.2	31.4	34.7	1.0	45.7	13.1	5.0
SM6T36A	SM6T36CA	30.8	34.2	37.8	1.0	49.9	12.0	5.0
SM6T39A	SM6T39CA	33.3	37.1	41.0	1.0	53.9	11.1	5.0
SM6T43A	SM6T43CA	36.8	40.9	45.2	1.0	59.3	10.1	5.0
SM6T47A	SM6T47CA	40.2	44.7	49.4	1.0	64.8	9.3	5.0
SM6T51A	SM6T51CA	43.6	48.5	53.6	1.0	70.1	8.6	5.0
SM6T56A	SM6T56CA	47.8	53.2	58.8	1.0	77.0	7.8	5.0
SM6T62A	SM6T62CA	53.0	58.9	65.1	1.0	85.0	7.1	5.0
SM6T68A	SM6T68CA	58.1	64.6	71.4	1.0	92.0	6.5	5.0
SM6T75A	SM6T75CA	64.1	71.3	78.8	1.0	103	5.8	5.0
SM6T82A	SM6T82CA	70.1	77.9	86.1	1.0	113	5.3	5.0
SM6T91A	SM6T91CA	77.8	86.5	95.5	1.0	125	4.8	5.0
SM6T100A	SM6T100CA	85.5	95.0	105	1.0	137	4.4	5.0
SM6T110A	SM6T110CA	94.0	105	116	1.0	152	3.9	5.0
SM6T120A	SM6T120CA	102	114	126	1.0	165	3.6	5.0
SM6T130A	SM6T130CA	111	124	137	1.0	179	3.4	5.0

※ For Bi-directional type having VRWM of 10 Volts and less, the IR limit is double

Electrical characteristics (at $T_A = 25^\circ\text{C}$ unless otherwise noted)

Type Number		Reverse Stand-Off Voltage	Breakdown Voltage Min. @ I_T	Breakdown Voltage Max. @ I_T	Test Current	Maximum Clamping Voltage @ I_{PP}	Peak Pulse Current	Reverse Leakage @ V_{RMW}
(Uni)	(Bi)	$V_{RMW}(V)$	$V_{BR\ MIN}(V)$	$V_{BR\ MAX}(V)$	$I_T\ (mA)$	$V_C(V)$	$I_{PP}(A)$	$I_R(\mu A)$
SM6T150A	SM6T150CA	128	143	158	1.0	207	2.9	5.0
SM6T160A	SM6T160CA	136	152	168	1.0	219	2.7	5.0
SM6T170A	SM6T170CA	145	162	179	1.0	234	2.6	5.0
SM6T180A	SM6T180CA	154	171	189	1.0	246	2.4	5.0
SM6T200A	SM6T200CA	171	190	210	1.0	274	2.2	5.0
SM6T220A	SM6T220CA	185	209	231	1.0	328	1.8	5.0
SM6T250A	SM6T250CA	214	237	263	1.0	344	1.7	5.0
SM6T300A	SM6T300CA	256	285	315	1.0	414	1.4	5.0
SM6T350A	SM6T350CA	300	333	368	1.0	482	1.2	5.0
SM6T400A	SM6T400CA	342	380	420	1.0	548	1.1	5.0
SM6T440A	SM6T440CA	376	418	462	1.0	602	1.0	5.0

※ For Bi-directional type having V_{RWM} of 10 Volts and less, the I_R limit is double

Rating and characteristic curves

Fig.1 - PEAK PULSE POWER RATING CURVE

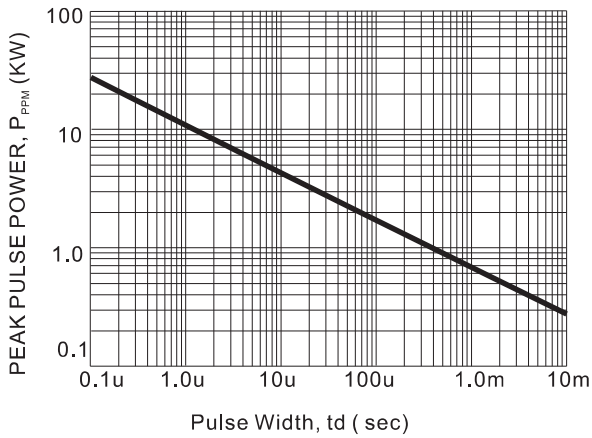

Fig.2 - PULSE DERATING CURVE

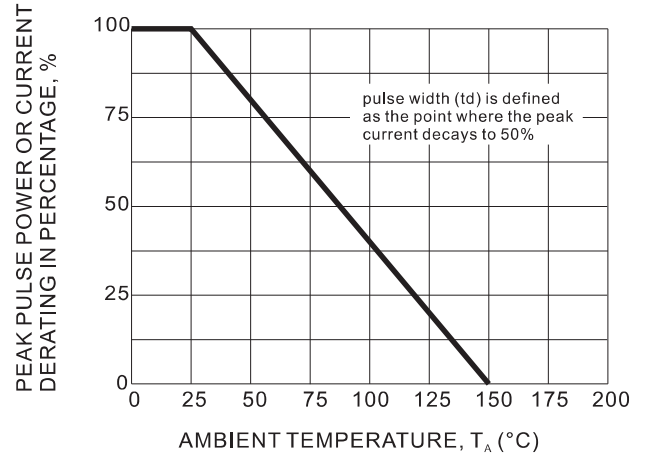

Fig.3 - PULSE WAVEFORM

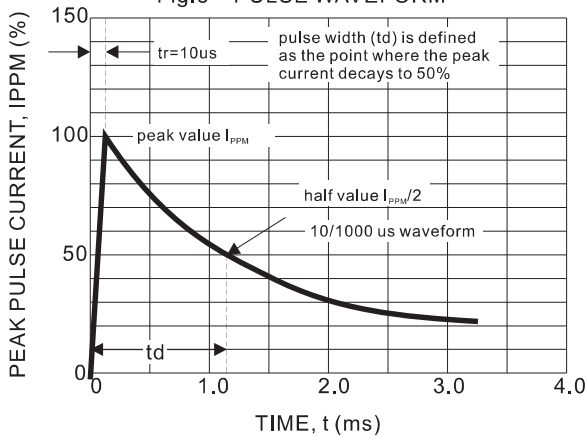

Fig.4 - TYPICAL JUNCTION CAPACITANCE

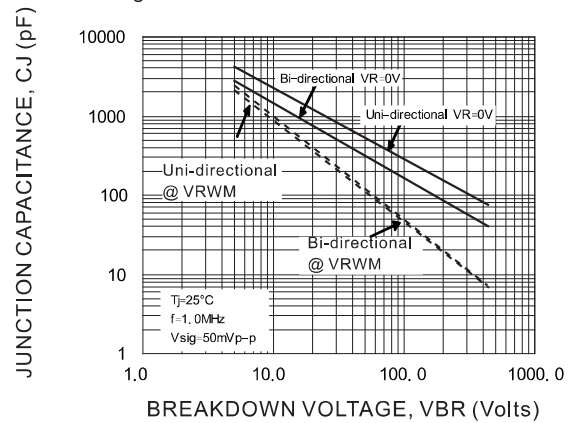

Fig.5 - STEADY STATE POWER DERATING CURVE

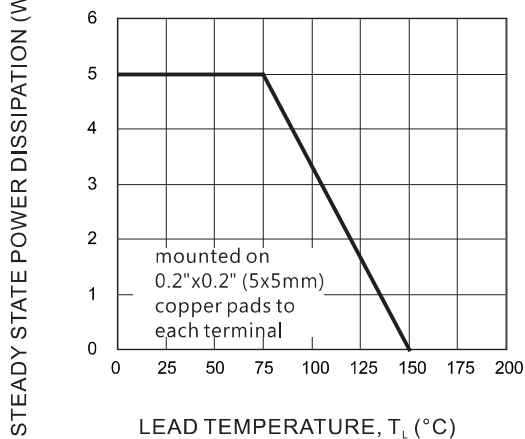
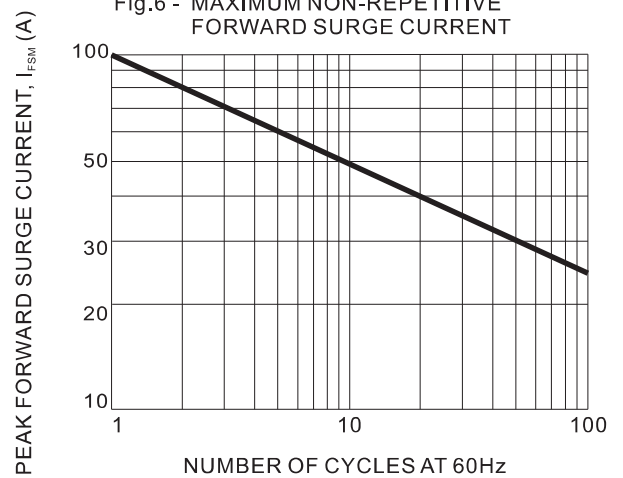

Fig.6 - MAXIMUM NON-REPETITIVE FORWARD SURGE CURRENT



Pinning information

Pin	Simplified outline	Symbol
Uni-Directional Pin1 cathode Pin2 anode		
Bi-Directional		

Marking

Type number	Example
Uni-Directional	
Bi-Directional	

Suggested solder pad layout

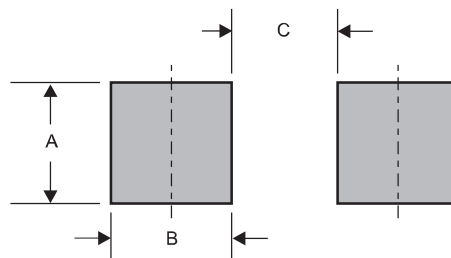

Dimensions in inches and (millimeters)

PACKAGE	A	B	C
SMB	0.078 (2.00)	0.059 (1.50)	0.110 (2.80)

X-ON Electronics

Largest Supplier of Electrical and Electronic Components

Click to view similar products for [ESD Suppressors / TVS Diodes](#) category:

Click to view products by [FUXINSEMI](#) manufacturer:

Other Similar products are found below :

[60KS200C](#) [D18V0L1B2LP-7B](#) [D5V0F4U5P5-7](#) [NTE4902](#) [P4KE27CA](#) [P6KE11CA](#) [P6KE8.2A](#) [SA60CA](#) [SA64CA](#) [SMBJ12CATR](#)
[SMBJ33CATR](#) [SMBJ6.5A](#) [SMBJ8.0A](#) [ESD101-B1-02ELS](#) [E6327](#) [ESD112-B1-02EL](#) [E6327](#) [ESD7451N2T5G](#) [19180-510](#) [CPDT-5V0USP-](#)
[HF](#) [3.0SMCJ33CA-F](#) [3.0SMCJ36A-F](#) [HSPC16701B02TP](#) [JANTX1N6126A](#) [D3V3Q1B2DLP3-7](#) [D55V0M1B2WS-7](#) [SCM1293A-04SO](#)
[ESD200-B1-CSP0201](#) [E6327](#) [SM12-7](#) [CEN955](#) [W/DATA](#) [VESD12A1A-HD1-GS08](#) [CPDQC5V0-HF](#) [D1213A-01LP4-7B](#) [ESD101-B1-02EL](#)
[E6327](#) [AOZ8808DI-03](#) [5KP15A](#) [5KP48A](#) [5KP90A](#) [ESD3V3D7-TP](#) [15KPA36A-LF](#) [P4KE56CA](#) [P4KE68A](#) [P4KE91CATR](#) [P6KE120A](#)
[P6KE13CA](#) [P6KE43CA](#) [P6KE6.8CA](#) [P6KE8.2](#) [P6SMBJ20CA](#) [JANTX1N6072A](#) [SR2835ESKG](#) [SA90CA](#)