

## Features

- 600W peak pulse power capability with a 10/1000  $\mu$ s waveform, repetition rate (duty cycle): 0.01%.
- Low profile surface mounted application in order to optimize board space.
- Excellent clamping capability.
- Low incremental surge resistance.
- Fast response time from 0V to VBR, typically less than 1 ps for uni-directional & 5 ns for bi-directional types.
- Glass passivated chip junction.
- Lead-free parts meet RoHS requirements.
- Compliant to Halogen-free

## Mechanical data

- Epoxy:UL94-V0 rated flame retardant
- Case : Molded plastic, DO-214AA / SMB
- Terminals : Solder plated, solderable per MIL-STD-750, Method 2026
- Polarity : Indicated by cathode band
- Mounting Position : Any

## Package outline

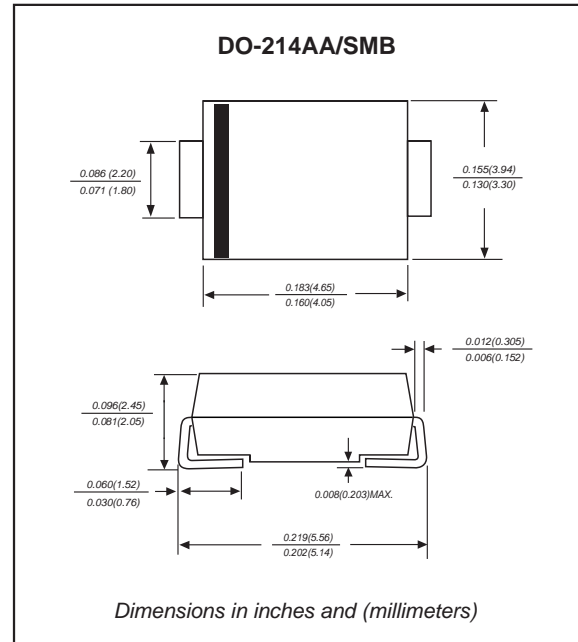

## Maximum ratings (AT $T_A=25^\circ\text{C}$ unless otherwise noted)

PARAMETER	CONDITIONS	Symbol	Value	UNIT
Peak Power Dissipation	with a 10/1000 $\mu$ s waveform, Note 1, 2 & Fig. 1	$P_{PPM}$	600	W
Peak Pulse current	with a 10/1000 $\mu$ s waveform	$I_{PPM}$	See Table 1	A
Steady State Power Dissipation	at $T_L=75^\circ\text{C}$ , Note 2	$P_{M(AV)}$	5.0	W
Peak Forward Surge Current	8.3ms Single Half Sine-Wave, Note 3	$I_{FSM}$	100	A
Maximum Instantaneous Forward Voltage	at 50A For Uni-Directional Types Only, Note 4	$V_F$	3.5/5.0	V
Typical Thermal resistance	Junction to case Junction to ambient	$R_{\theta JC}$ $R_{\theta JA}$	30 50	$^\circ\text{C/W}$
Operating junction temperature range		$T_J$	-55 ~ +150	$^\circ\text{C}$
Storage temperature range		$T_{STG}$	-55 ~ +150	$^\circ\text{C}$

Note 1. Non-repetitive current pulse, per Fig. 3 and derated above  $T_A=25^\circ\text{C}$  per Fig. 2

2. Mounted on copper pad area of 0.2"x0.2" (5.0x5.0 mm) per Fig 5

3. Measured on 8.3 ms single half sine-wave or equivalent square wave, duty cycle=4 pulses per minute maximum

4.  $V_F < 3.5\text{V}$  for  $V_{BR} < 200\text{V}$  and  $V_F < 5.0\text{V}$  for  $V_{BR} > 201\text{V}$ .

### Electrical characteristics (at T<sub>A</sub>=25°C unless otherwise noted)

Part No. (Uni)	Part No. (Bi)	Reverse Stand-off Voltage	Breakdown Voltage @I <sub>T</sub>		Test Current	Maximum Clamping Voltage @I <sub>PP</sub>		Maximum Reverse Leakage Current	Marking Code	
		V <sub>RWM</sub>	V <sub>BR Min</sub>	V <sub>BR Max</sub>	I <sub>T</sub>	V <sub>c</sub>	I <sub>PP</sub>	I <sub>R</sub> @V <sub>RWM</sub>		
		Volts	Volts	Volts	mA	Volts	A	µA	UNI	BI
SMBJ 5.0A	SMBJ 5.0CA	5.0	6.40	7.00	10	9.2	65.2	800	KE	AE
SMBJ 6.0A	SMBJ 6.0CA	6.0	6.67	7.37	10	10.3	58.3	800	KG	AG
SMBJ 6.5A	SMBJ 6.5CA	6.5	7.22	7.98	10	11.2	53.6	500	KK	AK
SMBJ 7.0A	SMBJ 7.0CA	7.0	7.78	8.60	10	12.0	50.0	200	KM	AM
SMBJ 7.5A	SMBJ 7.5CA	7.5	8.33	9.21	1.0	12.9	46.5	100	KP	AP
SMBJ 8.0A	SMBJ 8.0CA	8.0	8.89	9.83	1.0	13.6	44.1	50	KR	AR
SMBJ 8.5A	SMBJ 8.5CA	8.5	9.44	10.4	1.0	14.4	41.7	20	KT	AT
SMBJ 9.0A	SMBJ 9.0CA	9.0	10.0	11.1	1.0	15.4	39.0	10	KV	AV
SMBJ 10A	SMBJ 10CA	10	11.1	12.3	1.0	17.0	35.3	5	KX	AX
SMBJ 11A	SMBJ 11CA	11	12.2	13.5	1.0	18.2	33.0	5	KZ	AZ
SMBJ 12A	SMBJ 12CA	12	13.3	14.7	1.0	19.9	30.2	5	LE	BE
SMBJ 13A	SMBJ 13CA	13	14.4	15.9	1.0	21.5	27.9	5	LG	BG
SMBJ 14A	SMBJ 14CA	14	15.6	17.2	1.0	23.2	25.9	5	LK	BK
SMBJ 15A	SMBJ 15CA	15	16.7	18.5	1.0	24.4	24.6	5	LM	BM
SMBJ 16A	SMBJ 16CA	16	17.8	19.7	1.0	26.0	23.0	5	LP	BP
SMBJ 17A	SMBJ 17CA	17	18.9	20.9	1.0	27.6	21.7	5	LR	BR
SMBJ 18A	SMBJ 18CA	18	20.0	22.1	1.0	29.2	20.5	5	LT	BT
SMBJ 20A	SMBJ 20CA	20	22.2	24.5	1.0	32.4	18.5	5	LV	BV
SMBJ 22A	SMBJ 22CA	22	24.4	26.9	1.0	35.5	16.9	5	LX	BX
SMBJ 24A	SMBJ 24CA	24	26.7	29.5	1.0	38.9	15.4	5	LZ	BZ
SMBJ 26A	SMBJ 26CA	26	28.9	31.9	1.0	42.1	14.3	5	ME	CE
SMBJ 28A	SMBJ 28CA	28	31.1	34.4	1.0	45.4	13.2	5	MG	CG
SMBJ 30A	SMBJ 30CA	30	33.3	36.8	1.0	48.4	12.4	5	MK	CK
SMBJ 33A	SMBJ 33CA	33	36.7	40.6	1.0	53.3	11.3	5	MM	CM
SMBJ 36A	SMBJ 36CA	36	40.0	44.2	1.0	58.1	10.3	5	MP	CP
SMBJ 40A	SMBJ 40CA	40	44.4	49.1	1.0	64.5	9.3	5	MR	CR
SMBJ 43A	SMBJ 43CA	43	47.8	52.8	1.0	69.4	8.6	5	MT	CT
SMBJ 45A	SMBJ 45CA	45	50.0	55.3	1.0	72.7	8.3	5	MV	CV
SMBJ 48A	SMBJ 48CA	48	53.3	58.9	1.0	77.4	7.8	5	MX	CX
SMBJ 51A	SMBJ 51CA	51	56.7	62.7	1.0	82.4	7.3	5	MZ	CZ
SMBJ 54A	SMBJ 54CA	54	60.0	66.3	1.0	87.1	6.9	5	NE	DE
SMBJ 58A	SMBJ 58CA	58	64.4	71.2	1.0	93.6	6.4	5	NG	DG
SMBJ 60A	SMBJ 60CA	60	66.7	73.7	1.0	96.8	6.2	5	NK	DK
SMBJ 64A	SMBJ 64CA	64	71.1	78.6	1.0	103.0	5.8	5	NM	DM
SMBJ 70A	SMBJ 70CA	70	77.8	86.0	1.0	113.0	5.3	5	NP	DP
SMBJ 75A	SMBJ 75CA	75	83.3	92.1	1.0	121.0	5.0	5	NR	DR
SMBJ 78A	SMBJ 78CA	78	86.7	95.8	1.0	126.0	4.8	5	NT	DT
SMBJ 85A	SMBJ 85CA	85	94.4	104	1.0	137.0	4.4	5	NV	DV

**Electrical characteristics** (at  $T_A=25^\circ\text{C}$  unless otherwise noted)

Part No. (Uni)	Part No. (Bi)	Reverse Stand-off Voltage	Breakdown Voltage @ $I_T$		Test Current	Maximum Clamping Voltage @ $I_{PP}$		Maximum Reverse Leakage Current	Marking Code	
		$V_{RWM}$	$V_{BR Min}$	$V_{BR Max}$	$I_T$	$V_c$	$I_{PP}$	$I_r @ V_{RWM}$		
		Volts	Volts	Volts	mA	Volts	A	$\mu\text{A}$	UNI	BI
SMBJ 90A	SMBJ 90CA	90	100	111	1.0	146.0	4.1	5	NX	DX
SMBJ 100A	SMBJ 100CA	100	111	123	1.0	162.0	3.7	5	NZ	DZ
SMBJ 110A	SMBJ 110CA	110	122	135	1.0	177.0	3.4	5	PE	EE
SMBJ 120A	SMBJ 120CA	120	133	147	1.0	193.0	3.1	5	PG	EG
SMBJ 130A	SMBJ 130CA	130	144	159	1.0	209.0	2.9	5	PK	EK
SMBJ 150A	SMBJ 150CA	150	167	185	1.0	243.0	2.5	5	PM	EM
SMBJ 160A	SMBJ 160CA	160	178	197	1.0	259.0	2.3	5	PP	EP
SMBJ 170A	SMBJ 170CA	170	189	209	1.0	275.0	2.2	5	PR	ER
SMBJ 180A	SMBJ 180CA	180	201	222	1.0	292.0	2.1	5	PT	ET
SMBJ 200A	SMBJ 200CA	200	224	247	1.0	324.0	1.9	5	PX	EX
SMBJ 220A	SMBJ 220CA	220	246	272	1.0	356.0	1.7	5	PV	EV
SMBJ 250A	SMBJ 250CA	250	279	309	1.0	405.0	1.5	5	PZ	EZ
SMBJ 300A	SMBJ 300CA	300	335	371	1.0	486.0	1.3	5	QE	FE
SMBJ 350A	SMBJ 350CA	350	391	432	1.0	567.0	1.1	5	QG	FG
SMBJ 400A	SMBJ 400CA	400	447	494	1.0	648.0	0.9	5	QK	FK
SMBJ 440A	SMBJ 440CA	440	492	543	1.0	713.0	0.9	5	QM	FM

- Note 1.  $V_{BR}$  measured after  $I_T$  applied for 300us,  $I_T$ =square wave pulse or equivalent  
 2. Surge current waveform per Fig. 3 and derated per Fig. 2  
 3. For bi-directional types having  $V_{RWM}$  of 10 volts and less, the  $I_r$  limit is doubled  
 4. Suffix 'C' denotes bi-directional devices. Suffix 'A' denotes 5% tolerance devices, no suffix denotes 10% tolerance devices.

Fig. a - Transients of several thousand volts can be clamped to a safe level by the TVS

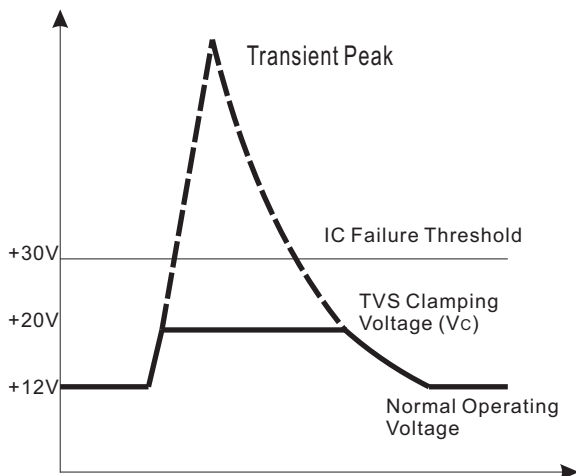
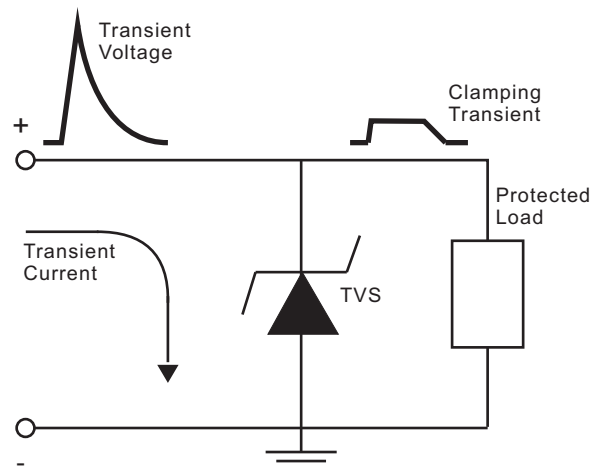

Fig. b - Transient current is diverted to ground thru TVS; the voltage seen by the protected load is limited to the clamping voltage level



## Rating and characteristic curves

Fig.1 - Peak Pulse Power Rating Curve

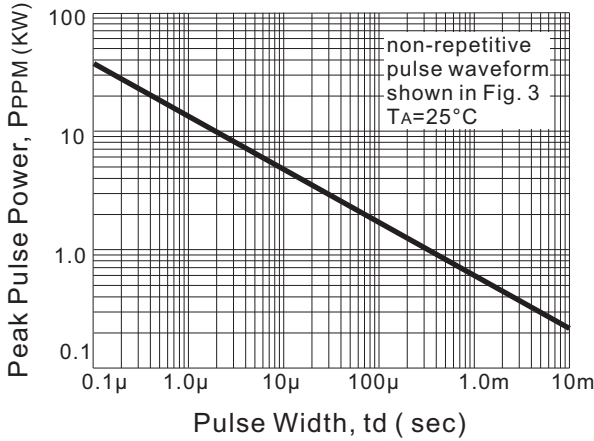

Fig.2 - Pulse Derating Curve

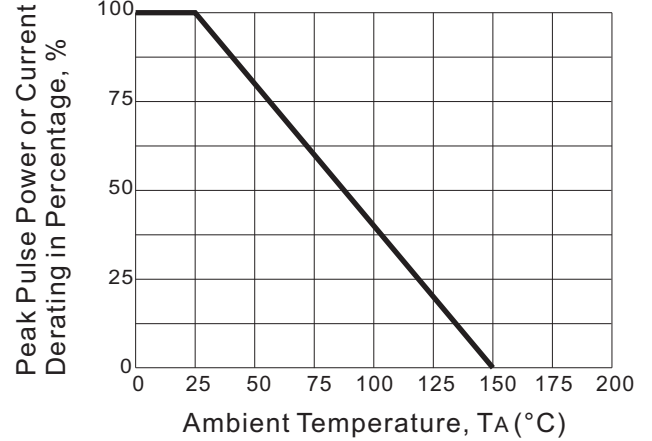

Fig.3 - Pulse Waveform

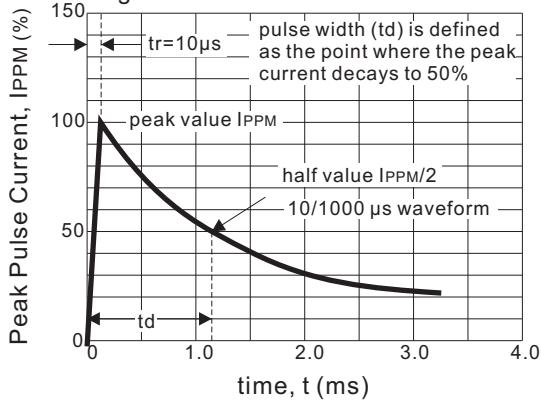

Fig.4 - Typical Junction Capacitance

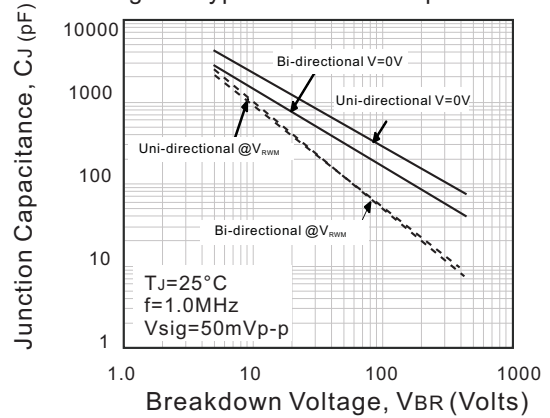

Fig.5 - Steady State Power Derating Curve

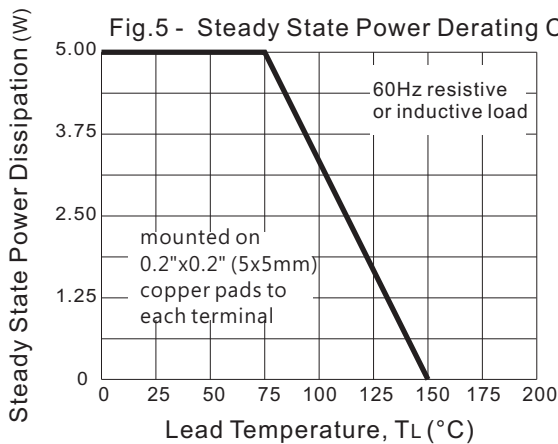
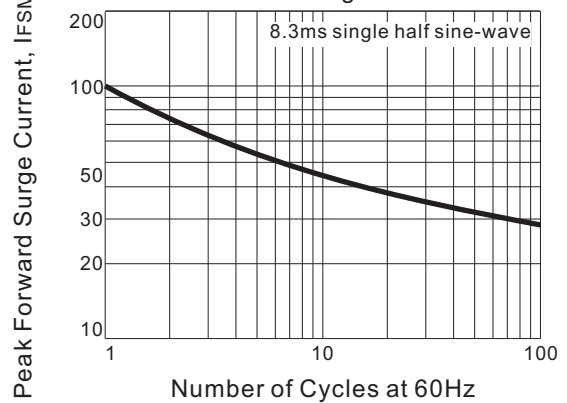

Fig.6 - Maximum Non-Repetitive Forward Surge Current



## Pinning information

Pin	Simplified outline	Symbol
Uni-Directional Pin1 cathode Pin2 anode		
Bi-Directional		

## Marking

Type number	Example
Uni-Directional	
Bi-Directional	

## Suggested solder pad layout

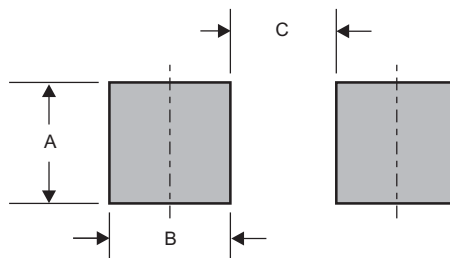

Dimensions in inches and (millimeters)

PACKAGE	A	B	C
SMB	0.078 (2.00)	0.059 (1.50)	0.110 (2.80)

## Suggested thermal profiles for soldering processes

- 1.Storage environment: Temperature=5°C~40°C Humidity=55%±25%
- 2.Reflow soldering of surface-mount devices

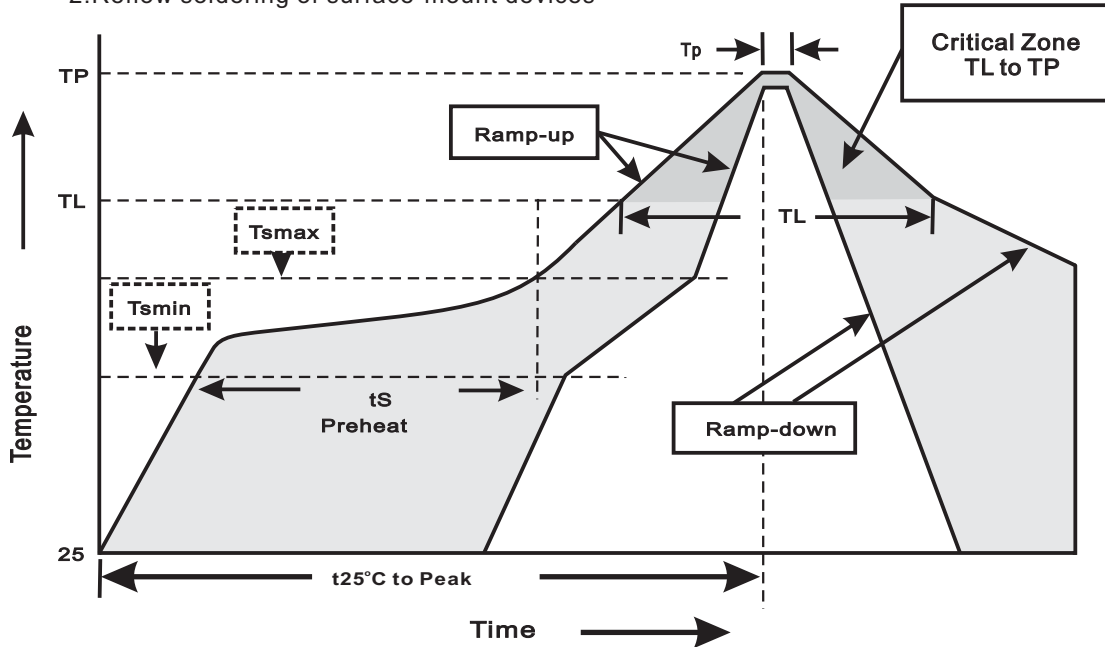

### 3.Reflow soldering

Profile Feature	Soldering Condition
Average ramp-up rate(TL to TP)	<3°C/sec
Preheat -Temperature Min(Tsmin) -Temperature Max(Tsmax) -Time(min to max)(ts)	150°C 200°C 60~120sec
Tsmax to TL -Ramp-upRate	<3°C/sec
Time maintained above: -Temperature(TL) -Time(tL)	217°C 60~260sec
Peak Temperature(TP)	255°C-0/+5°C
Time within 5°C of actual Peak Temperature(tp)	10~30sec
Ramp-down Rate	<6°C/sec
Time 25°C to Peak Temperature	<6minutes

## X-ON Electronics

Largest Supplier of Electrical and Electronic Components

*Click to view similar products for [ESD Suppressors / TVS Diodes](#) category:*

*Click to view products by [FUXINSEMI](#) manufacturer:*

Other Similar products are found below :

[60KS200C](#) [D18V0L1B2LP-7B](#) [D5V0F4U5P5-7](#) [NTE4902](#) [P4KE27CA](#) [P6KE11CA](#) [P6KE39CA-TP](#) [P6KE8.2A](#) [JANTX1N6053A](#)  
[SA110CA](#) [SA60CA](#) [SA64CA](#) [SMBJ12CATR](#) [SMBJ33CATR](#) [SMBJ8.0A](#) [ESD101-B1-02ELS E6327](#) [ESD105-B1-02EL E6327](#) [ESD112-B1-02EL E6327](#) [ESD119B1W01005E6327XTSA1](#) [ESD5V0L1B02VH6327XTSA1](#) [ESD7451N2T5G](#) [19180-510](#) [CPDT-5V0USP-HF](#)  
[3.0SMCJ33CA-F](#) [3.0SMCJ36A-F](#) [HSPC16701B02TP](#) [JANTX1N6126A](#) [JANTX1N6462](#) [JANTX1N6465](#) [USB50805e3/TR7](#)  
[D3V3Q1B2DLP3-7](#) [D55V0M1B2WS-7](#) [DRTR5V0U4SL-7](#) [SCM1293A-04SO](#) [ESD200-B1-CSP0201 E6327](#) [SM12-7](#) [SM1605E3/TR13](#)  
[SMLJ45CA-TP](#) [CEN955 W/DATA](#) [82350120560](#) [VESD12A1A-HD1-GS08](#) [CPDUR5V0R-HF](#) [CPDQC5V0U-HF](#) [CPDQC5V0USP-HF](#)  
[CPDQC5V0-HF](#) [D1213A-01LP4-7B](#) [ESD101-B1-02EL E6327](#) [824500181](#) [MMAD1108/TR13](#) [5KP100A](#)