

Features

- For surface mounted applications in order to optimize board space.
- Low profile package.
- Excellent clamping capability.
- IEC61000-4-2 ESD 30kV Air, 30kV contact compliance
- Protects one I/O line
- Lead-free parts meet RoHS requirements.
- Compliant to Halogen-free

Applications

- Personal digital assistants (PDA)
- Cellular handsets & Accessories
- Portable devices
- Portable instrumentation
- Handhelds and notebooks
- Digital cameras

Mechanical data

- Epoxy : UL94-V0 rated flame retardant
- Case : Molded plastic, SOD-123
- Terminals : Plated terminals, solderable per MIL-STD-750, Method 2026
- Polarity : Indicated by cathode band
- Mounting Position : Any

Package outline

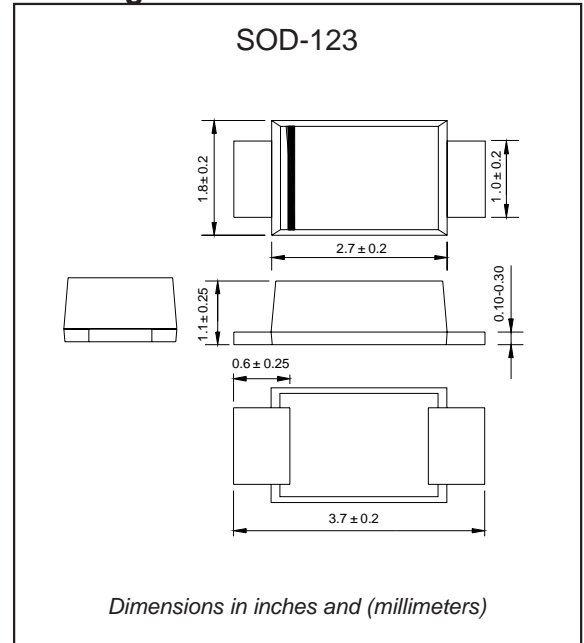

Maximum ratings and Electrical Characteristics (AT $T_A=25^\circ\text{C}$ unless otherwise noted)

PARAMETER	CONDITIONS	Symbol	Value	UNIT
Peak Power Dissipation	Peak Pulse Power Dissipation at $T_A=25^\circ\text{C}$ by $10 \times 1000\mu\text{s}$ (Note 1)	P_{PPM}	200	W
Operating junction temperature range		T_J	-55 to +150	$^\circ\text{C}$
Storage temperature range		T_{STG}	-55 to +150	$^\circ\text{C}$

Note: 1. Non-repetitive current pulse, per Fig. 2 and derated above $T_A=25^\circ\text{C}$ per Fig. 1

Electrical characteristics (at $T_A=25^{\circ}\text{C}$ unless otherwise noted)

Part Number Add C For Bi-Directional (Note 4)	Reverse Standoff Voltage V_{RWM} (V)	Breakdown Voltage V_{BR} @ I_T (Note 5)		Test Current I_T (mA)	Max. Reverse Leakage @ V_{RWM} (Note 6) I_R (μA)	Max. Clamping Voltage @ I_{PP} V_C (V)	Max. Peak Pulse Current I_{PP} (A)	Marking Code	
		Min (V)	Max (V)					BI-	UNI-
SMF5.0(C)A	5.0	6.40	7.25	10	800	9.2	21.7	CAE	AE
SMF6.0(C)A	6.0	6.67	7.37	10	800	10.3	19.4	CAG	AG
SMF6.5(C)A	6.5	7.22	7.98	10	500	11.2	17.9	CAK	AK
SMF7.0(C)A	7.0	7.78	8.60	10	200	12.0	16.7	CAM	AM
SMF7.5(C)A	7.5	8.33	9.21	1.0	100	12.9	15.5	CAP	AP
SMF8.0(C)A	8.0	8.89	9.83	1.0	50	13.6	14.7	CAR	AR
SMF8.5(C)A	8.5	9.44	10.4	1.0	10	14.4	13.9	CAT	AT
SMF9.0(C)A	9.0	10.0	11.1	1.0	5.0	15.4	13.0	CAV	AV
SMF10(C)A	10	11.1	12.3	1.0	5.0	17.0	11.8	CAX	AX
SMF11(C)A	11	12.2	13.5	1.0	5.0	18.2	11.0	CAZ	AZ
SMF12(C)A	12	13.3	14.7	1.0	5.0	19.9	10.1	CBE	BE
SMF13(C)A	13	14.4	15.9	1.0	5.0	21.5	9.3	CBG	BG
SMF14(C)A	14	15.6	17.2	1.0	5.0	23.2	8.6	CBK	BK
SMF15(C)A	15	16.7	18.5	1.0	5.0	24.4	8.2	CBM	BM
SMF16(C)A	16	17.8	19.7	1.0	5.0	26.0	7.7	CBP	BP
SMF17(C)A	17	18.9	20.9	1.0	5.0	27.6	7.2	CBR	BR
SMF18(C)A	18	20.0	22.1	1.0	5.0	29.2	6.8	CBT	BT
SMF20(C)A	20	22.2	24.5	1.0	5.0	32.4	6.2	CBV	BV
SMF22(C)A	22	24.4	26.9	1.0	5.0	35.5	5.6	CBX	BX
SMF24(C)A	24	26.7	29.5	1.0	5.0	38.9	5.1	CBZ	BZ
SMF26(C)A	26	28.9	31.9	1.0	5.0	42.1	4.8	CCE	CE
SMF28(C)A	28	31.1	34.4	1.0	5.0	45.4	4.4	CCG	CG
SMF30(C)A	30	33.3	36.8	1.0	5.0	48.4	4.2	CCK	CK
SMF33(C)A	33	36.7	40.6	1.0	5.0	53.3	3.8	CCM	CM
SMF36(C)A	36	40.0	44.2	1.0	5.0	58.1	3.5	CCP	CP
SMF40(C)A	40	44.4	49.1	1.0	5.0	64.5	3.1	CCR	CR
SMF43(C)A	43	47.8	52.8	1.0	5.0	69.4	2.9	CCT	CT
SMF45(C)A	45	50.0	55.3	1.0	5.0	72.7	2.8	CCV	CV
SMF48(C)A	48	53.3	58.9	1.0	5.0	77.4	2.6	CCX	CX
SMF51(C)A	51	56.7	62.7	1.0	5.0	82.4	2.5	CCZ	CZ
SMF54(C)A	54	60.0	66.3	1.0	5.0	87.1	2.3	CDE	DE
SMF58(C)A	58	64.4	71.2	1.0	5.0	93.6	2.3	CDG	DG
SMF60(C)A	60	66.7	73.7	1.0	5.0	96.8	2.1	CDK	DK
SMF64(C)A	64	71.1	78.6	1.0	5.0	103	2.0	CDM	DM
SMF70(C)A	70	77.8	86.0	1.0	5.0	113	1.8	CDP	DP
SMF75(C)A	75	83.3	92.1	1.0	5.0	121	1.7	CDR	DR
SMF78(C)A	78	86.7	95.8	1.0	5.0	126	1.6	CDT	DT
SMF85(C)A	85	94.4	104	1.0	5.0	137	1.5	CDV	DV
SMF90(C)A	90	100	111	1.0	5.0	146	1.4	CDX	DX
SMF100(C)A	100	111	123	1.0	5.0	162	1.3	CDZ	DZ
SMF110(C)A	110	122	135	1.0	5.0	177	1.2	CEE	EE
SMF120(C)A	120	133	147	1.0	5.0	193	1.1	CEG	EG
SMF130(C)A	130	144	159	1.0	5.0	209	1.0	CEK	EK
SMF150(C)A	150	167	185	1.0	5.0	243	0.8	CEM	EM
SMF160(C)A	160	178	197	1.0	5.0	259	0.8	CEP	EP
SMF170(C)A	170	189	209	1.0	5.0	275	0.8	CER	ER

- Notes: 4. Suffix C denotes Bi-directional device.
5. V_{BR} measured with I_T current pulse = 300 μs
6. For Bi-Directional devices having V_{RWM} of 10V and under, the I_R is doubled.

Rating and characteristic curves

FIG.1 - PULSE DERATING CURVE

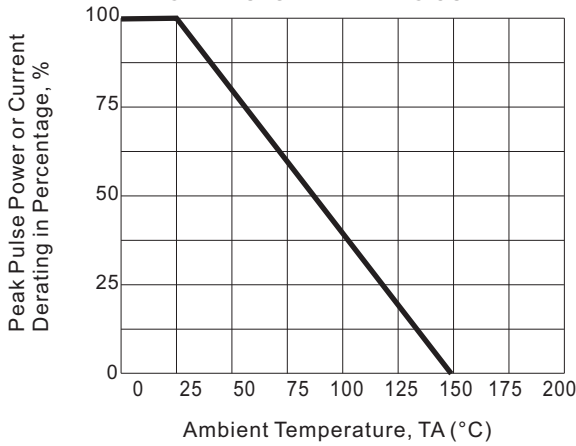

FIG.2 - 10X1000us PULSE WAVEFORM

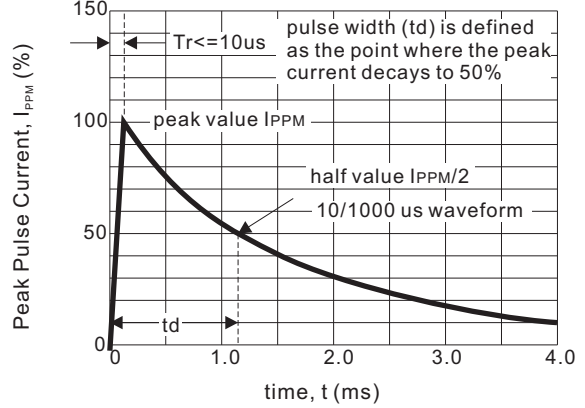

FIG.3 - 8X20us PULSE WAVEFORM

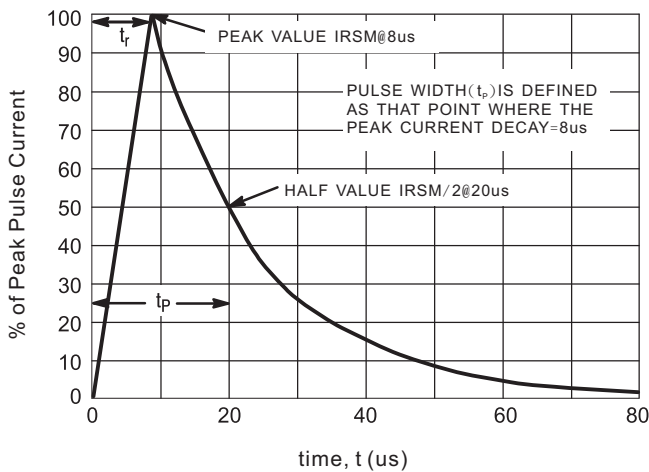

FIG.4 - PEALK PULSE POWER RATING CURVE

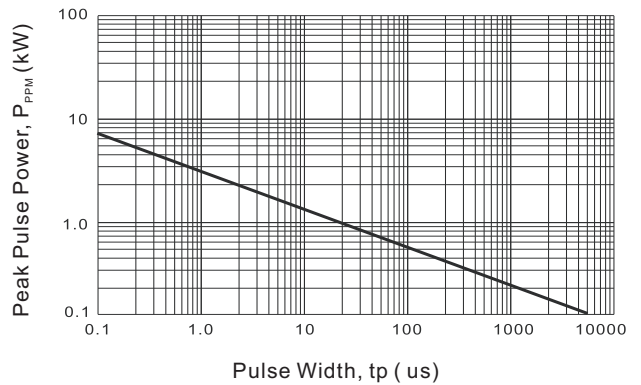
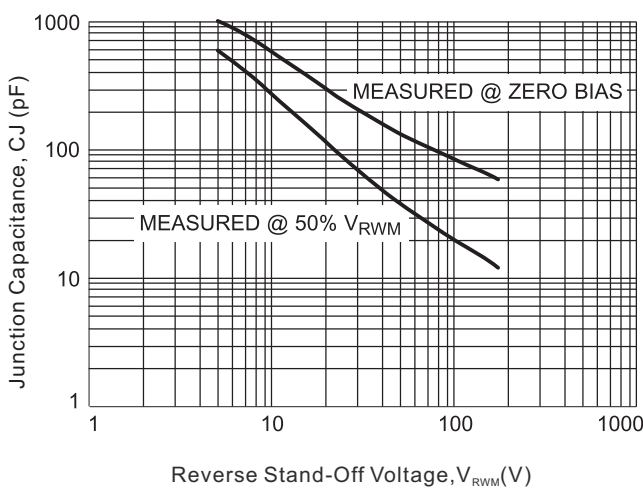





FIG.5 - TYPICAL JUNCTION CAPACITANCE



Pinning information

Pin	Simplified outline	Symbol
Uni-Directional Pin1 cathode Pin2 anode		
Bi-Directional		

Marking

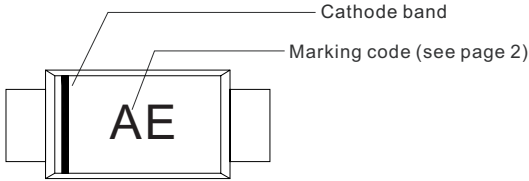
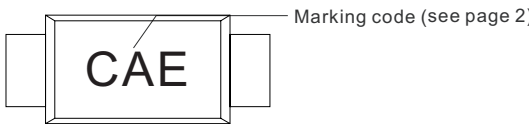
Type number	Example
Uni-Directional	
Bi-Directional	

Suggested solder pad layout

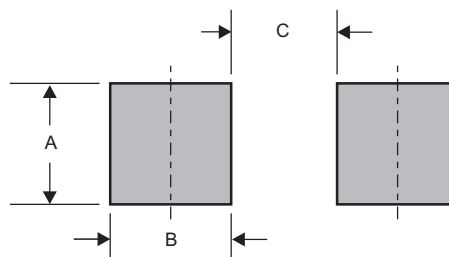

Dimensions in inches and (millimeters)

PACKAGE	A	B	C
SOD-123	0.044 (1.10)	0.040 (1.00)	0.079 (2.00)

Suggested thermal profiles for soldering processes

- 1.Storage environment: Temperature=5°C~40°C Humidity=55%±25%
- 2.Reflow soldering of surface-mount devices

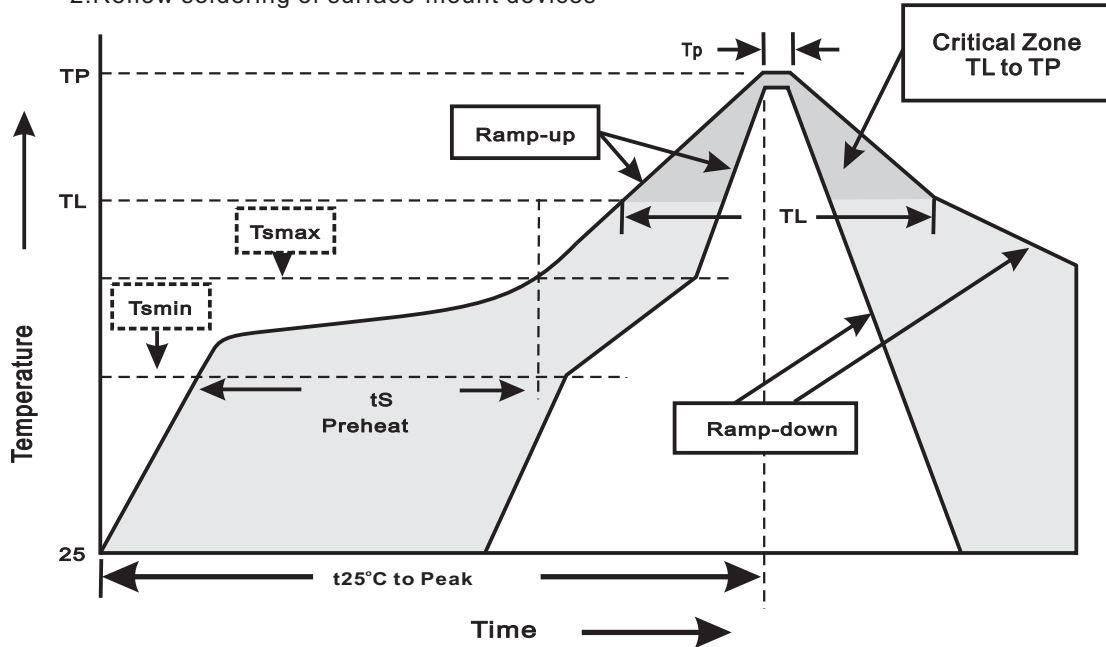

3.Reflow soldering

Profile Feature	Soldering Condition
Average ramp-up rate(TL to TP)	<3°C/sec
Preheat -Temperature Min(Tsmmin) -Temperature Max(Tsmmax) -Time(min to max)(tS)	150°C 200°C 60~120sec
Tsmmax to TL -Ramp-upRate	<3°C/sec
Time maintained above: -Temperature(TL) -Time(tL)	217°C 60~260sec
Peak Temperature(TP)	255°C-0/+5°C
Time within 5°C of actual Peak Temperature(tp)	10~30sec
Ramp-down Rate	<6°C/sec
Time 25°C to Peak Temperature	<6minutes

X-ON Electronics

Largest Supplier of Electrical and Electronic Components

Click to view similar products for [ESD Suppressors / TVS Diodes](#) category:

Click to view products by [FUXINSEMI](#) manufacturer:

Other Similar products are found below :

[60KS200C](#) [D18V0L1B2LP-7B](#) [D5V0F4U5P5-7](#) [NTE4902](#) [P4KE27CA](#) [P6KE11CA](#) [P6KE8.2A](#) [JANTX1N6053A](#) [SA110CA](#) [SA60CA](#)
[SA64CA](#) [SMBJ12CATR](#) [SMBJ33CATR](#) [SMBJ8.0A](#) [ESD105-B1-02EL E6327](#) [ESD112-B1-02EL E6327](#) [ESD5V0L1B02VH6327XTSA1](#)
[ESD7451N2T5G](#) [19180-510](#) [CPDT-5V0USP-HF](#) [3.0SMCJ33CA-F](#) [3.0SMCJ36A-F](#) [HSPC16701B02TP](#) [JANTX1N6126A](#) [JANTX1N6465](#)
[D3V3Q1B2DLP3-7](#) [D55V0M1B2WS-7](#) [DRTR5V0U4SL-7](#) [SCM1293A-04SO](#) [ESD200-B1-CSP0201 E6327](#) [SM12-7](#) [CEN955 W/DATA](#)
[82350120560](#) [VESD12A1A-HD1-GS08](#) [CPDUR5V0R-HF](#) [CPDQC5V0-HF](#) [D1213A-01LP4-7B](#) [ESD101-B1-02EL E6327](#)
[MMAD1108/TR13](#) [5KP100A](#) [5KP15A](#) [5KP18A](#) [5KP48A](#) [5KP90A](#) [5KP90CA](#) [ESD3V3D7-TP](#) [ESDAVLC12-1BV2](#) [15KPA36A-LF](#)
[NTE4900](#) [P4KE56CA](#)