

G529B(BC)-1\$;G529G(BC)-1\$

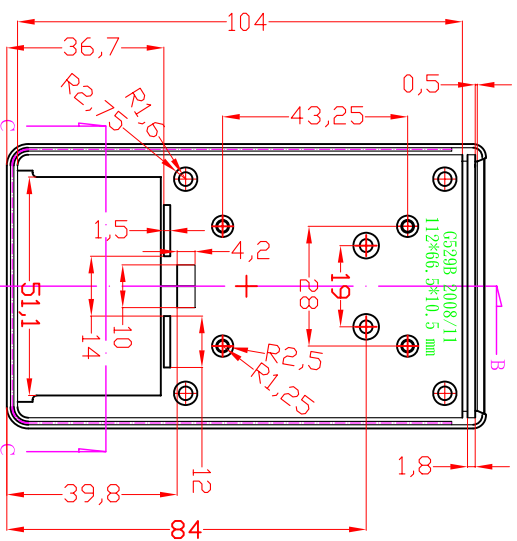

TOP

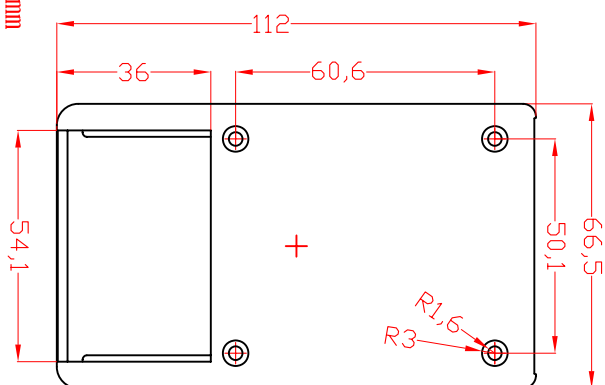
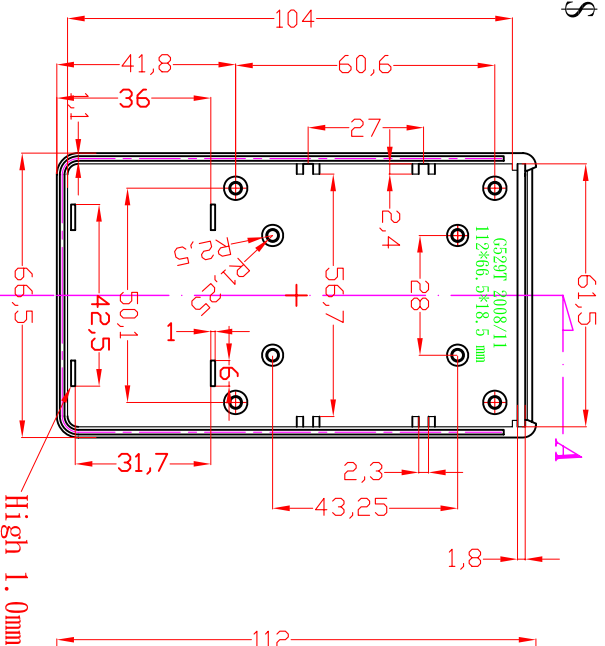
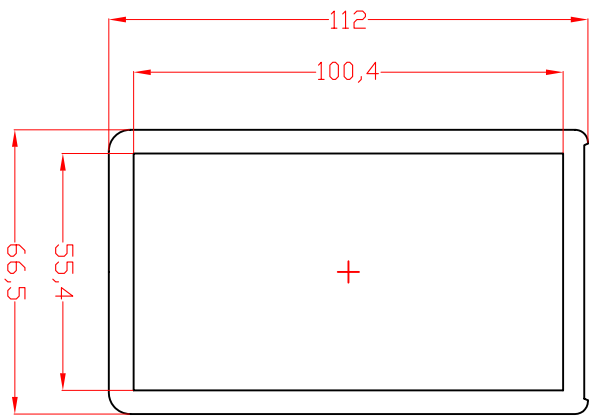
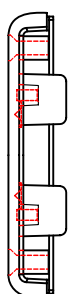
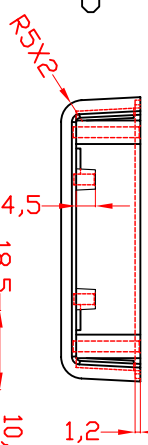

BASE

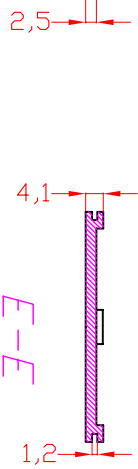
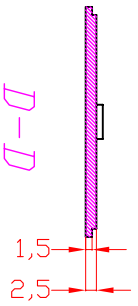
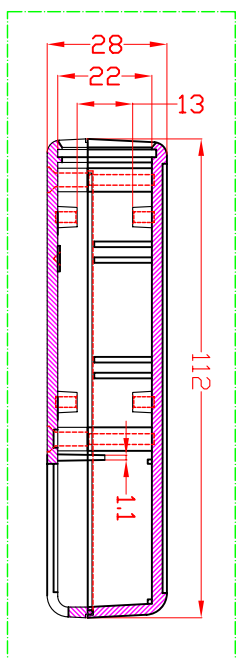
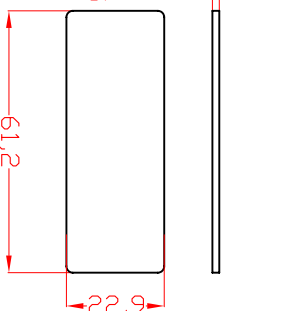
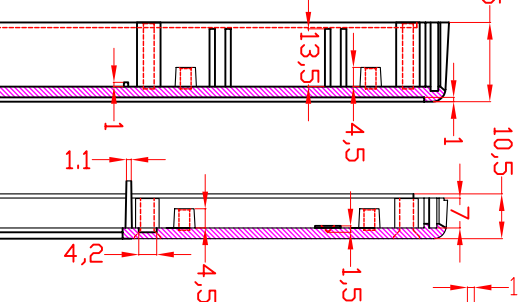
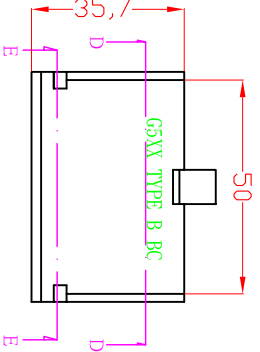
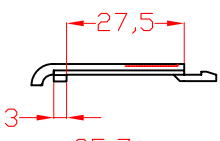
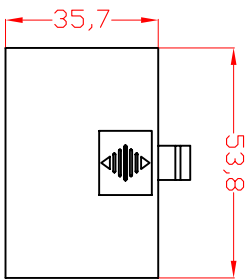
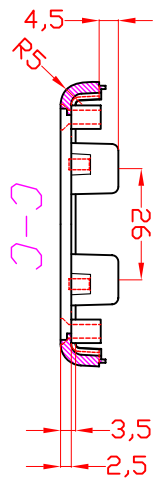

BATTERY-COVER

| ITEM NO       | DESCRIPTION  |
|---------------|--|
| G529R(BC)-1\$ | BLACK(G529T+G529B+PANEL-*\$'+B.C.*1+M3*16 mm BLACK SCREWS *4 |
| G529G(BC)-1\$ | GRAY(G529T+G529B+PANEL-*\$'+B.C.*1+M3*16 mm BLACK SCREWS *4  |

According to ISO 2768-m

| Measuring DIM=L | Tolerance | Measuring DIM=L | Tolerance |
|-----------------|-----------|-----------------|-----------|
| 0.5<L<3.0 mm    | ±0.1 mm   | 300<L<1200 mm   | ±0.3 mm   |
| 3.0<L<6.0 mm    | ±0.1 mm   | 1200<L<4000 mm  | ±0.5 mm   |
| 6.0<L<300 mm    | ±0.2 mm   | 4000<L<10000 mm | ±0.8 mm   |

PANEL- "\$"

宣文實業有限公司  
GAINTA INDUSTRIES LTD.

設計 BY  
DESIGN BY

繪圖 BY  
DRAWN BY

核圖 BY  
CHECK BY

比例 SCALE

日期 DATE

材質 MATE.

圖名 TITLE

圖號 DWG NO.

圖號 REVISID

說明 DESCRIPTION

A

## X-ON Electronics

Largest Supplier of Electrical and Electronic Components

*Click to view similar products for [Enclosures, Boxes, & Cases](#) category:*

*Click to view products by [Gainta](#) manufacturer:*

Other Similar products are found below :

[CR-425 PAINTED](#) [585-R-WH-PK](#) [M-10-PLATED](#) [60221-01](#) [60566-01-000](#) [HPL-9VB BATT DOOR](#) [M-16-LID-PLATED](#) [M18-PLTD](#) [M-21-LID-PLATED](#) [M-21-PLATED](#) [M-23-PLATED](#) [CU-281-MB](#) [6711GSKT](#) [71884-29-028](#) [LH45-100 Black](#) [7200B](#) [72868-510-000](#) [CNS-0000 Black](#) [72883-510-000](#) [CNS-0101 Black](#) [72906-510-000](#) [CNS-0407 Black](#) [73091-510-000](#) [CNM-0000-BLACK Kit](#) [73092-510-000](#) [CNM-0101 Black](#) [73108-510-000](#) [CNL-0303 Black](#) [73395-510-039](#) [CNS-0006 Bone](#) [74257-510-000](#) [CNL-0004](#) [MDC-1183-PLAIN-ALUM](#) [MDC-1183-PTD](#) [MDC-13104-PLAIN-ALUM](#) [MDC-211 - PAINTED IVORY/BEIGE](#) [MDC-321-PTD](#) [MDC-432-PLAIN-ALUM](#) [MDC-973-PTD](#) [76](#) [77153-01-028](#) [FLX6030](#) [83535-01-508](#) [PS-11296-G](#) [PS-11298-B](#) [116-508](#) [120-407](#) [120-412](#) [120-909](#) [120-455](#) [R272-100-000](#) [120-910](#) [R501-001-010](#) [R508-080-000](#) [R508-160-000](#) [R530-120-000](#) [R530-122-000](#) [R530-200-000](#) [R531-160-000](#) [R531-200-000](#) [R582-080-100](#)