

40V 250mA Ultralow-Quiescent-Current LDO

General Description

The GM7350 ultra-low quiescent current regulator features low dropout voltage and low current in the standby mode. With less than 1.5 μ A quiescent current at no load, the GM7350 is ideally suited for standby micro-control-unit systems, especially for always-on applications like E-meters, fire alarms, smoke detectors and other battery operated systems. The GM7350 retains all of the features that are common to low dropout regulators including a low dropout PMOS pass device, short circuit protection, and thermal shutdown.

The GM7350 has a 40-V maximum operating voltage limit, a -40°C to 125°C operating temperature range, and \pm 2% output voltage tolerance over the entire output current, input voltage, and temperature range. The GM7350 is available in a SOT893 through-hole and SOT235, surface mount packages.

Ordering Information

Part Number	Package	Ordering Number
GM7350	SOT893	GM7350
	SOT235	GM7350K

Features

- VIN Range up to 40V
- Output Voltage Tolerances of \pm 2% Over the Temperature Range
- Output Current of 250 mA
- Ultra Low Quiescent Current (IQ = 1.5 μ A)

- Dropout Voltage Typically 1200 mV at IO_{UT} = 250 mA
- Internal Thermal Overload Protection
- Internal Short-Circuit Current Limit
- Ceramic Capacitor Stable

Applications

- E-meters, Water Meters and Gas Meters
- Fire Alarm, Smoke Detector
- Appliances and White Goods

Pin Configuration

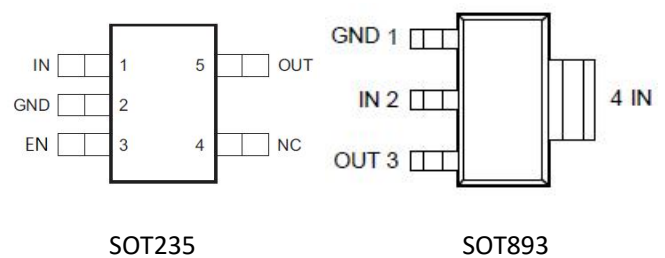

Typical Application Circuit

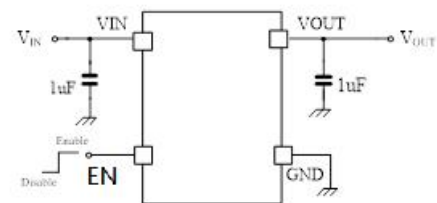
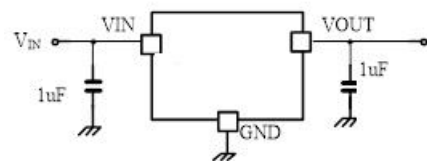

Ceramic Capacitor Stable

Pin Assignment

Pin Name	Pin No. SOT235	Pin No. SOT893	Pin Function
VOUT	5	3	Output Voltage Pin
GND	2	1	Ground
VIN	1	2,4	Input Voltage pin.
EN	3	--	Enable

Function Block Diagram

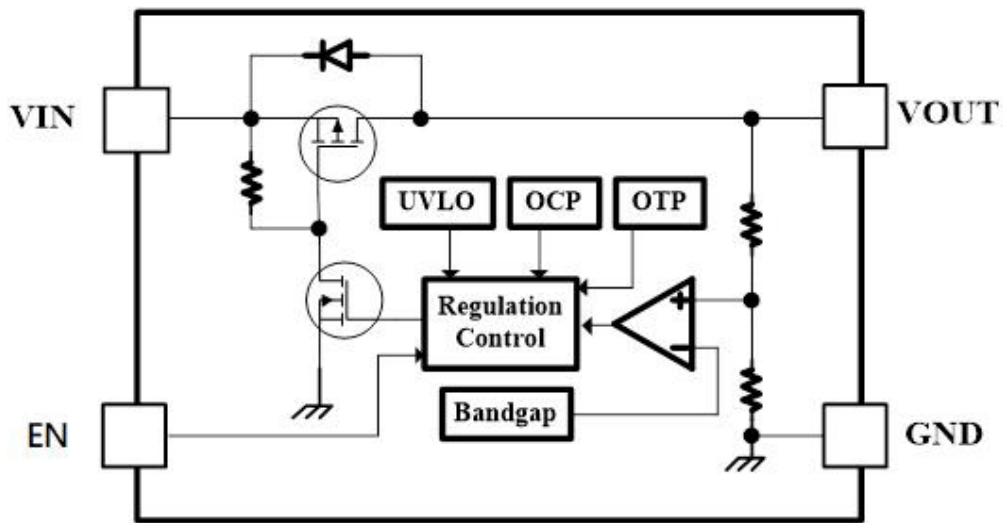

Absolute Maximum Ratings (Note1)

- V_{IN} ----- -0.3V to +45V
- Junction Temperature----- 125°C
- Lead Temperature (Soldering, 10 sec.)----- 300°C
- Storage Temperature ----- -65°C to 150°C

Recommended Operating Conditions

- Input Voltage, V_{IN} ----- +2.7V to +40V
- Junction Temperature ----- -40°C to 125°C

Electrical Characteristics

$V_{IN}=12V$, $I_{OUT}=1mA$, $C_{IN}=C_{OUT}=2.2\mu F$, $T_J=25^\circ C$, unless otherwise specified

Parameter	Symbol	Test Conditions	Min	Typ	Max	Units
Output Voltage	V_{OUT}		-2%	5.0	2%	V
Line Regulation	ΔV_{LINE}	$V_{IN}=V_{OUT} + 1V$ to 40V		2	12	mV
Load Regulation	ΔV_{LOAD}	$I_{OUT}= 1mA$ to 100mA		10	20	mV
		$I_{OUT}= 1mA$ to 250mA		20	30	
Dropout Voltage	V_{DROP}	$I_{OUT}=50mA$		200		mV
		$I_{OUT}=100mA$		400		mV
		$I_{OUT}=180mA$		700		mV
		$I_{OUT}=250mA$		1200		mV
Quiescent Current	I_Q	$T_J= 25^\circ C$		1.5	4.0	μA
Output Current	I_{OUT}		0		250	mA
Current Limit	I_{CL}		270	340		mA
Enable high level	V_{ENHI}		0.9			V
Enable low level	V_{ENLO}				0.4	V
Enable pin pull high current	I_{EN}			0.3		μA
Thermal Shutdown	T_{SD}			140		$^\circ C$
Thermal Shutdown Hysteresis	T_{HY}			20		$^\circ C$

Typical Characteristics

$V_{IN}=12V$, $I_{OUT}=1mA$, $V_{OUT}=3.3V$, $C_{IN}=C_{OUT}=1\mu F$, $T_J=25^\circ C$, unless otherwise specified

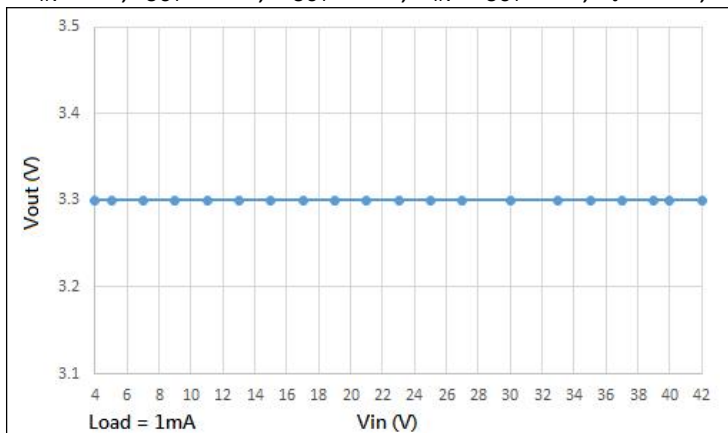

Fig 1 Vout vs Vin

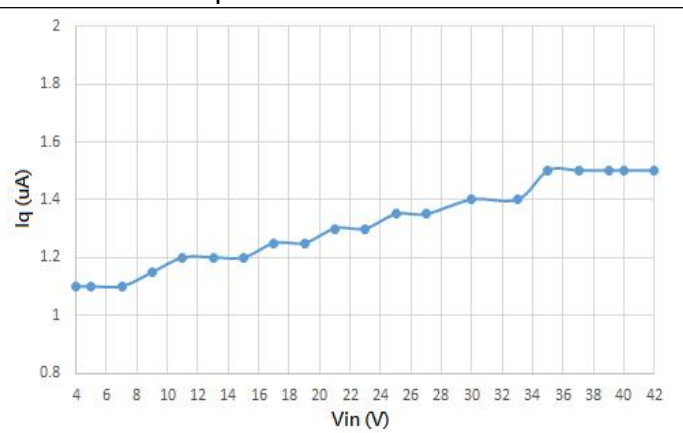

Fig 2 Iq vs Vin

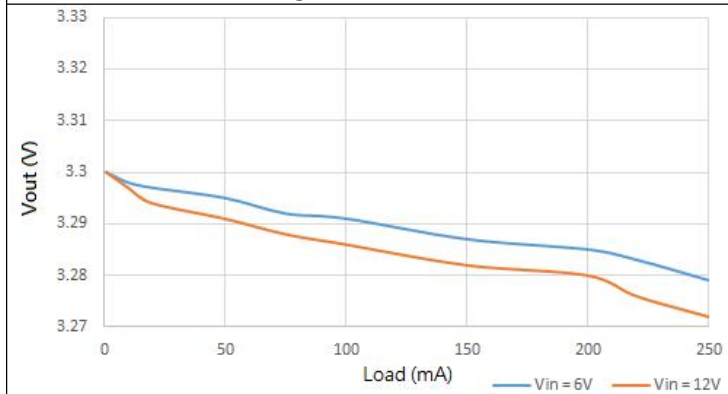

Fig 3 Vout vs Load

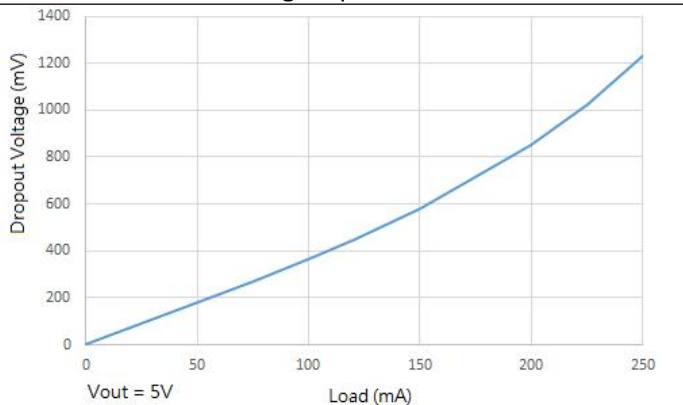

Fig 4 Dropout vs Load



Fig 5 Vout Load Transient (0 to 50mA)

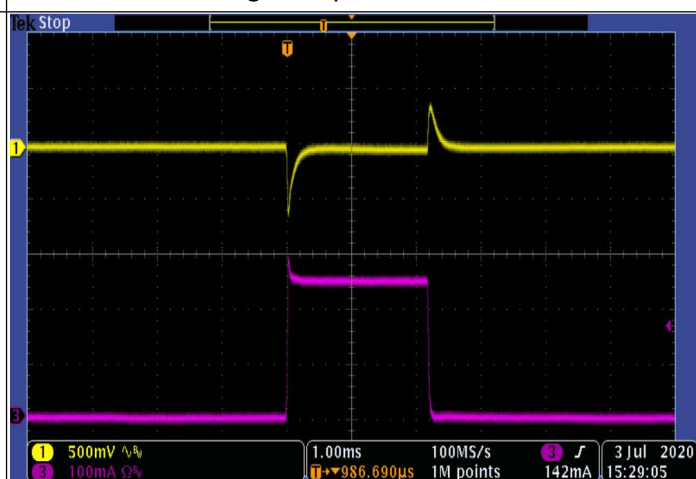

Fig 6 Vout Load Transient (1 to 250mA)

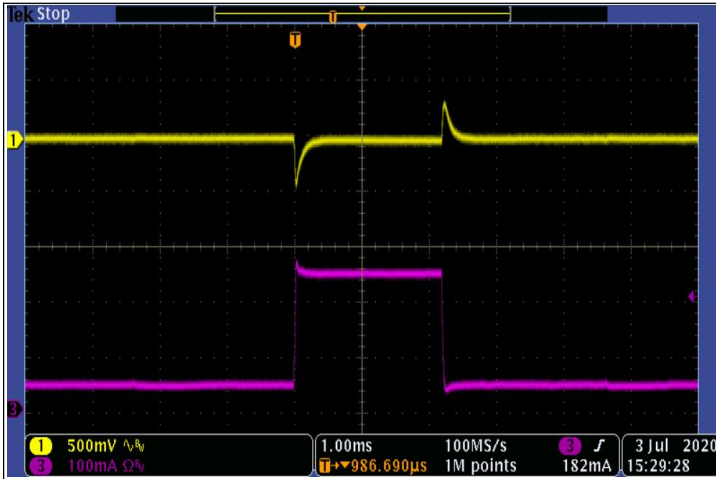

Fig 7 Vout Load Transient (50 to 250mA)

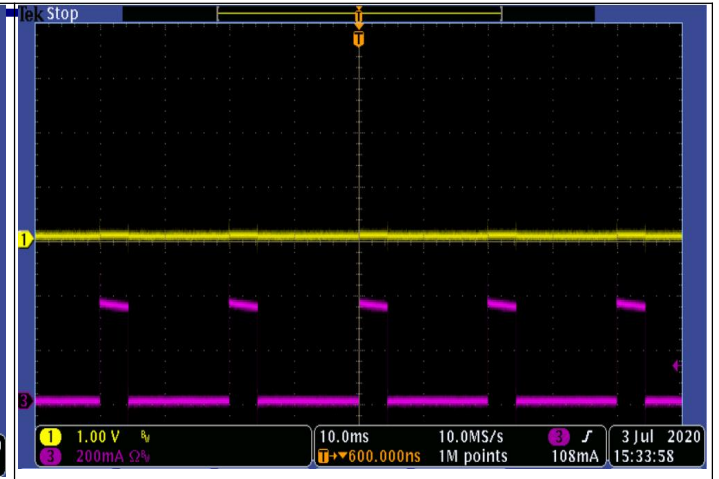

Fig 8 Vout Short to GND

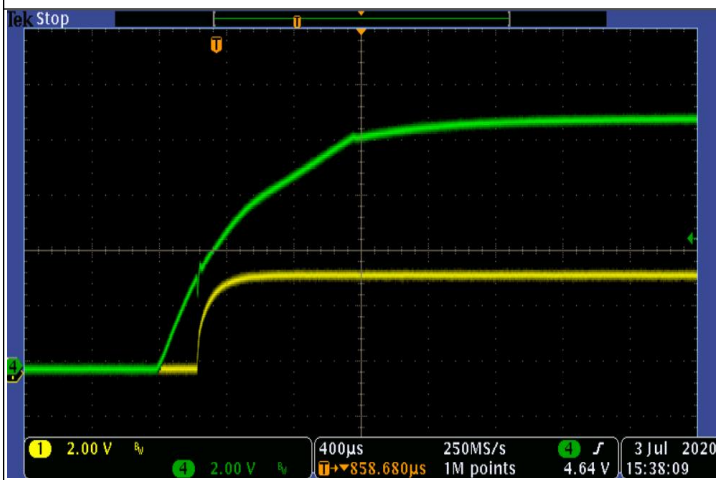
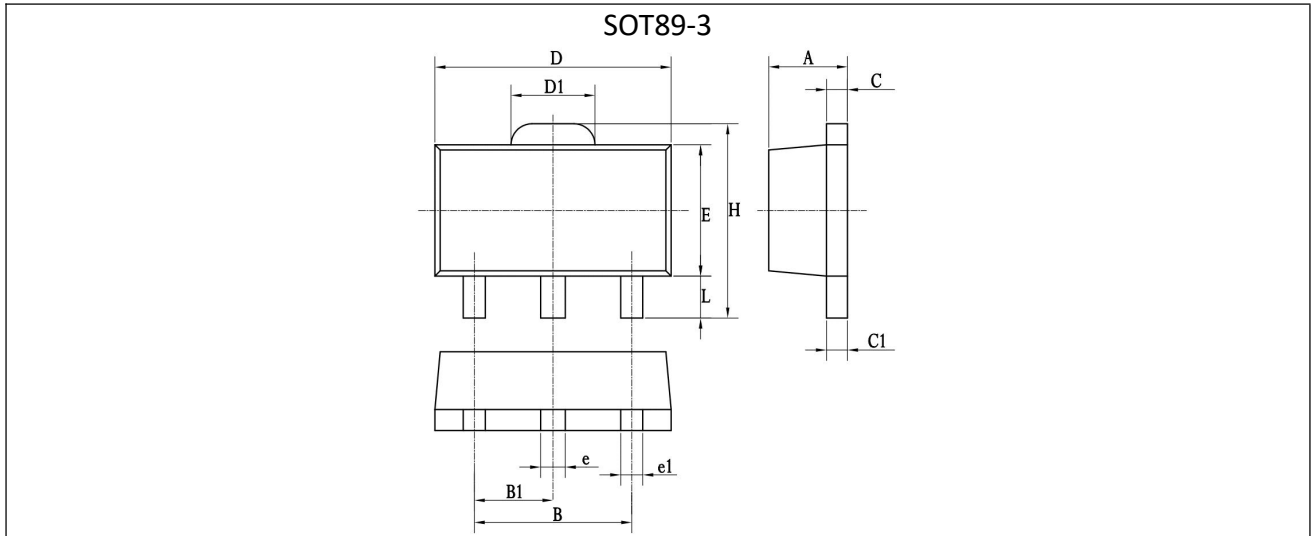
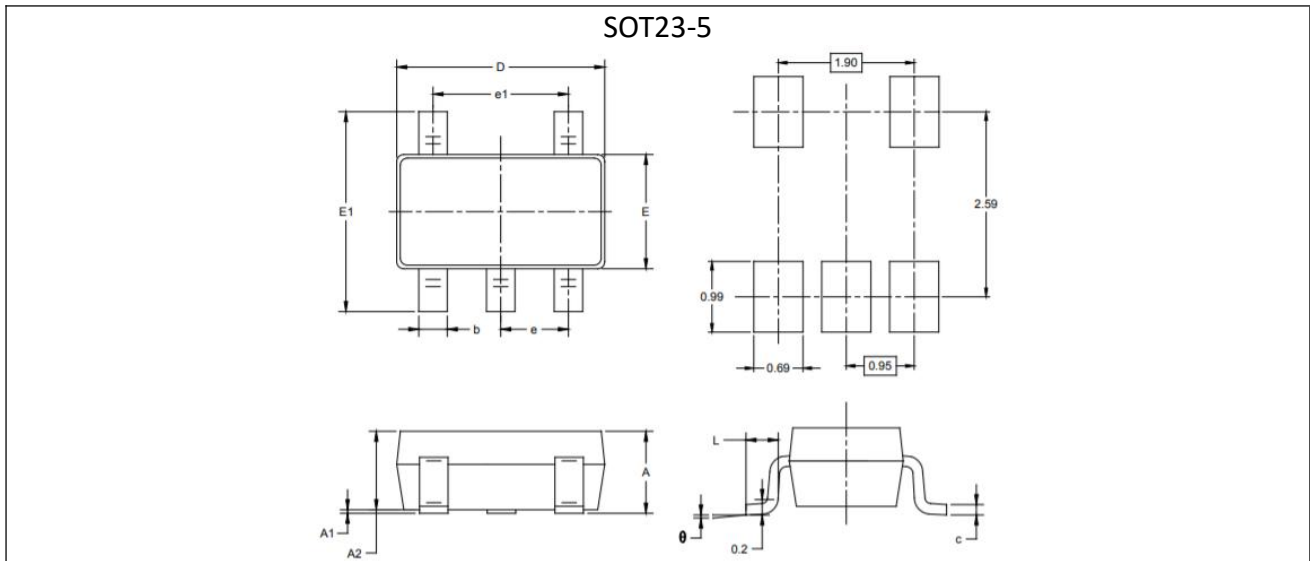

Fig 9 Vin Start up

Package Information



符号	毫米			英寸		
	最小值	典型值	最大值	最小值	典型值	最大值
A	1.4	1.5	1.6	-	-	-
B	2.8	3	3.2	-	-	-
B1	1.4	1.5	1.6	-	-	-
C	0.3	0.4	0.5	-	-	-
C1	0.3	0.4	0.5	-	-	-
D	4.4	4.5	4.6	-	-	-
D1	1.4	1.6	1.8	-	-	-
E	2.4	2.5	2.6	-	-	-
e	0.37	0.47	0.57	-	-	-
e1	0.22	0.42	0.62	-	-	-
H	-	-	4.25	-	-	-
L	0.8	-	-	-	-	-



符号	毫米			英寸		
	最小值	典型值	最大值	最小值	典型值	最大值
A	1.05	1.15	1.25	-	-	-
A1	0.0	0.05	0.1	-	-	-
A2	1.05	1.1	1.15	-	-	-
b	0.3	0.4	0.5	-	-	-
c	0.1	0.15	0.2	-	-	-
D	2.82	2.92	3.02	-	-	-
E	1.5	1.6	1.7	-	-	-
E1	2.65	2.8	2.95	-	-	-
e		0.95		-	-	-
e1		1.9		-	-	-
L	0.3	-	0.6	-	-	-
θ	0°	-	8°	-	-	-

X-ON Electronics

Largest Supplier of Electrical and Electronic Components

Click to view similar products for [Linear Voltage Regulators](#) category:

Click to view products by [GATEMODE](#) manufacturer:

Other Similar products are found below :

[LV5684PVD-XH](#) [MCDTSA6-2R](#) [L7815ACV-DG](#) [LV56801P-E](#) [UA7805CKC](#) [714954EB](#) [ZMR500QFTA](#) [BA033LBSG2-TR](#)
[NCV78M05ABDTRKG](#) [LV5680P-E](#) [L79M05T-E](#) [L78LR05D-MA-E](#) [NCV317MBTG](#) [NTE7227](#) [MP2018GZD-33-P](#) [MP2018GZD-5-P](#)
[LV5680NPVC-XH](#) [ZTS6538SE](#) [UA78L09CLP](#) [UA78L09CLPR](#) [CAT6221-PPTD-GT3](#) [MC78M09CDTRK](#) [NCV51190MNTAG](#)
[BL1118CS8TR1833](#) [BL8077CKETR33](#) [BL9153-33CC3TR](#) [BL9161G-28BADRN](#) [BRCO7530MMC](#) [CJ7815B-TFN-ARG](#) [LM317C](#)
[GM7333K](#) [GM7350K](#) [XC6206P332MR](#) [HT7533](#) [LM7912S/TR](#) [LT1764S/TR](#) [LM7805T](#) [LM338T](#) [LM1117IMP-3.3/TR](#) [HT1117AM-3.3](#)
[HT7550S](#) [AMS1117-3.3](#) [HT7150S](#) [78L12](#) [HT7550](#) [HT7533-1](#) [HXY6206I-2.5](#) [HT7133](#) [HT7533S](#) [662K](#)