

Recommended PCB Layout
General Tolerance: ± 0.05
Solder Area

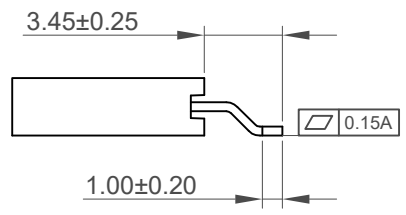
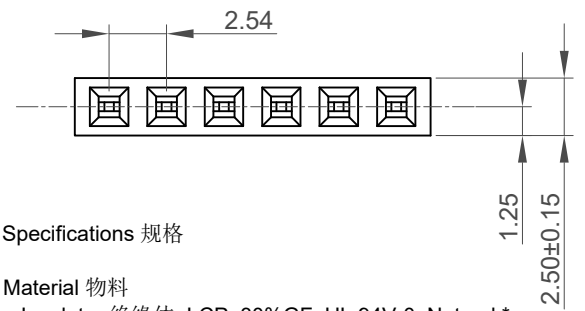
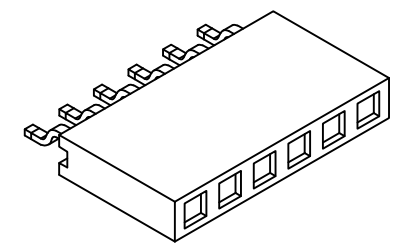

Number of Contacts	Dimensions	
	A	B
2	5.63	2.54
3	8.17	5.08
4	10.71	7.62
5	13.25	10.16
6	15.79	12.70

Specifications 规格

Material 物料

Insulator 绝缘体: LCP, 30%GF, UL 94V-0, Natural *
Contact 接触: Copper Alloy

Plating 电镀

Underplating 底层电镀: 50 μ "-100 μ " Nickel all over
Contact Area 接触部分: See ordering grid

Electrical 电气

Current Rating 电流额定值: 3A per pin
Contact Resistance 接触电阻值: 20 m Ω max.
Insulating Resistance 绝缘电阻值: 1000 M Ω min.
Dielectric Withstand Voltage 耐电压: 500V AC

Mechanical & Environmental 机械 & 环境

Operating Temperature 工作温度: -40°C to +105°C
Mating Force 插入力: 35N (3.57Kgf) max.
Unmating Force 拔出力: 10N (1.02Kgf) min.
Durability 耐久性: 1,500 Cycles

Soldering Process 可焊性:

IR Reflow 回流焊: 260°C for 10 secs
Manual Solder 人工焊接: 350°C for 3-5 secs

Mates with 配套之公头:

BG301 for perfect horizontal mating.
(max. mating pin length 5.4mm)

*Standard black insulator version of BG300 is BG230

Ordering Grid

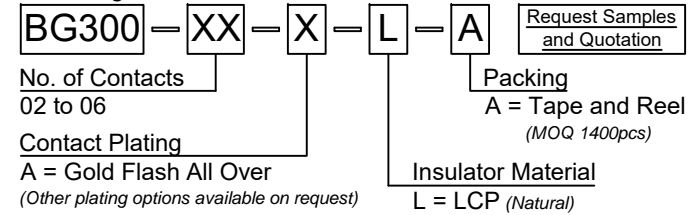

Part Number		Product Description	
BG300		2.54mm Pitch Socket	
Drawing Date		Single Row, Surface Mount, Horizontal, Natural LCP	
7th December 2011			
By	CC	Tolerances (Except as Noted)	Units:
Detail	BG300	Length	Metric (mm)
Revision	C PCN	Angle	
Date	C2	X.X \pm 0.30	
	21/03/17	X.XX \pm 0.25	



This drawing is confidential and copyright of Global Connector Technology, Ltd (GCT). This drawing must not be copied or disclosed without written consent. E & OE



Not to Scale	Drawn By CM	Sheet No. 1/2
--------------	----------------	------------------

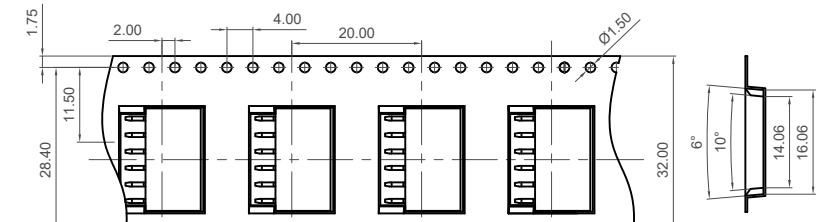
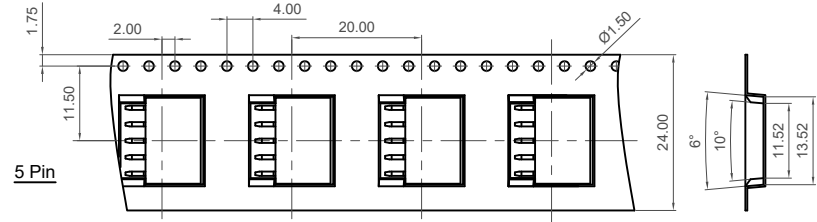
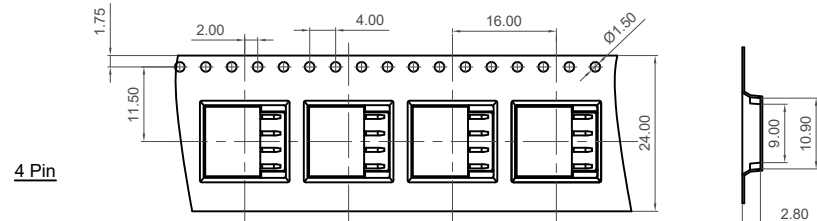
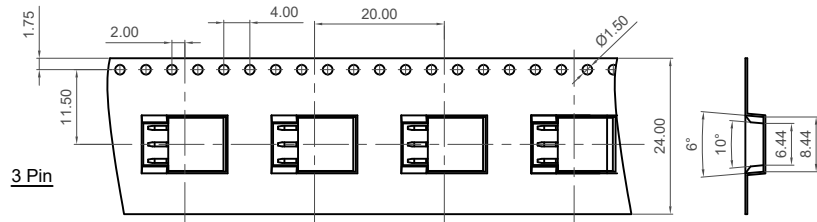
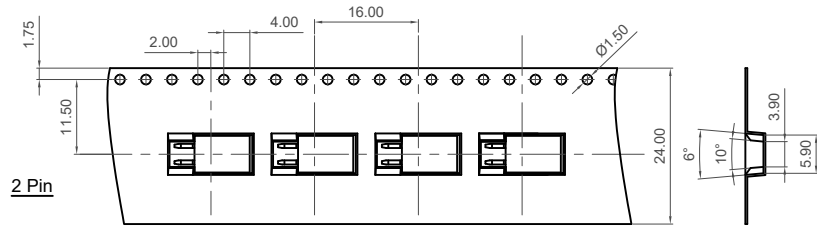

No. of Contacts	Units/ Reel	Reels/ Carton	Units/ Carton	Total Carrier Tape Length/Reel
2,3,4,5	1,400 pcs	10	14,000	23.1 m
6	1,400 pcs	8	11,200	23.1 m

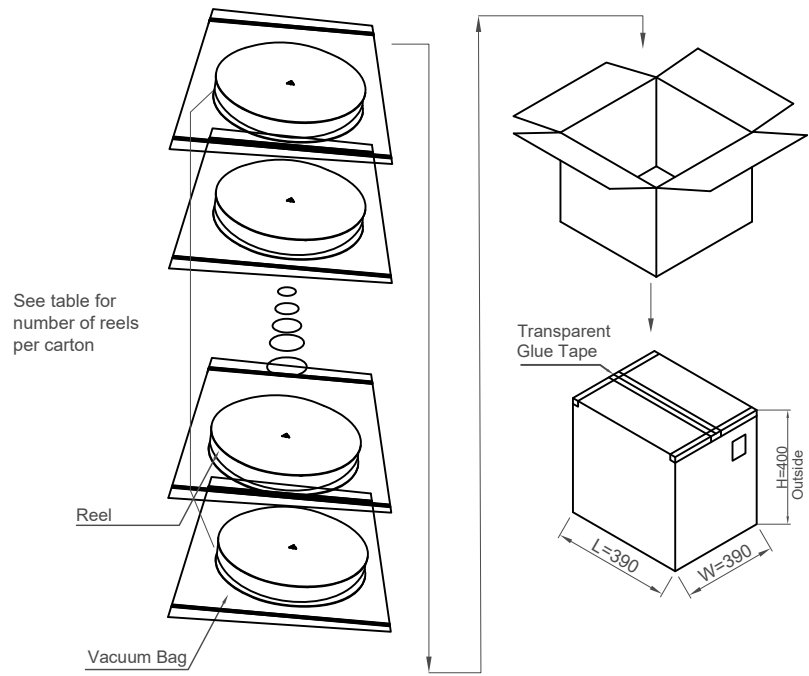
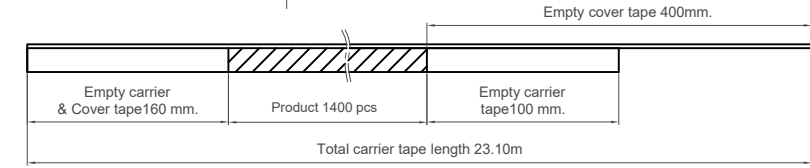
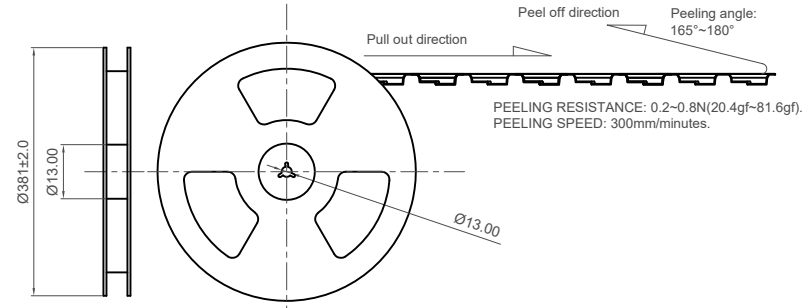

Part Number		Product Description	
BG300		2.54mm Pitch Socket	
Drawing Date		Single Row, Surface Mount, Horizontal, Natural LCP	
7th December 2011			
By	CC	Tolerances (Except as Noted)	Units:
Detail	BG300 C PCN	Length	Metric (mm)
Revision	C2	Angle	
Date	21/03/17		



This drawing is confidential and copyright of Global Connector Technology, Ltd (GCT). This drawing must not be copied or disclosed without written consent. E & OE



Not to Scale	Drawn By CM	Sheet No. 2/2
--------------	-------------	---------------

X-ON Electronics

Largest Supplier of Electrical and Electronic Components

Click to view similar products for [Board to Board & Mezzanine Connectors](#) category:

Click to view products by [GCT](#) manufacturer:

Other Similar products are found below :

[589158040000018](#) [MDF7C-18P-2.54DSA\(55\)](#) [FCN-230C068-11](#) [FCN-268F012-G/BD](#) [FCN-268F036-G/BD](#) [FCN-268M012-G/0D](#) [FCN-268M024-G/1D](#) [FCN-723J004/1](#) [MIS-048-01-F-D-DP-K](#) [832-10-034-10-001000](#) [FX4C-80S-1.27DSA](#) [FCN-214Q030-G/0](#) [FCN-234P048-G/0](#) [FCN-235D050-G/C](#) [210-93-314-41-105000](#) [2-22603-0](#) [MDF7-40DP-2.54DSA\(55\)](#) [AXG720047](#) [5031084030](#) [MIT-114-03-F-D-K](#) [55323-1519](#) [DF33-2P-3.3DSA\(24\)](#) [YFT-20-05-H-03-SB-K](#) [503308-3040](#) [026-6203-PDB](#) [027-6203-PDB](#) [069159702701000](#) [10123981-102LF](#) [101A10019X](#) [55650-0588-C](#) [68684-306](#) [75140-7012](#) [589159005003045](#) [063209](#) [194261-1](#) [FCN-268F024-G0D](#) [10124054-515LF](#) [68685-603](#) [8-1616154-3](#) [MIS-019-01-F-D](#) [589159005002045](#) [541371078](#) [IL-WX-10PB-HF-B-E1000E](#) [FCN-268M024-G/3D](#) [20021832-06016C1LF](#) [KX15-20KLDL-E1000E](#) [MDF7-16DP-2.54DSA\(55\)](#) [AXE810124](#) [FCN-214J100-G/0](#) [FCN-230C068-E/S](#)