

## Silicon Standard Recovery Diode

$V_{RRM} = 50\text{ V} - 300\text{ V}$

$I_F = 15\text{ A}$

### Features

- High Surge Capability
- Types from 50 V to 300 V  $V_{RRM}$
- Not ESD Sensitive

### Note:

1. Standard polarity: Stud is cathode.
2. Reverse polarity (R): Stud is anode.
3. Stud is base.

DO-5 Package

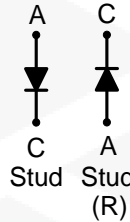

### Maximum ratings, at $T_j = 25\text{ }^\circ\text{C}$ , unless otherwise specified

Parameter	Symbol	Conditions	1N3208 (R)	1N3209 (R)	1N3210 (R)	1N3211 (R)	Unit
Repetitive peak reverse voltage	$V_{RRM}$		50	100	200	300	V
RMS reverse voltage	$V_{RMS}$		35	70	140	210	V
DC blocking voltage	$V_{DC}$		50	100	200	300	V
Continuous forward current	$I_F$	$T_C \leq 150\text{ }^\circ\text{C}$	15	15	15	15	A
Surge non-repetitive forward current, Half Sine Wave	$I_{F,SM}$	$T_C = 25\text{ }^\circ\text{C}$ , $t_p = 8.3\text{ ms}$	297	297	297	297	A
Operating temperature	$T_j$		-55 to 150	-55 to 150	-55 to 150	-55 to 150	$^\circ\text{C}$
Storage temperature	$T_{stg}$		-55 to 150	-55 to 150	-55 to 150	-55 to 150	$^\circ\text{C}$

### Electrical characteristics, at $T_j = 25\text{ }^\circ\text{C}$ , unless otherwise specified

Parameter	Symbol	Conditions	1N3208 (R)	1N3209 (R)	1N3210 (R)	1N3211 (R)	Unit
Diode forward voltage	$V_F$	$I_F = 15\text{ A}$ , $T_j = 25\text{ }^\circ\text{C}$	1.5	1.5	1.5	1.5	V
Reverse current	$I_R$	$V_R = 50\text{ V}$ , $T_j = 25\text{ }^\circ\text{C}$	10	10	10	10	$\mu\text{A}$
		$V_R = 50\text{ V}$ , $T_j = 150\text{ }^\circ\text{C}$	10	10	10	10	mA

### Thermal characteristics

Thermal resistance, junction - case	$R_{thJC}$		0.65	0.65	0.65	0.65	$^\circ\text{C/W}$
-------------------------------------	------------	--	------	------	------	------	--------------------

Figure .1-Typical Forward Characteristics

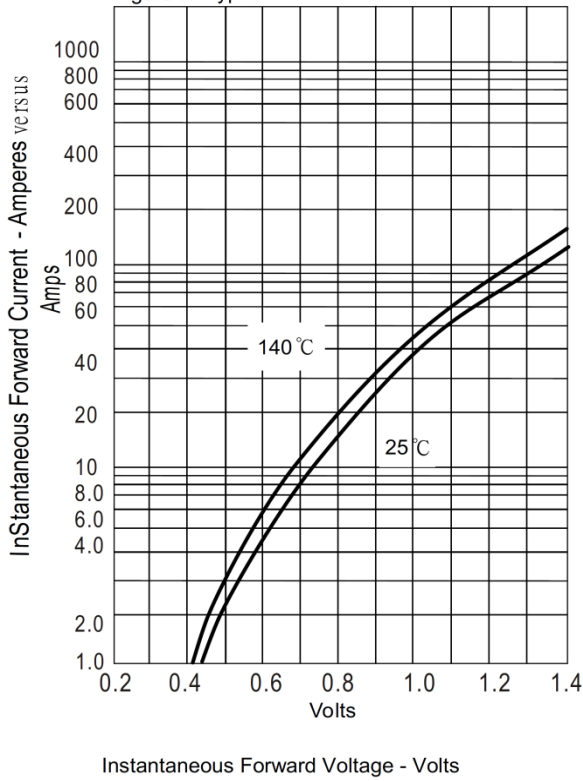

Figure .2-Forward Derating Curve

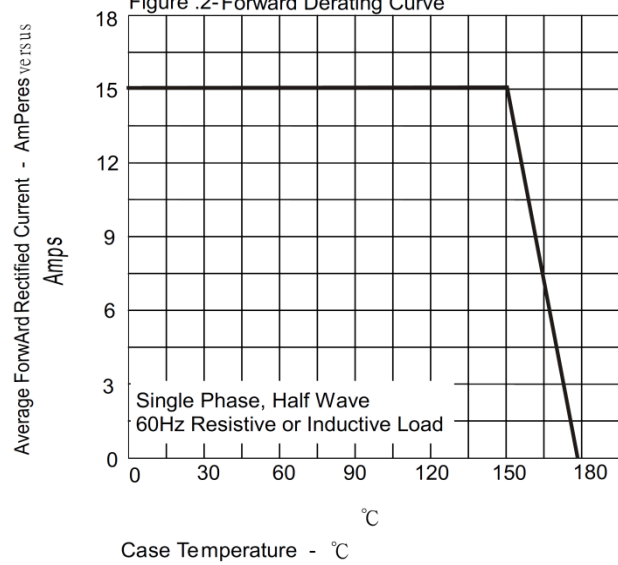

Figure .4-Typical Reverse Characteristics

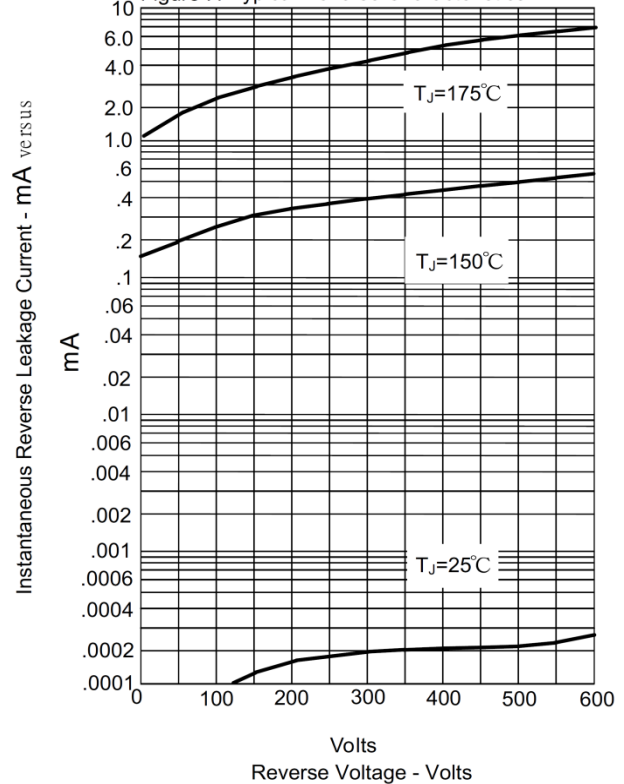
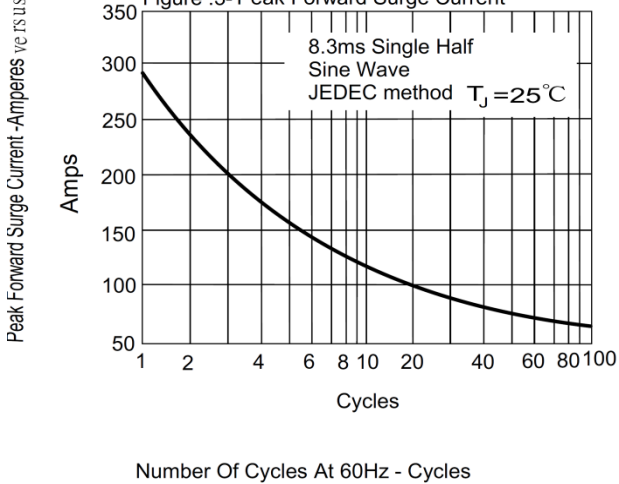
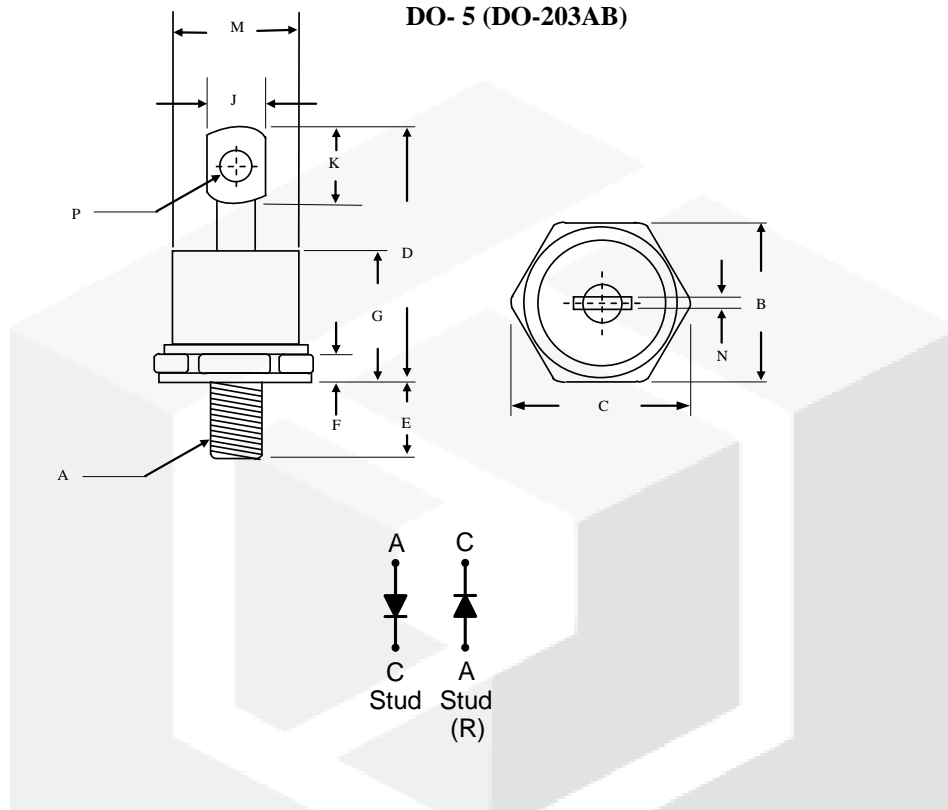

Figure .3-Peak Forward Surge Current



**Package dimensions and terminal configuration**

Product is marked with part number and terminal configuration.



	Inches		Millimeters	
	Min	Max	Min	Max
A	1/4 -28 UNF			
B	0.669	0.687	17.19	17.44
C	-----	0.794	-----	20.16
D	-----	1.020	-----	25.91
E	0.422	0.453	10.72	11.50
F	0.115	0.200	2.93	5.08
G	-----	0.460	-----	11.68
J	-----	0.280	-----	7.00
K	0.236	-----	6.00	-----
M	-----	0.589	-----	14.96
N	-----	0.063	-----	1.60
P	0.140	0.175	3.56	4.45

## X-ON Electronics

Largest Supplier of Electrical and Electronic Components

*Click to view similar products for [Rectifiers](#) category:*

*Click to view products by [GeneSiC Semiconductor](#) manufacturer:*

Other Similar products are found below :

[70HFR40](#) [RL252-TP](#) [150KR30A](#) [1N5397](#) [SCF5000](#) [1N4002G](#) [1N4005-TR](#) [JANS1N6640US](#) [481235F](#) [RRE02VS6SGTR](#) [067907F](#) [MS306](#)  
[70HF40](#) [T85HFL60S02](#) [VS-88-4031](#) [VS-66-9903](#) [US2JFL-TP](#) [A1N5404G-G](#) [ACGRA4007-HF](#) [ACGRB207-HF](#) [CLH03\(TE16L,Q\)](#)  
[ACGRC307-HF](#) [ACEFC304-HF](#) [85HFR60](#) [40HFR60](#) [VS-88-7272PBF](#) [70HF120](#) [85HFR80](#) [D126A45C](#) [SCF7500](#) [D251N08B](#) [SCHJ22.5K](#)  
[SM100](#) [SCPA2](#) [SCH10000](#) [SDHD5K](#) [VS-12FL100S10](#) [ACGRA4001-HF](#) [D1821SH45T PR](#) [D1251S45T](#) [SKN300/16](#) [SKN 5/08](#) [TSD3G](#)  
[SET130312](#) [MSE07PBHM3/89A](#) [UES1106](#) [NTE6010](#) [JANTX1N5196](#) [SCHS15000](#) [BYV32-200M](#)