

Single Phase Glass Passivated Silicon Bridge Rectifier

$V_{RRM} = 600\text{ V} - 1000\text{ V}$
 $I_O = 3\text{ A}$

Features

- Low forward voltage
- High surge overload rating
- Ideal for printed circuit boards
- High temperature soldering: 260°C/ 10 s
- Types from 600 V up to 1000 V V_{RRM}
- Not ESD Sensitive

Applications

- Switching power supply
- Home appliances, office devices
- Industrial auto-equipments

BR-3 Package

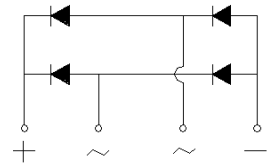

Maximum ratings at $T_A = 25\text{ }^\circ\text{C}$, unless otherwise specified

Parameter	Symbol	Conditions	BR36	BR38	BR310	Unit
Repetitive peak reverse voltage	V_{RRM}		600	800	1000	V
RMS reverse voltage	V_{RMS}		420	560	700	V
DC blocking voltage	V_{DC}		600	800	1000	V
Operating temperature	T_j		-40 to 125	-40 to 125	-40 to 125	$^\circ\text{C}$
Storage temperature	T_{stg}		-40 to 150	-40 to 150	-40 to 150	$^\circ\text{C}$

Electrical characteristics at $T_A = 25\text{ }^\circ\text{C}$, unless otherwise specified

Single phase, half sine wave, 50 Hz, resistive load

For capacitive load derate current by 20%

Parameter	Symbol	Conditions	BR36	BR38	BR310	Unit
Maximum forward rectified current	I_O	$T_C = 40\text{ }^\circ\text{C}$	3	3	3	A
Peak forward surge current	I_{FSM}	$t_p = 8.3\text{ ms}$	60	60	60	A
Maximum forward voltage drop	V_F	$I_F = 1.5\text{ A}$	1.05	1.05	1.05	V
Maximum reverse current at rated DC blocking voltage	I_R	$T_A = 25\text{ }^\circ\text{C}$	10	10	10	μA
		$T_A = 125\text{ }^\circ\text{C}$	500	500	500	
Rating for fusing	I^2t	$1\text{ ms} < t_p < 10\text{ ms}, T_j = 25\text{ }^\circ\text{C}$	15	15	15	A^2s
Thermal resistance	$R_{\theta JA}$		18	18	18	$^\circ\text{C/W}$
Mounting Torque	M		2.0 (1.0 N.m is recommended)			N.m

Fig.1: Current Derating Curve

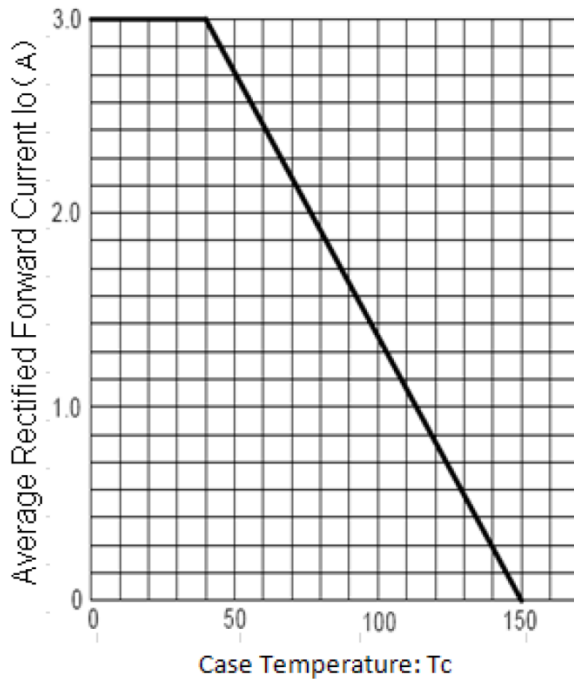

Fig.2: Typical Reverse Characteristics

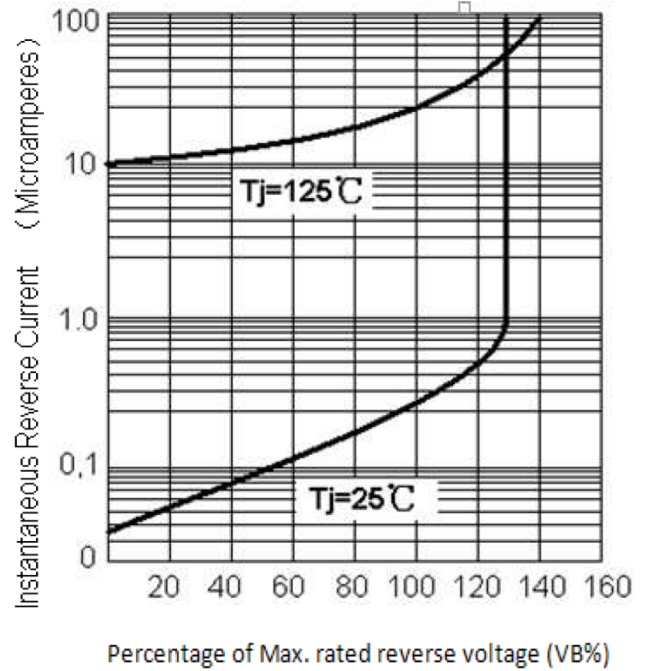

Fig.3: Max. Surge Current

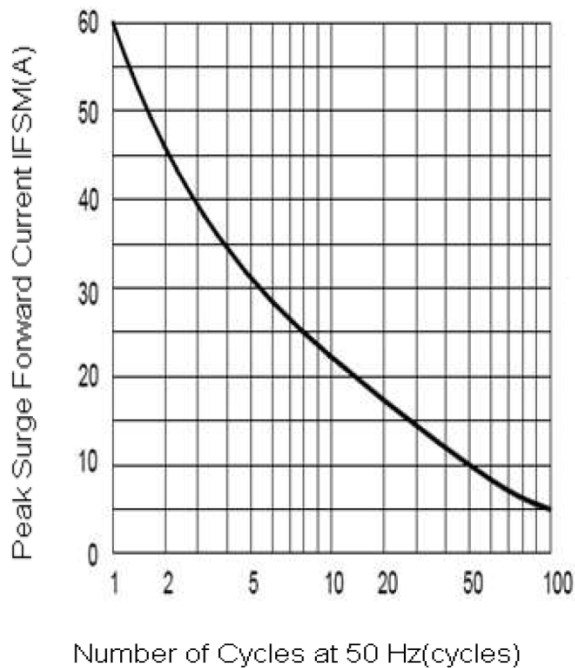
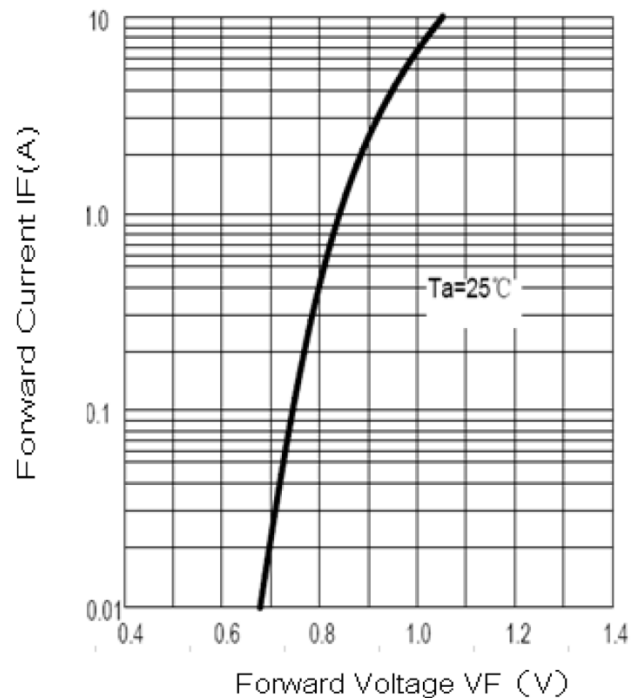

Fig.4: Rated Forward Features



Package dimensions and terminal configuration

Product is marked with part number and terminal configuration.

BR-3

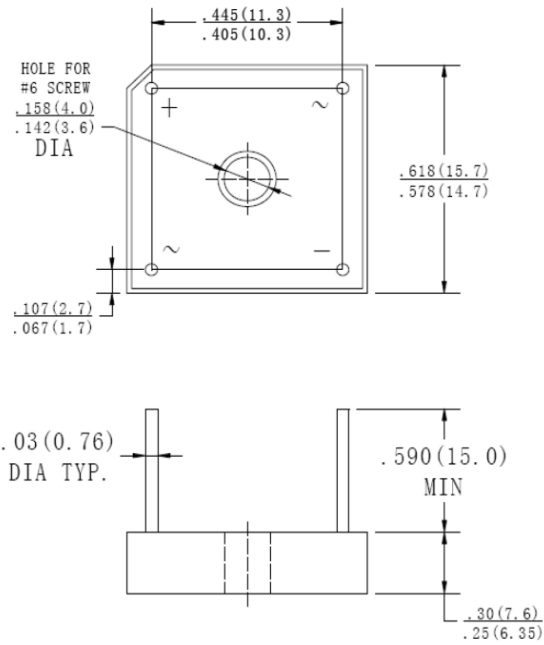

Dimensions in inches and (millimeters)

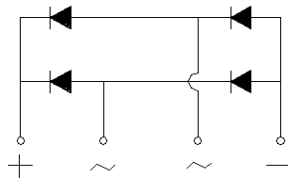

X-ON Electronics

Largest Supplier of Electrical and Electronic Components

Click to view similar products for [Bridge Rectifiers](#) category:

Click to view products by [GeneSiC Semiconductor](#) manufacturer:

Other Similar products are found below :

[MB252](#) [MB356G](#) [MB358G](#) [MP358-BP](#) [GBJ1504-BP](#) [GBU10B-BP](#) [GBU15J-BP](#) [GBU15K-BP](#) [GBU4A-BP](#) [GBU4D-BP](#) [GBU6B-E3/45](#)
[GSIB680-E3/45](#) [DB101-BP](#) [DF01](#) [DF10SA-E345](#) [BU1508-E3/45](#) [KBPC50-10S](#) [RS405GL-BP](#) [G5SBA60-E3/51](#) [GBJ1502-BP](#) [GBU10J-BP](#)
[GBU4J-BP](#) [GBU6M](#) [GBU8D-BP](#) [GBU8J-BP](#) [GSIB1520-E3/45](#) [TB102M](#) [MB1510](#) [MB6M-G](#) [MB86](#) [TL401G](#) [MDA920A2](#) [TU602](#) [TU810](#)
[MP501W-BP](#) [MP502-BP](#) [BR1005-BP](#) [BR101-BP](#) [BR84DTP204](#) [BU1010A-E3/51](#) [BU2006-E3/45](#) [BU2008-E3/51](#) [KBPC25-02](#) [VS-](#)
[60MT120KPBF](#) [DB105-BP](#) [DF1510S](#) [VS-40MT160PAPBF](#) [GBU4G-BP](#) [GBJ2506-BP](#) [GBU6B-E3/51](#)