

# G3R40MT12K

## 1200 V 40 mΩ SiC MOSFET



Silicon Carbide MOSFET  
N-Channel Enhancement Mode

$V_{DS}$	=	1200 V
$R_{DS(ON)(Typ.)}$	=	40 mΩ
$I_D (T_C = 100^\circ C)$	=	50 A

### Features

- G3R™ Technology - +15 V / -5 V Gate Drive
- Superior  $Q_G \times R_{DS(ON)}$  Figure of Merit
- Low Capacitances and Low Gate Charge
- Normally-Off Stable Operation up to 175°C
- Fast and Reliable Body Diode
- High Avalanche and Short Circuit Ruggedness
- Low Conduction Losses at High Temperatures
- Optimized Package with Separate Driver Source Pin

### Package

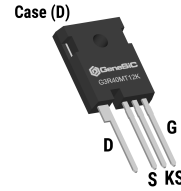

TO-247-4

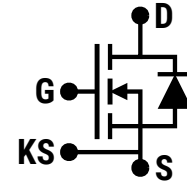

D = Drain  
G = Gate  
S = Source  
KS = Kelvin Source



### Advantages

- Increased Power Density for Compact System
- High Frequency Switching
- Reduced Losses for Higher System Efficiency
- Minimized Gate Ringing
- Improved Thermal Capability
- Superior Cost-Performance Index
- Ease of Paralleling without Thermal Runaway
- Simple to Drive

### Applications

- Solar Inverters
- EV/HEV Charging
- Motor Drives
- High Voltage DC-DC Converters
- Switched Mode Power Supplies
- UPS
- Smart Grid Transmission and Distribution
- Induction Heating and Welding

### Absolute Maximum Ratings (At $T_C = 25^\circ C$ Unless Otherwise Stated)

Parameter	Symbol	Conditions	Values	Unit	Note
Drain-Source Voltage	$V_{DS(max)}$	$V_{GS} = 0 V, I_D = 100 \mu A$	1200	V	
Gate-Source Voltage (Dynamic)	$V_{GS(max)}$		-10 / +20	V	
Gate-Source Voltage (Static)	$V_{GS(op)}$	Recommended Operation	-5 / +15	V	
Continuous Forward Current	$I_D$	$T_C = 25^\circ C, V_{GS} = -5 / +15 V$	71	A	Fig. 15
		$T_C = 100^\circ C, V_{GS} = -5 / +15 V$	50		
		$T_C = 135^\circ C, V_{GS} = -5 / +15 V$	37		
Pulsed Drain Current	$I_{D(pulse)}$	$t_P \leq 10 \mu s, D \leq 1\%, \text{Note 1}$	140	A	Fig. 14
Power Dissipation	$P_D$	$T_C = 25^\circ C$	333	W	Fig. 16
Operating and Storage Temperature	$T_j, T_{stg}$		-55 to 175	°C	

### Thermal/Package Characteristics

Parameter	Symbol	Conditions	Values			Unit	Note
			Min.	Typ.	Max.		
Thermal Resistance, Junction - Case	$R_{thJC}$			0.33	0.45	°C/W	Fig. 13
Weight	$W_T$			6.1		g	
Mounting Torque	$T_M$	Screws to Heatsink			1.1	Nm	

Note 1: Pulse Width  $t_P$  Limited by  $T_{j(max)}$

**Electrical Characteristics** (At  $T_c = 25^\circ\text{C}$  Unless Otherwise Stated)

Parameter	Symbol	Conditions	Values			Unit	Note
			Min.	Typ.	Max.		
Drain-Source Breakdown Voltage	$V_{DSS}$	$V_{GS} = 0\text{ V}, I_D = 100\ \mu\text{A}$	1200			V	
Zero Gate Voltage Drain Current	$I_{DSS}$	$V_{DS} = 1200\text{ V}, V_{GS} = 0\text{ V}$		1		$\mu\text{A}$	
Gate Source Leakage Current	$I_{GSS}$	$V_{DS} = 0\text{ V}, V_{GS} = 20\text{ V}$			100	nA	
		$V_{DS} = 0\text{ V}, V_{GS} = -10\text{ V}$			-100		
Gate Threshold Voltage	$V_{GS(th)}$	$V_{DS} = V_{GS}, I_D = 10.0\text{ mA}$		2.69		V	Fig. 9
		$V_{DS} = V_{GS}, I_D = 10.0\text{ mA}, T_j = 175^\circ\text{C}$		2.05			
Transconductance	$g_{fs}$	$V_{DS} = 10\text{ V}, I_D = 35\text{ A}$		14.8		S	Fig. 4
		$V_{DS} = 10\text{ V}, I_D = 35\text{ A}, T_j = 175^\circ\text{C}$		16.7			
Drain-Source On-State Resistance	$R_{DS(on)}$	$V_{GS} = 15\text{ V}, I_D = 35\text{ A}$		40	48	mΩ	Fig. 5-8
		$V_{GS} = 15\text{ V}, I_D = 35\text{ A}, T_j = 175^\circ\text{C}$		55			
Input Capacitance	$C_{iss}$			2929		pF	Fig. 11
Output Capacitance	$C_{oss}$			113			
Reverse Transfer Capacitance	$C_{rss}$	$V_{DS} = 800\text{ V}, V_{GS} = 0\text{ V}$ $f = 1\text{ MHz}, V_{AC} = 25\text{ mV}$		17.9			
$C_{oss}$ Stored Energy	$E_{oss}$			45		$\mu\text{J}$	Fig. 12
$C_{oss}$ Stored Charge	$Q_{oss}$			161		nC	
Gate-Source Charge	$Q_{gs}$	$V_{DS} = 800\text{ V}, V_{GS} = -5 / +15\text{ V}$		30		nC	Fig. 10
Gate-Drain Charge	$Q_{gd}$	$I_D = 35\text{ A}$		46			
Total Gate Charge	$Q_g$	Per IEC607478-4		106			
Internal Gate Resistance	$R_{G(int)}$	$f = 1\text{ MHz}, V_{AC} = 25\text{ mV}$		2.0		Ω	

**Reverse Diode Characteristics**

Parameter	Symbol	Conditions	Values			Unit	Note
			Min.	Typ.	Max.		
Diode Forward Voltage	$V_{SD}$	$V_{GS} = -5\text{ V}, I_{SD} = 17\text{ A}$		4.8		V	Fig. 17-18
		$V_{GS} = -5\text{ V}, I_{SD} = 17\text{ A}, T_j = 175^\circ\text{C}$		4.3			
Continuous Diode Forward Current	$I_S$	$V_{GS} = -5\text{ V}, T_c = 100^\circ\text{C}$	30			A	
Diode Pulse Current	$I_{S(pulse)}$	$V_{GS} = -5\text{ V}, \text{Note 1}$		120		A	

Figure 1: Output Characteristics ( $T_j = 25^\circ\text{C}$ )

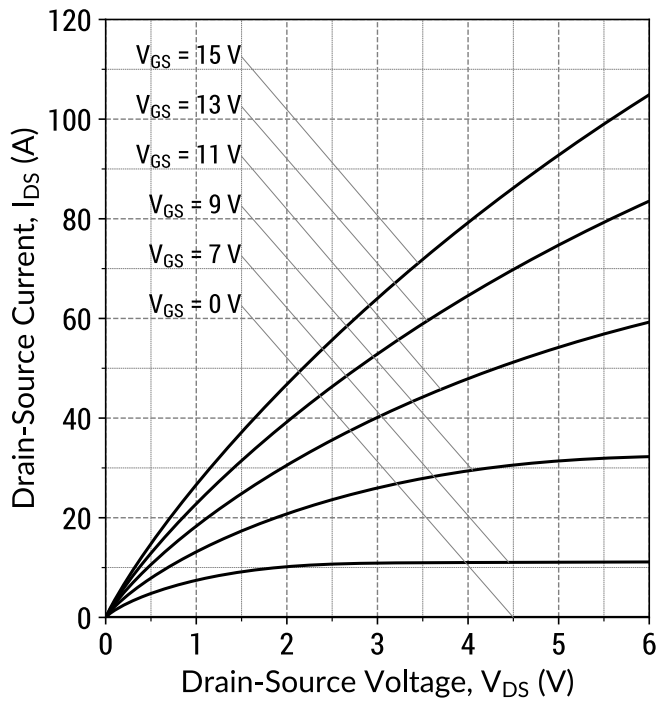

$$I_D = f(V_{DS}, V_{GS}); t_P = 250 \mu\text{s}$$

Figure 2: Output Characteristics ( $T_j = 175^\circ\text{C}$ )

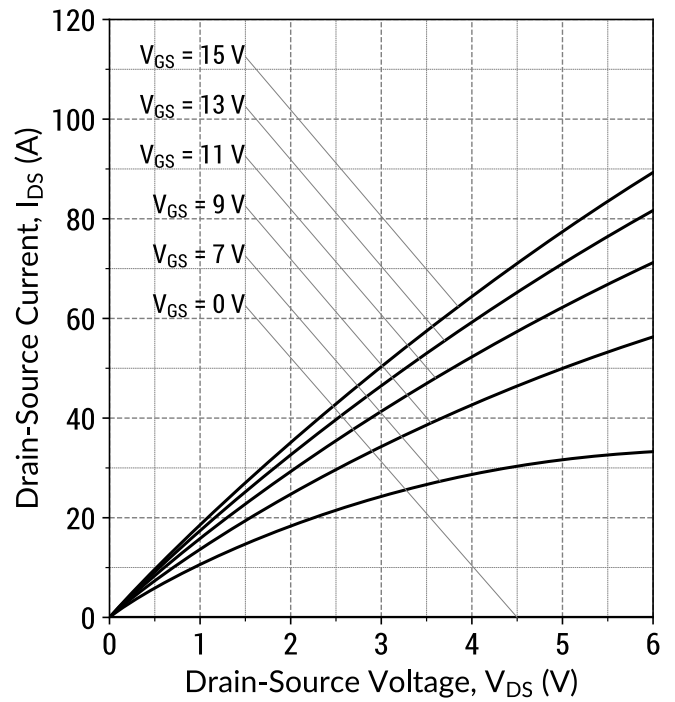

$$I_D = f(V_{DS}, V_{GS}); t_P = 250 \mu\text{s}$$

Figure 3: Output Characteristics ( $V_{GS} = 15 \text{ V}$ )

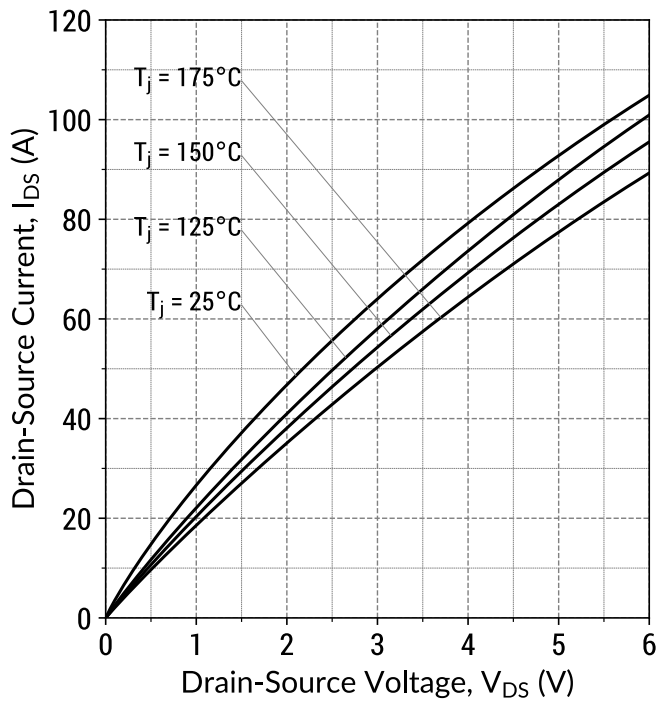

$$I_D = f(V_{DS}, T_j); t_P = 250 \mu\text{s}$$

Figure 4: Transfer Characteristics ( $V_{DS} = 10 \text{ V}$ )

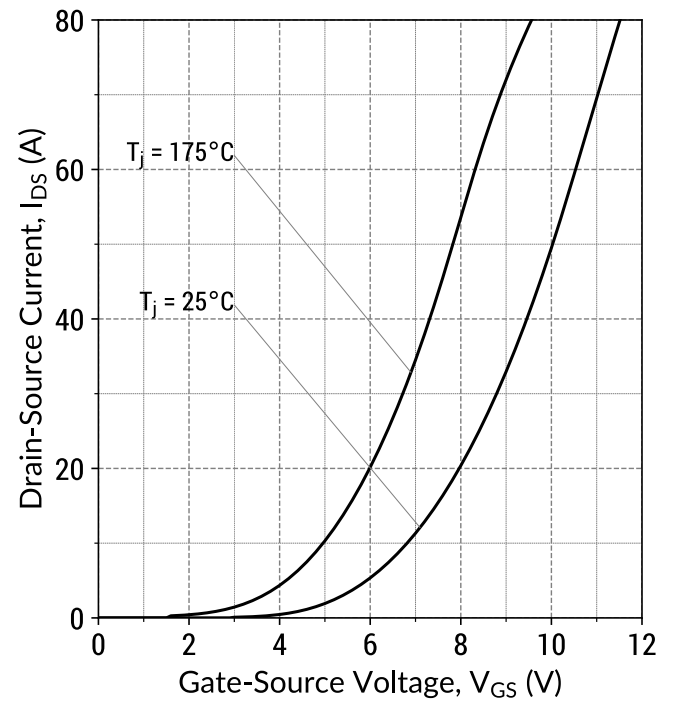

$$I_D = f(V_{GS}, T_j); t_P = 100 \mu\text{s}$$

Figure 5: On-State Resistance v/s Temperature

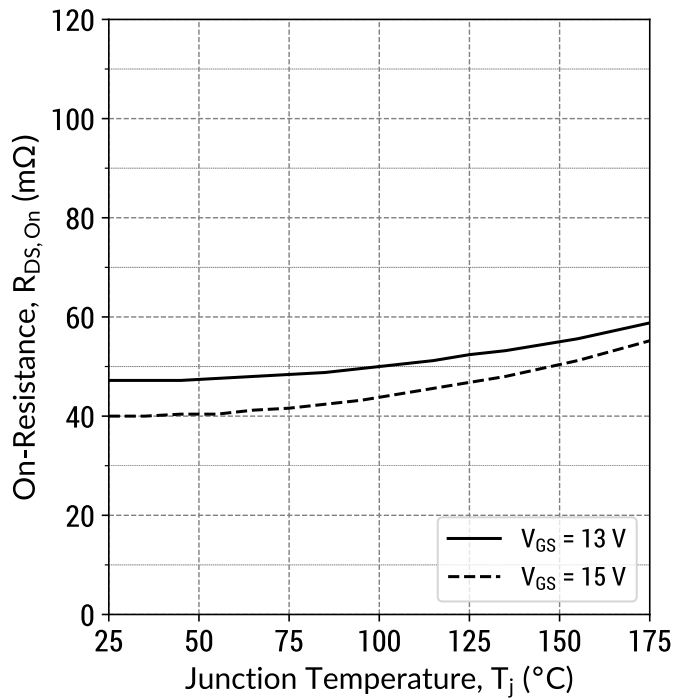

$R_{DS(ON)} = f(T_j, V_{GS}); t_P = 250\ \mu\text{s}; I_D = 35\text{ A}$

Figure 6: On-State Resistance v/s Drain Current

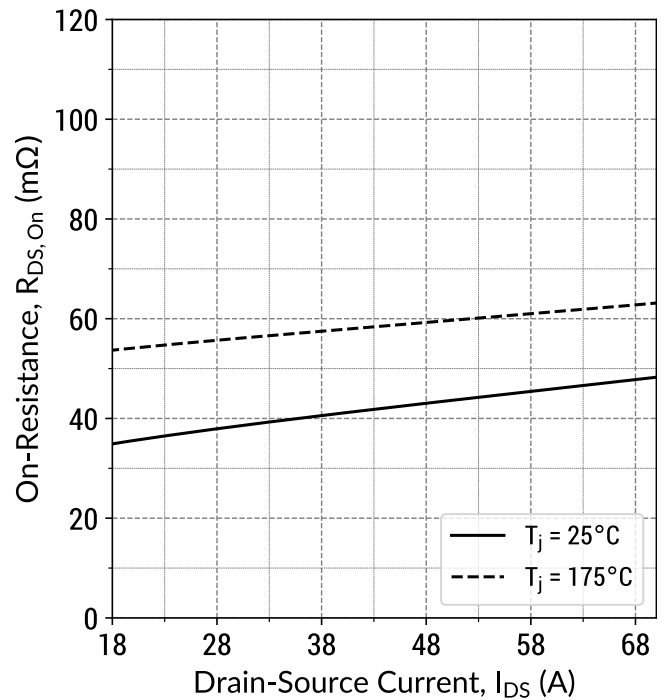

$R_{DS(ON)} = f(T_j, I_D); t_P = 250\ \mu\text{s}; V_{GS} = 15\text{ V}$

Figure 7: Normalized On-State Resistance v/s Temperature

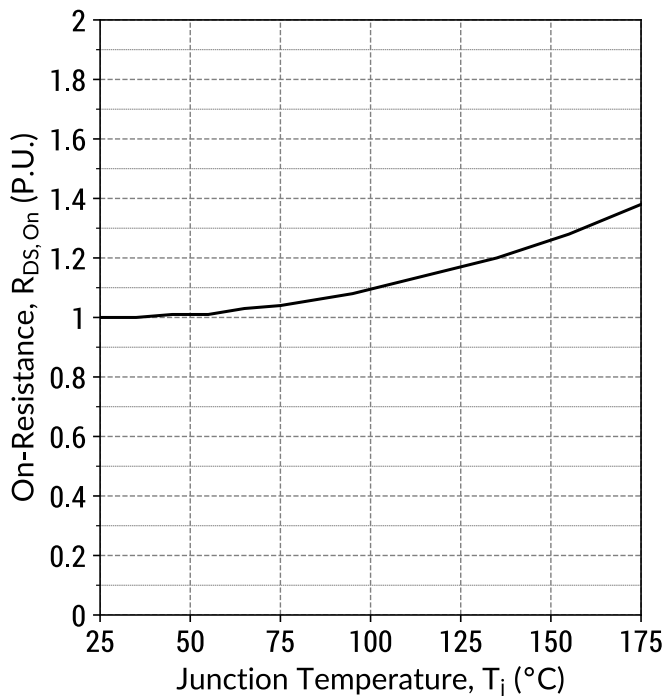

$R_{DS(ON)} = f(T_j); t_P = 250\ \mu\text{s}; I_D = 35\text{ A}; V_{GS} = 15\text{ V}$

Figure 8: On-State Resistance v/s Gate Voltage

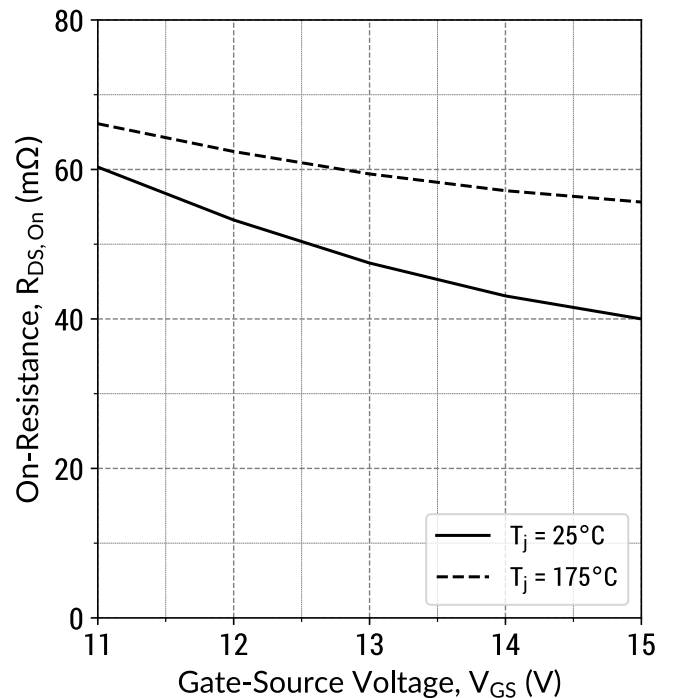

$R_{DS(ON)} = f(T_j, V_{GS}); t_P = 250\ \mu\text{s}; I_D = 35\text{ A}$

Figure 9: Threshold Voltage Characteristics

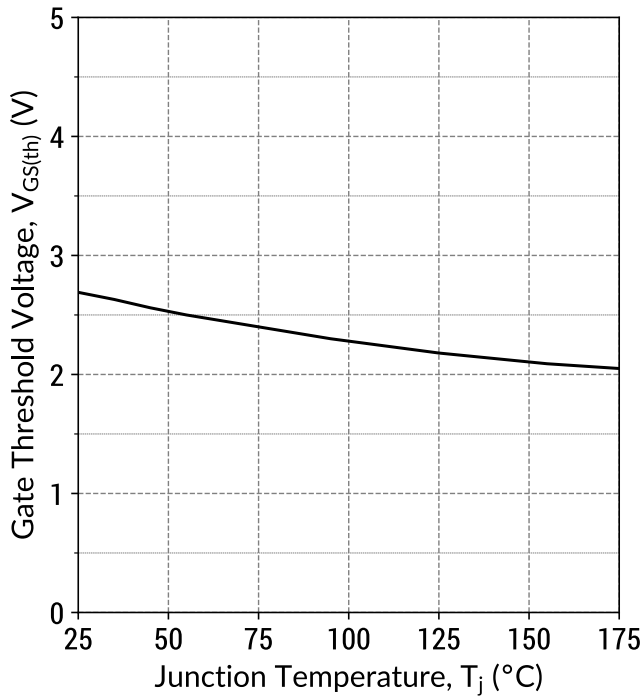

$V_{GS(th)} = f(T_j); V_{DS} = V_{GS}; I_D = 10.0 \text{ mA}$

Figure 10: Gate Charge Characteristics

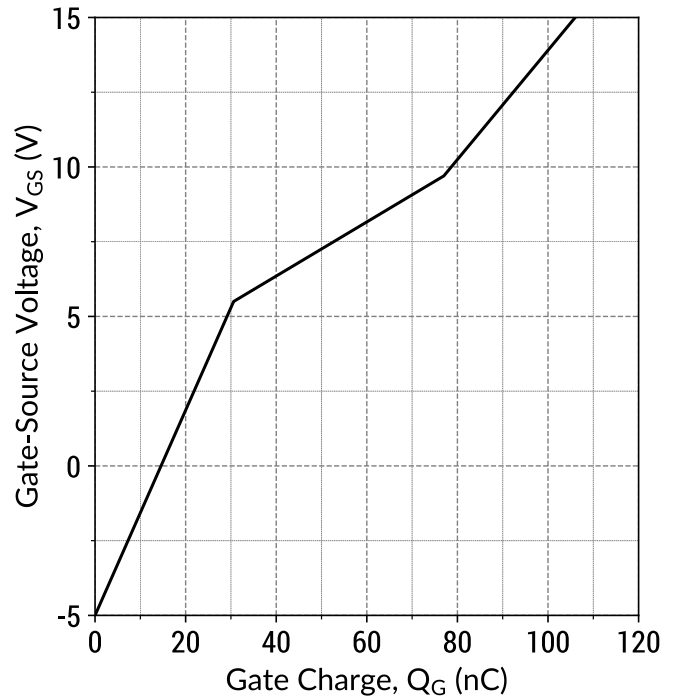

$I_D = 35 \text{ A}; V_{DS} = 800 \text{ V}; T_c = 25^\circ\text{C}$

Figure 11: Capacitance v/s Drain-Source Voltage

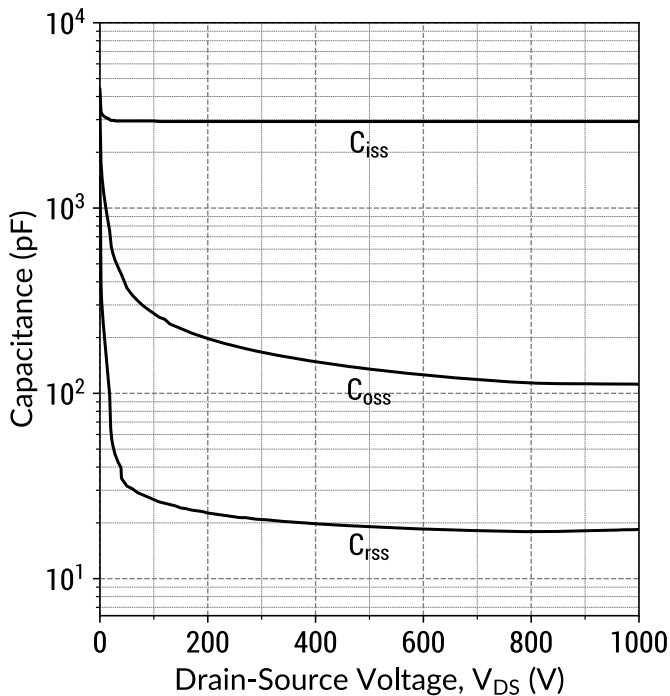

$f = 1 \text{ MHz}; V_{AC} = 25\text{mV}$

Figure 12: Output Capacitor Stored Energy

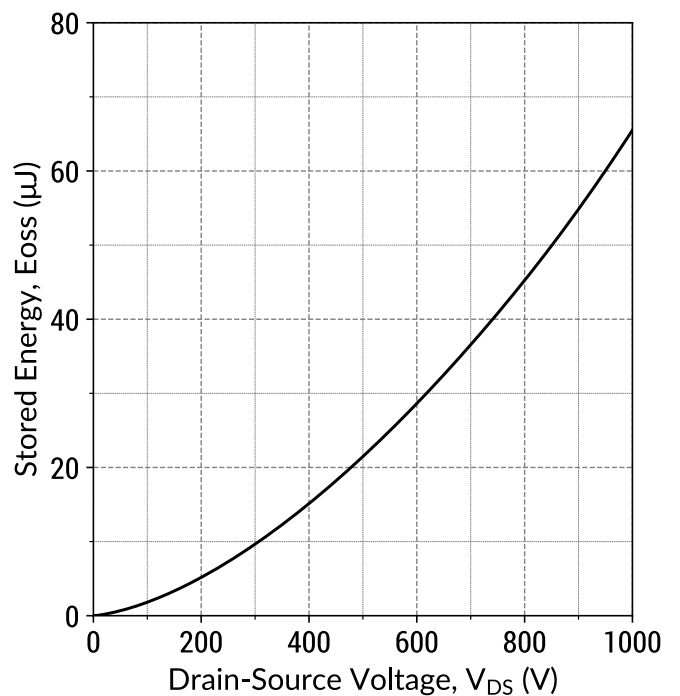

$E_{oss} = f(V_{DS})$

Figure 13: Transient Thermal Impedance

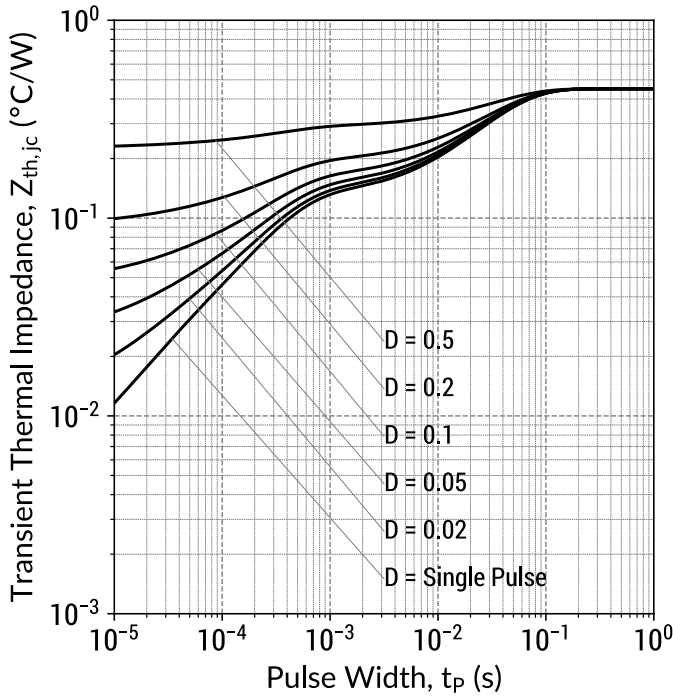

$$Z_{th,jc} = f(t_p, D); D = t_p/T$$

Figure 14: Safe Operating Area ( $T_c = 25^\circ\text{C}$ )

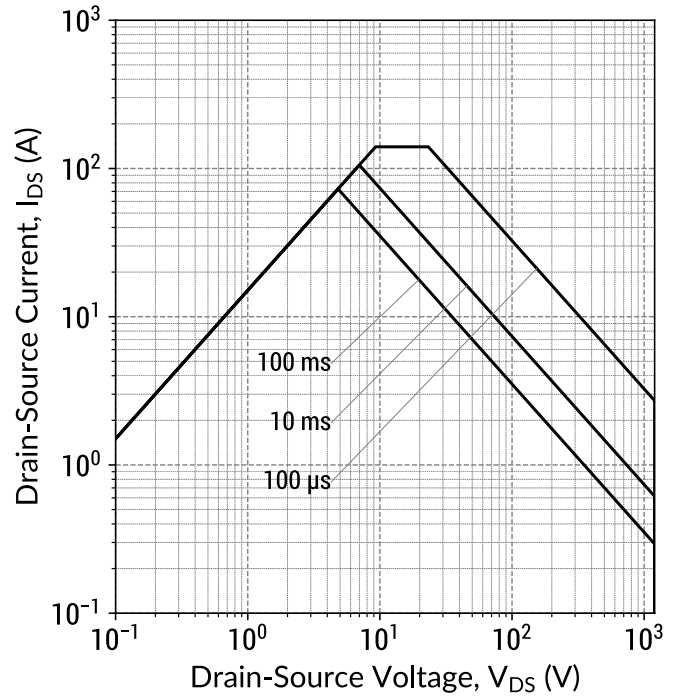

$$I_D = f(V_{DS}, t_p); T_j \leq 175^\circ\text{C}; D = 0$$

Figure 15: Current De-rating Curve

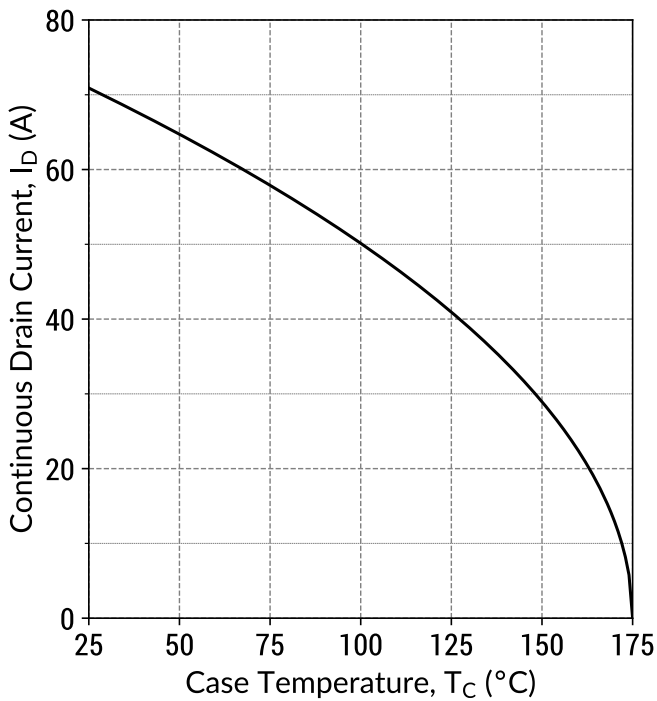

$$I_D = f(T_c); T_j \leq 175^\circ\text{C}$$

Figure 16: Power De-rating Curve

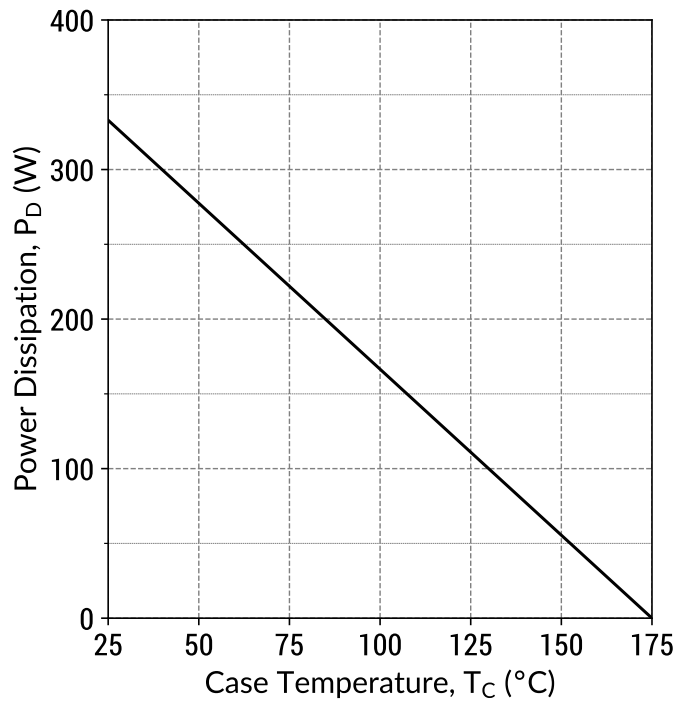

$$P_D = f(T_c); T_j \leq 175^\circ\text{C}$$

Figure 17: Body Diode Characteristics ( $T_j = 25^\circ\text{C}$ )

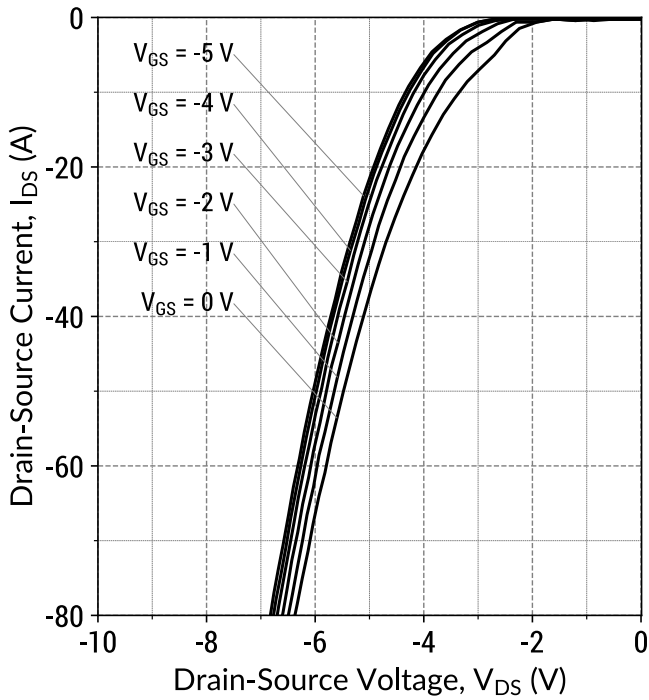

$I_D = f(V_{DS}, V_{GS}); t_P = 250 \mu\text{s}$

Figure 18: Body Diode Characteristics ( $T_j = 175^\circ\text{C}$ )

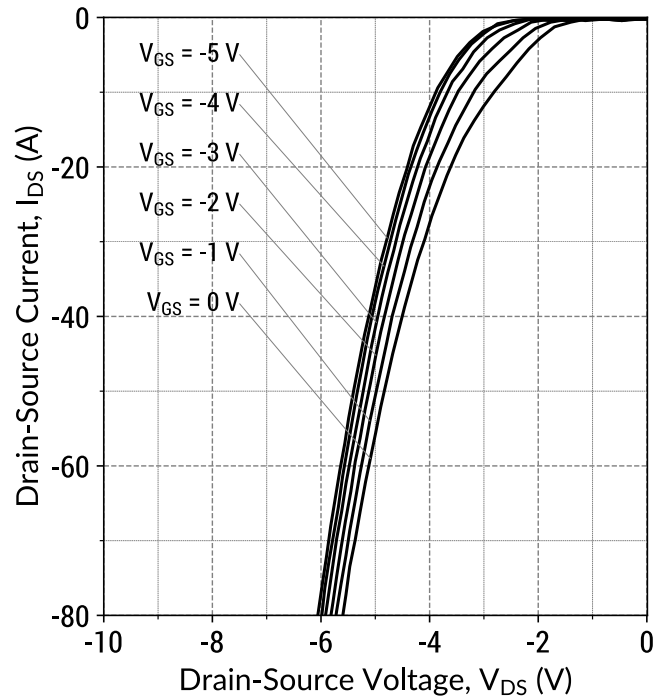

$I_D = f(V_{DS}, V_{GS}); t_P = 250 \mu\text{s}$

Figure 19: Third Quadrant Characteristics ( $T_j = 25^\circ\text{C}$ )

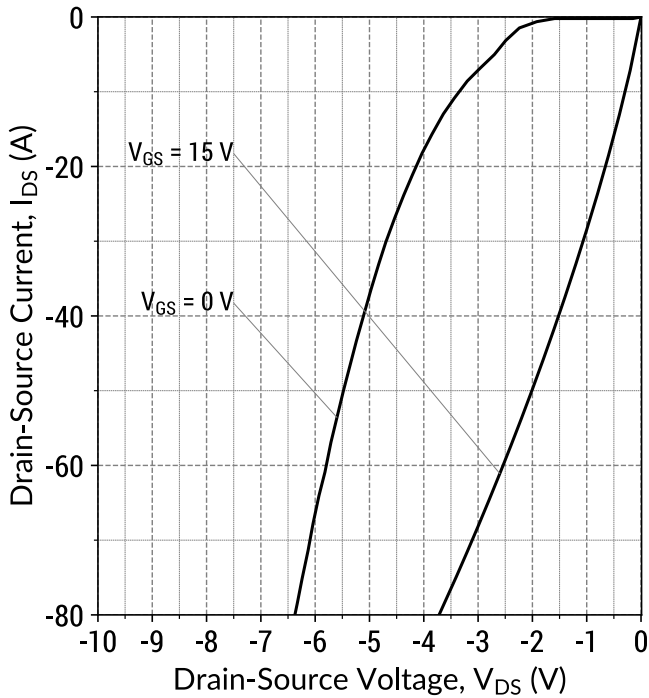

$I_D = f(V_{DS}, V_{GS}); t_P = 250 \mu\text{s}$

Figure 20: Third Quadrant Characteristics ( $T_j = 175^\circ\text{C}$ )

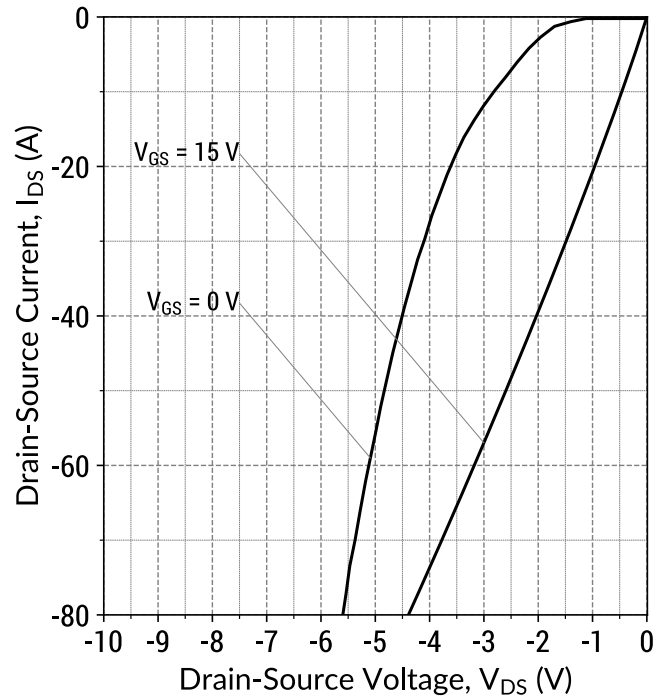

$I_D = f(V_{DS}, V_{GS}); t_P = 250 \mu\text{s}$

Package Dimensions

TO-247-4 Package Outline

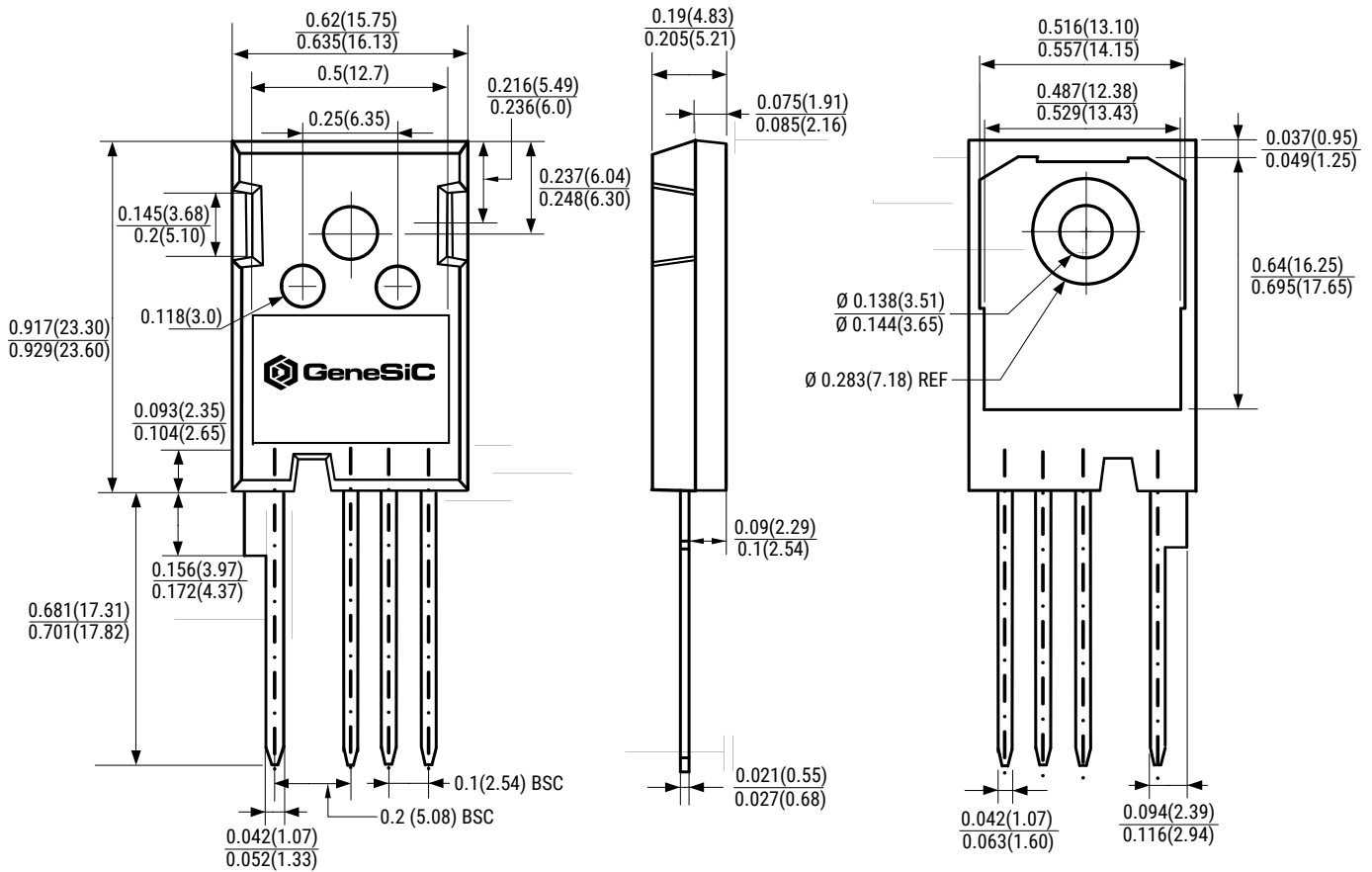

Recommended Solder Pad Layout

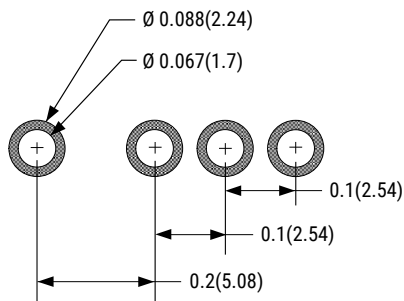

Package View

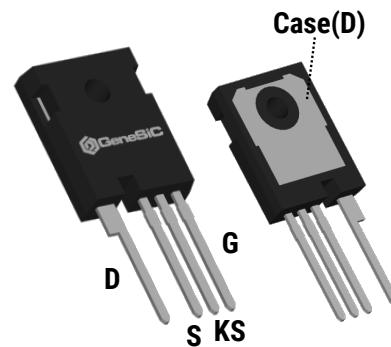

NOTE

1. CONTROLLED DIMENSION IS INCH. DIMENSION IN BRACKET IS MILLIMETER.
2. DIMENSIONS DO NOT INCLUDE END FLASH, MOLD FLASH, MATERIAL PROTRUSIONS.



## Compliance

### RoHS Compliance

The levels of RoHS restricted materials in this product are below the maximum concentration values (also referred to as the threshold limits) permitted for such substances, or are used in an exempted application, in accordance with EU Directive 2011/65/EC (RoHS 2), as adopted by EU member states on January 2, 2013 and amended on March 31, 2015 by EU Directive 2015/863. RoHS Declarations for this product can be obtained from your GeneSiC representative.

### REACH Compliance

REACH substances of high concern (SVHCs) information is available for this product. Since the European Chemical Agency (ECHA) has published notice of their intent to frequently revise the SVHC listing for the foreseeable future, please contact a GeneSiC representative to insure you get the most up-to-date REACH SVHC Declaration. REACH banned substance information (REACH Article 67) is also available upon request.

## Disclaimer

GeneSiC Semiconductor, Inc. reserves right to make changes to the product specifications and data in this document without notice. GeneSiC disclaims all and any warranty and liability arising out of use or application of any product. No license, express or implied to any intellectual property rights is granted by this document.

Unless otherwise expressly indicated, GeneSiC products are not designed, tested or authorized for use in life-saving, medical, aircraft navigation, communication, air traffic control and weapons systems, nor in applications where their failure may result in death, personal injury and/or property damage.

## Related Links

- SPICE Models: [https://www.genesicsemi.com/sic-mosfet/G3R40MT12K/G3R40MT12K\\_SPICE.zip](https://www.genesicsemi.com/sic-mosfet/G3R40MT12K/G3R40MT12K_SPICE.zip)
- PLECS Models: [https://www.genesicsemi.com/sic-mosfet/G3R40MT12K/G3R40MT12K\\_PLECS.zip](https://www.genesicsemi.com/sic-mosfet/G3R40MT12K/G3R40MT12K_PLECS.zip)
- CAD Models: [https://www.genesicsemi.com/sic-mosfet/G3R40MT12K/G3R40MT12K\\_3D.zip](https://www.genesicsemi.com/sic-mosfet/G3R40MT12K/G3R40MT12K_3D.zip)
- Gate Driver Reference: <https://www.genesicsemi.com/technical-support>
- Evaluation Boards: <https://www.genesicsemi.com/technical-support>
- Reliability: <https://www.genesicsemi.com/reliability>
- Compliance: <https://www.genesicsemi.com/compliance>
- Quality Manual: <https://www.genesicsemi.com/quality>

## Revision History

Date	Revision	Comments	Supersedes
Aug. 25, 2020	Rev 2	Recommended Gate Voltage Changed from +20 V/-5 V to +15 V/-5 V	Rev 1
Jun. 2, 2020	Rev 1	Initial Release	



[www.genesicsemi.com/sic-mosfet/](https://www.genesicsemi.com/sic-mosfet/)

## X-ON Electronics

Largest Supplier of Electrical and Electronic Components

*Click to view similar products for [MOSFET](#) category:*

*Click to view products by [GeneSiC Semiconductor](#) manufacturer:*

Other Similar products are found below :

[614233C](#) [648584F](#) [FDPF9N50NZ](#) [IRFD120](#) [JANTX2N5237](#) [2N7000](#) [FCA20N60\\_F109](#) [FDZ595PZ](#) [2SK2545\(Q,T\)](#) [405094E](#) [423220D](#)  
[TPCC8103,L1Q\(CM](#) [MIC4420CM-TR](#) [VN1206L](#) [614234A](#) [715780A](#) [NTNS3166NZT5G](#) [SSM6J414TU,LF\(T](#) [751625C](#) [IPP110N20N3GXX](#)  
[IPS70R2K0CEAKMA1](#) [DMN3404LQ-7](#) [NTE6400](#) [2SK2614\(TE16L1,Q\)](#) [DMN1017UCP3-7](#) [EFC2J004NUZTDG](#) [ECH8691-TL-W](#)  
[FCAB21350L1](#) [P85W28HP2F-7071](#) [DMN1053UCP4-7](#) [NTE221](#) [NTE2384](#) [NTE2903](#) [NTE2941](#) [NTE2945](#) [NTE2946](#) [NTE2960](#) [NTE2969](#)  
[NTE2976](#) [NTE455](#) [NTE6400A](#) [NTE2910](#) [NTE2916](#) [NTE2956](#) [NTE2911](#) [TK10A80W,S4X\(S](#) [SSM6P69NU,LF](#) [DMP22D4UFO-7B](#)  
[DMN1006UCA6-7](#) [DMN16M9UCA6-7](#)