

# GB05MPS17-247

## 1700V 5A SiC Schottky MPS™ Diode



### Silicon Carbide Schottky Diode

|                                |   |        |
|--------------------------------|---|--------|
| $V_{RRM}$                      | = | 1700 V |
| $I_F(T_C = 165^\circ\text{C})$ | = | 5 A    |
| $Q_C$                          | = | 54 nC  |

#### Features

- Low  $V_F$  for High Temperature Operation
- Enhanced Surge and Avalanche Robustness
- Superior Figure of Merit  $Q_C/I_F$
- Low Thermal Resistance
- Low Reverse Leakage Current
- Temperature Independent Fast Switching
- Positive Temperature Coefficient of  $V_F$
- Low  $V_F$  for High Temperature Operation

#### Package

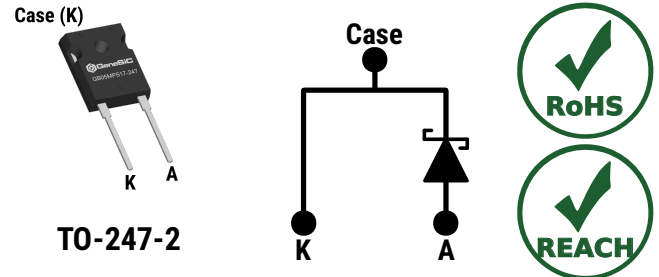

#### Advantages

- Improved System Efficiency
- High System Reliability
- Optimal Price Performance
- Reduced Cooling Requirements
- Increased System Power Density
- Zero Reverse Recovery Current
- Easy to Parallel without Thermal Runaway
- Improved System Efficiency

#### Applications

- EV Fast Chargers
- Solar Inverters
- Anti-Parallel / Free-Wheeling Diode
- Motor Drives
- High Frequency Rectifiers
- Switched Mode Power Supply (SMPS)
- Induction Heating and Welding
- Medical Imaging

#### Absolute Maximum Ratings (At $T_C = 25^\circ\text{C}$ Unless Otherwise Stated)

| Parameter   | Symbol         | Conditions                                     | Values     | Unit                 | Note   |
|---|----------------|--|------------|----------------------|--------|
| Repetitive Peak Reverse Voltage                           | $V_{RRM}$      |  | 1700       | V                    |        |
| Continuous Forward Current                                | $I_F$          | $T_C = 100^\circ\text{C}, D = 1$               | 16         |                      | Fig. 4 |
|   |                | $T_C = 135^\circ\text{C}, D = 1$               | 11         | A                    |        |
|   |                | $T_C = 165^\circ\text{C}, D = 1$               | 5          |                      |        |
| Non-Repetitive Peak Forward Surge Current, Half Sine Wave | $I_{FSM}$      | $T_C = 25^\circ\text{C}, t_P = 10 \text{ ms}$  | 54         | A                    |        |
|   |                | $T_C = 150^\circ\text{C}, t_P = 10 \text{ ms}$ | 43         |                      |        |
| Repetitive Peak Forward Surge Current, Half Sine Wave     | $I_{FRM}$      | $T_C = 25^\circ\text{C}, t_P = 10 \text{ ms}$  | 32         | A                    |        |
|   |                | $T_C = 150^\circ\text{C}, t_P = 10 \text{ ms}$ | 22         |                      |        |
| Non-Repetitive Peak Forward Surge Current                 | $I_{FMAX}$     | $T_C = 25^\circ\text{C}, t_P = 10 \mu\text{s}$ | 270        | A                    |        |
| $i^2t$ Value  | $\int i^2 dt$  | $T_C = 25^\circ\text{C}, t_P = 10 \text{ ms}$  | 14         | $\text{A}^2\text{s}$ |        |
| Non-Repetitive Avalanche Energy                           | $E_{AS}$       | $L = 10.4 \text{ mH}, I_{AS} = 5 \text{ A}$    | 131        | mJ                   |        |
| Diode Ruggedness  | $dV/dt$        | $V_R = 0 \sim 1360 \text{ V}$                  | 200        | V/ns                 |        |
| Power Dissipation   | $P_{TOT}$      | $T_C = 25^\circ\text{C}$                       | 155        | W                    | Fig. 3 |
| Operating and Storage Temperature                         | $T_j, T_{stg}$ |  | -55 to 175 | $^\circ\text{C}$     |        |

### Electrical Characteristics

| Parameter               | Symbol | Conditions  | Values  |            |      | Unit          | Note   |
|-------------------------|--------|---|---|------------|------|---------------|--------|
|                         |        |   | Min.  | Typ.       | Max. |               |        |
| Diode Forward Voltage   | $V_F$  | $I_F = 5\text{ A}, T_j = 25^\circ\text{C}$<br>$I_F = 5\text{ A}, T_j = 175^\circ\text{C}$       |   | 1.5<br>2.1 | 1.8  | V             | Fig. 1 |
| Reverse Current         | $I_R$  | $V_R = 1700\text{ V}, T_j = 25^\circ\text{C}$<br>$V_R = 1700\text{ V}, T_j = 175^\circ\text{C}$ |   | 1<br>5     | 10   | $\mu\text{A}$ | Fig. 2 |
| Total Capacitive Charge | $Q_C$  | $I_F \leq I_{F,MAX}$<br>$di_F/dt = 200\text{ A}/\mu\text{s}$                                    |   | 37<br>54   |      | nC            | Fig. 7 |
|                         |        |   | $V_R = 600\text{ V}$<br>$V_R = 1200\text{ V}$ |            |      |               |        |
| Switching Time          | $t_s$  |   |   | < 10       |      | ns            |        |
|                         |        | $V_R = 600\text{ V}$<br>$V_R = 1200\text{ V}$   |   |            |      |               |        |
| Total Capacitance       | $C$    | $V_R = 1\text{ V}, f = 1\text{ MHz}$<br>$V_R = 1200\text{ V}, f = 1\text{ MHz}$                 |   | 470<br>26  |      | pF            | Fig. 6 |

### Thermal/Package Characteristics

| Parameter                           | Symbol     | Conditions         | Values |      |      | Unit                      | Note   |
|-------------------------------------|------------|--------------------|--------|------|------|---------------------------|--------|
|                                     |            |                    | Min.   | Typ. | Max. |                           |        |
| Thermal Resistance, Junction - Case | $R_{thJC}$ |                    |        | 0.97 |      | $^\circ\text{C}/\text{W}$ | Fig. 9 |
| Weight                              | $W_T$      |                    |        | 6.0  |      | g                         |        |
| Mounting Torque                     | $T_M$      | Screws to Heatsink |        |      | 1.1  | Nm                        |        |

Figure 1: Typical Forward Characteristics

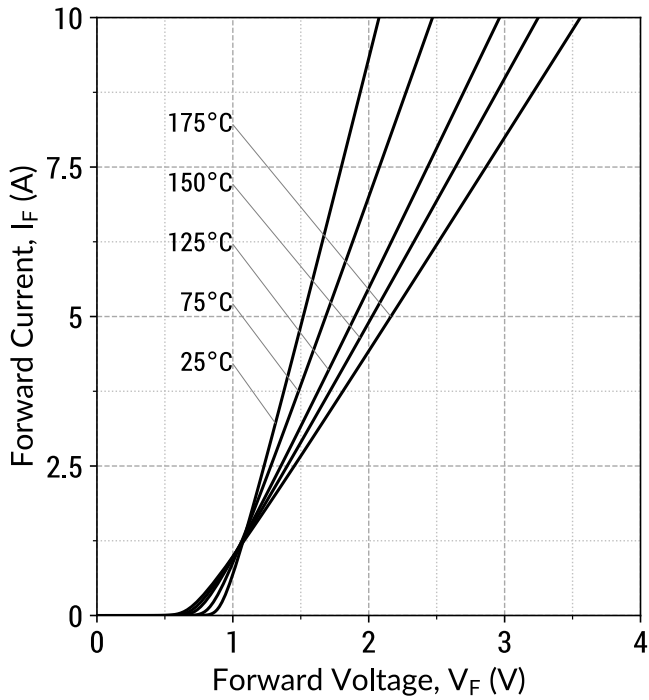

$$I_F = f(V_F, T_j); t_P = 250 \mu s$$

Figure 2: Typical Reverse Characteristics

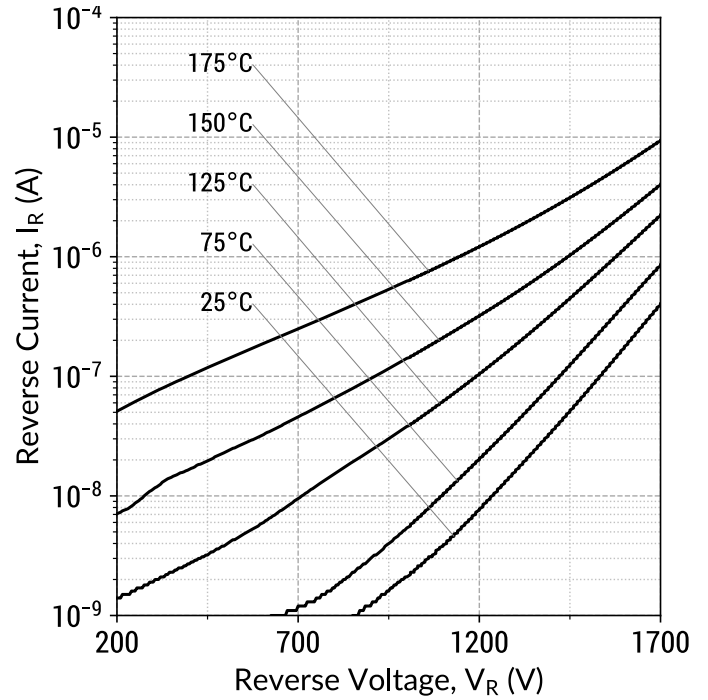

$$I_R = f(V_R, T_j)$$

Figure 3: Power Derating Curves

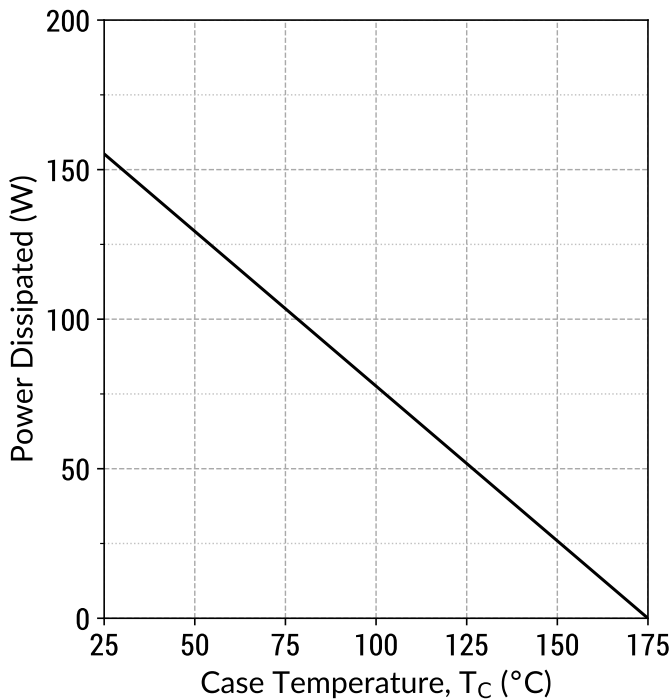

$$P_{TOT} = f(T_C); T_j = 175^\circ C$$

Figure 4: Current Derating Curves (Typical  $V_F$ )

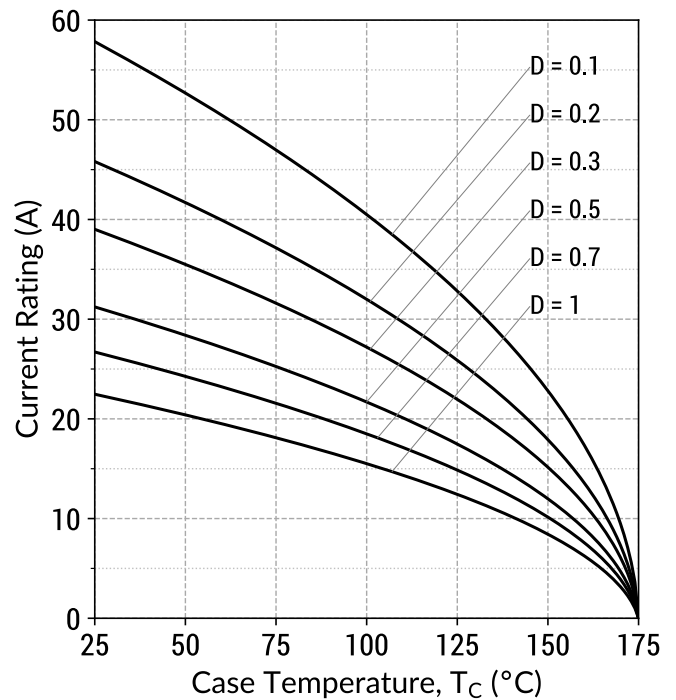

$$I_F = f(T_C); D = t_P/T; T_j \leq 175^\circ C; f_{sw} > 10kHz$$

Figure 5: Current Derating Curves (Maximum  $V_F$ )

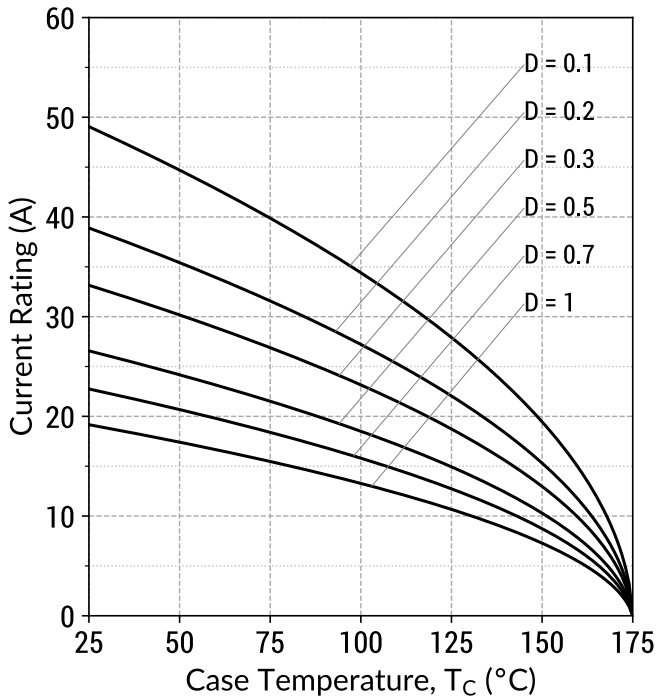

$I_F = f(T_C)$ ;  $D = t_P/T$ ;  $T_J \leq 175^\circ\text{C}$ ;  $f_{SW} > 10\text{kHz}$

Figure 6: Typical Junction Capacitance vs Reverse Voltage Characteristics

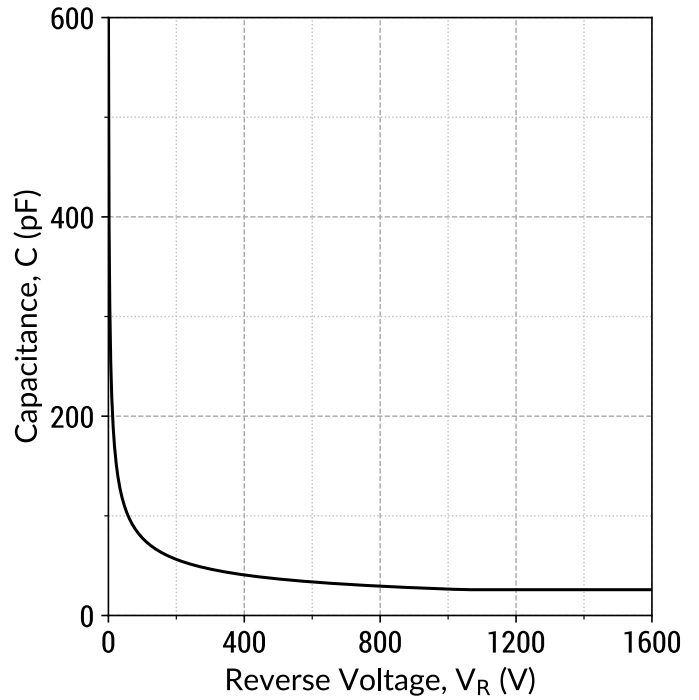

$C = f(V_R)$ ;  $f = 1\text{MHz}$

Figure 7: Typical Capacitive Charge vs Reverse Voltage Characteristics

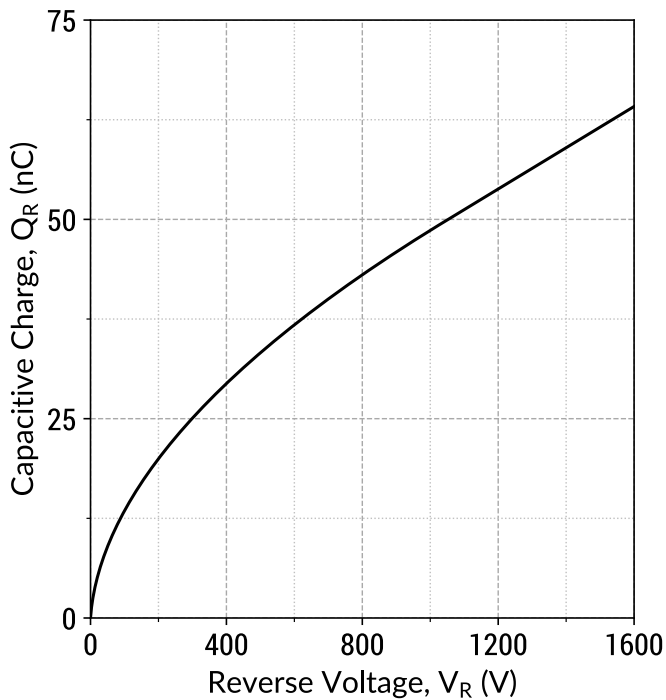

$Q_C = f(V_R)$ ;  $f = 1\text{MHz}$

Figure 8: Typical Capacitive Energy vs Reverse Voltage Characteristics

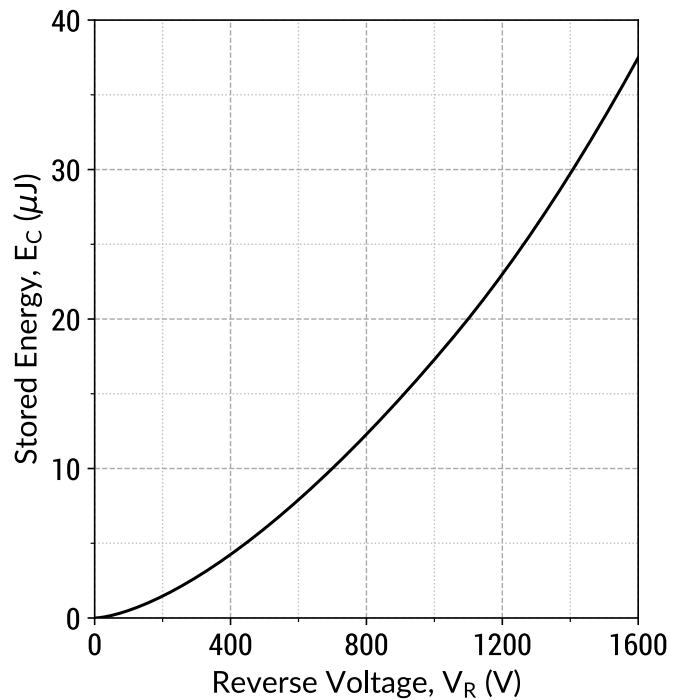

$E_C = f(V_R)$ ;  $f = 1\text{MHz}$

Figure 9: Transient Thermal Impedance

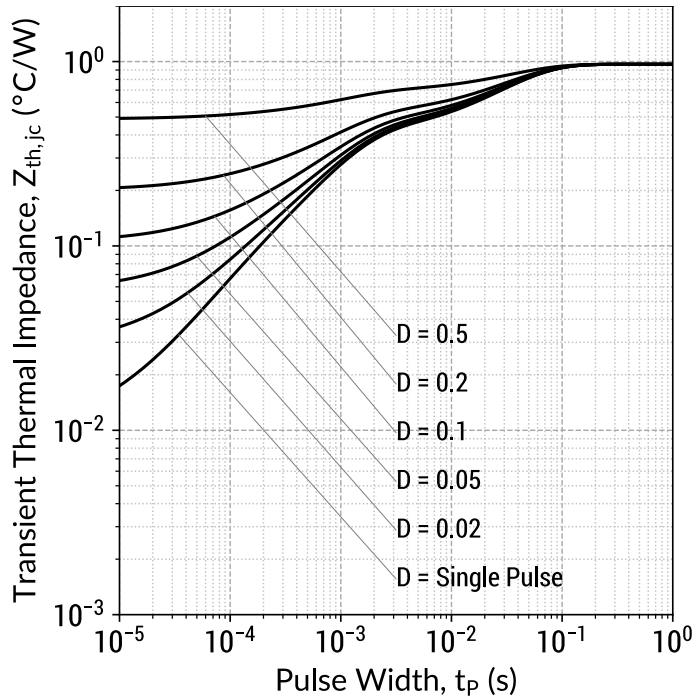

$$Z_{th,jc} = f(t_p, D); D = t_p/T$$

Figure 10: Forward Curve Model



$$I_F = f(V_F, T_j)$$

**Forward Curve Model Equation:**

$$I_F = (V_F - V_{BI})/R_{DIFF} \text{ (A)}$$

**Built-In Voltage ( $V_{BI}$ ):**

$$V_{BI}(T_j) = m \times T_j + n \text{ (V)}$$

$$m = -0.00128 \text{ (V/°C)}$$

$$n = 0.99 \text{ (V)}$$

**Differential Resistance ( $R_{DIFF}$ ):**

$$R_{DIFF}(T_j) = a \times T_j^2 + b \times T_j + c \text{ (}\Omega\text{)}$$

$$a = 2.03e-06 \text{ (}\Omega\text{/°C}^2\text{)}$$

$$b = 0.000711 \text{ (}\Omega\text{/°C)}$$

$$c = 0.093 \text{ (}\Omega\text{)}$$

**Forward Power Loss Equation:**

$$P_{LOSS} = V_{BI}(T_j) \times I_{AVG} + R_{DIFF}(T_j) \times I_{RMS}^2$$

Package Dimensions

TO-247-2 Package Outline

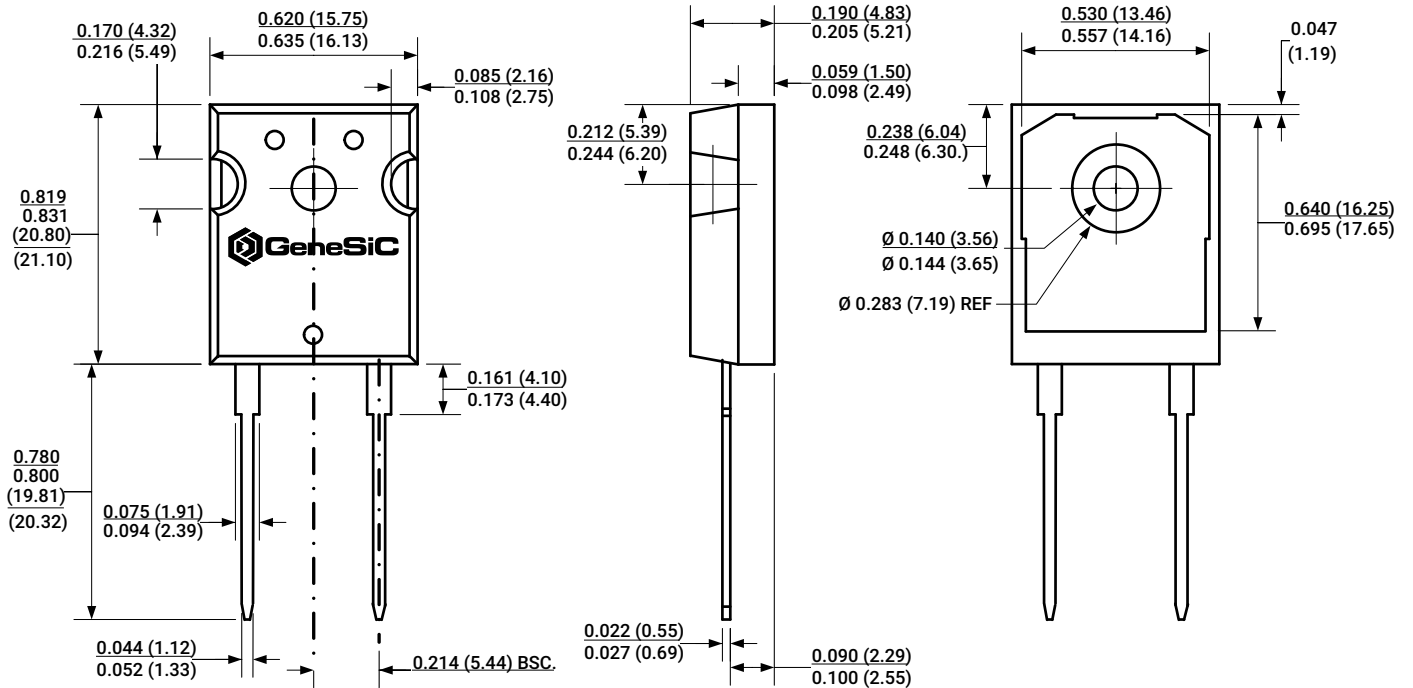

Recommended Solder Pad Layout

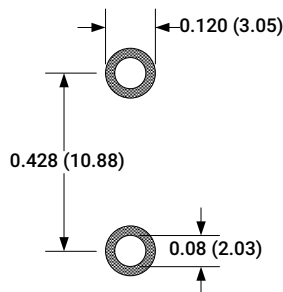

Package View

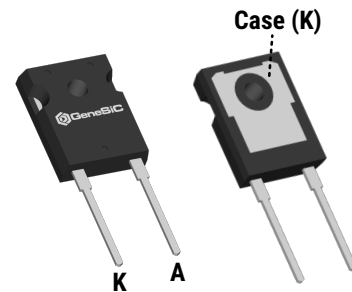

NOTE

1. CONTROLLED DIMENSION IS INCH. DIMENSION IN BRACKET IS MILLIMETER.
2. DIMENSIONS DO NOT INCLUDE END FLASH, MOLD FLASH, MATERIAL PROTRUSIONS.

## Compliance

### RoHS Compliance

The levels of RoHS restricted materials in this product are below the maximum concentration values (also referred to as the threshold limits) permitted for such substances, or are used in an exempted application, in accordance with EU Directive 2011/65/EC (RoHS 2), as adopted by EU member states on January 2, 2013 and amended on March 31, 2015 by EU Directive 2015/863. RoHS Declarations for this product can be obtained from your GeneSiC representative.

### REACH Compliance

REACH substances of high concern (SVHCs) information is available for this product. Since the European Chemical Agency (ECHA) has published notice of their intent to frequently revise the SVHC listing for the foreseeable future, please contact a GeneSiC representative to insure you get the most up-to-date REACH SVHC Declaration. REACH banned substance information (REACH Article 67) is also available upon request.

## Disclaimer

GeneSiC Semiconductor, Inc. reserves right to make changes to the product specifications and data in this document without notice. GeneSiC disclaims all and any warranty and liability arising out of use or application of any product. No license, express or implied to any intellectual property rights is granted by this document.

Unless otherwise expressly indicated, GeneSiC products are not designed, tested or authorized for use in life-saving, medical, aircraft navigation, communication, air traffic control and weapons systems, nor in applications where their failure may result in death, personal injury and/or property damage.

## Related Links

- SPICE Models: [https://www.genesicsemi.com/sic-schottky-mps/GB05MPS17-247/GB05MPS17-247\\_SPICE.zip](https://www.genesicsemi.com/sic-schottky-mps/GB05MPS17-247/GB05MPS17-247_SPICE.zip)
- PLECS Models: [https://www.genesicsemi.com/sic-schottky-mps/GB05MPS17-247/GB05MPS17-247\\_PLECS.zip](https://www.genesicsemi.com/sic-schottky-mps/GB05MPS17-247/GB05MPS17-247_PLECS.zip)
- CAD Models: [https://www.genesicsemi.com/sic-schottky-mps/GB05MPS17-247/GB05MPS17-247\\_3D.zip](https://www.genesicsemi.com/sic-schottky-mps/GB05MPS17-247/GB05MPS17-247_3D.zip)
- Evaluation Boards: <https://www.genesicsemi.com/technical-support>
- Reliability: <https://www.genesicsemi.com/reliability>
- Compliance: <https://www.genesicsemi.com/compliance>
- Quality Manual: <https://www.genesicsemi.com/quality>

## Revision History

- Rev 21/Jun: Updated with most recent test data
- Supersedes: Rev 19/Apr, Rev 20/Apr, Rev 20/Aug



[www.genesicsemi.com/sic-schottky-mps/](https://www.genesicsemi.com/sic-schottky-mps/)

## X-ON Electronics

Largest Supplier of Electrical and Electronic Components

*Click to view similar products for [Schottky Diodes & Rectifiers](#) category:*

*Click to view products by [GeneSiC Semiconductor](#) manufacturer:*

Other Similar products are found below :

[MA4E2039](#) [D1FH3-5063](#) [MBR0530L-TP](#) [MBR10100CT-BP](#) [MBR1545CT](#) [MMBD301M3T5G](#) [RB160M-50TR](#) [RB551V-30](#)  
[BAS16E6433HTMA1](#) [BAT 54-02LRH E6327](#) [NSR05F40QNXT5G](#) [JANS1N6640](#) [SB07-03C-TB-H](#) [SB1003M3-TL-W](#) [SK310-T](#) [SK32A-](#)  
[LTP](#) [SK34B-TP](#) [SS3003CH-TL-E](#) [GA01SHT18](#) [CRS10I30A\(TE85L,QM](#) [MA4E2501L-1290](#) [MBRB30H30CT-1G](#) [SB007-03C-TB-E](#)  
[SK32A-TP](#) [SK33B-TP](#) [SK38B-TP](#) [NRVBM120LT1G](#) [NTE505](#) [NTSB30U100CT-1G](#) [SS15E-TP](#) [VS-6CWQ10FNHM3](#) [ACDBA1100LR-HF](#)  
[ACDBA1200-HF](#) [ACDBA140-HF](#) [ACDBA2100-HF](#) [ACDBA3100-HF](#) [CDBQC0530L-HF](#) [CDBQC0240LR-HF](#) [ACDBA260LR-HF](#)  
[ACDBA1100-HF](#) [SK310B-TP](#) [MA4E2502L-1246](#) [MA4E2502H-1246](#) [NRVBM120ET1G](#) [NSR01L30MXT5G](#) [SB560](#) [PMAD1108-LF](#)  
[SD103ATW-TP](#) [1N5819T-G](#) [PDS1040Q-13](#)