

## Silicon Carbide Power Schottky Diode

$V_{RRM}$	=	<b>1200 V</b>
$I_F (T_C = 25^\circ\text{C})$	=	<b>12 A</b>
$Q_C$	=	<b>21 nC</b>

### Features

- 1200 V Schottky rectifier
- 175 °C maximum operating temperature
- Temperature independent switching behavior
- Superior surge current capability
- Positive temperature coefficient of  $V_F$
- Extremely fast switching speeds
- Superior figure of merit  $Q_C/I_F$

### Package

- RoHS Compliant

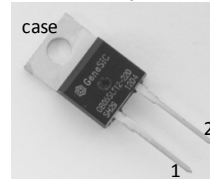
**TO – 220AC**

### Advantages

- Improved circuit efficiency (Lower overall cost)
- Low switching losses
- Ease of paralleling devices without thermal runaway
- Smaller heat sink requirements
- Low reverse recovery current
- Low device capacitance
- Low reverse leakage current at operating temperature

### Applications

- Power Factor Correction (PFC)
- Switched-Mode Power Supply (SMPS)
- Solar Inverters
- Wind Turbine Inverters
- Motor Drives
- Induction Heating
- Uninterruptible Power Supply (UPS)
- High Voltage Multipliers

### Maximum Ratings at $T_j = 175^\circ\text{C}$ , unless otherwise specified

Parameter	Symbol	Conditions	Values	Unit
Repetitive peak reverse voltage	$V_{RRM}$		1200	V
Continuous forward current	$I_F$	$T_C \leq 155^\circ\text{C}$	5	A
RMS forward current	$I_{F(RMS)}$	$T_C \leq 155^\circ\text{C}$	8	A
Surge non-repetitive forward current, Half Sine Wave	$I_{F,SM}$	$T_C = 25^\circ\text{C}$ , $t_p = 10\text{ ms}$	32	A
		$T_C = 155^\circ\text{C}$ , $t_p = 10\text{ ms}$	26	
Non-repetitive peak forward current	$I_{F,max}$	$T_C = 25^\circ\text{C}$ , $t_p = 10\text{ }\mu\text{s}$	120	A
$I^2t$ value	$\int i^2 dt$	$T_C = 25^\circ\text{C}$ , $t_p = 10\text{ ms}$	5	A <sup>2</sup> s
		$T_C = 155^\circ\text{C}$ , $t_p = 10\text{ ms}$	3.4	
Power dissipation	$P_{tot}$	$T_C = 25^\circ\text{C}$	117	W
Operating and storage temperature	$T_j, T_{stg}$		-55 to 175	°C

### Electrical Characteristics at $T_j = 175^\circ\text{C}$ , unless otherwise specified

Parameter	Symbol	Conditions	Values			Unit
			min.	typ.	max.	
Diode forward voltage	$V_F$	$I_F = 5\text{ A}$ , $T_j = 25^\circ\text{C}$		1.6	1.9	V
		$I_F = 5\text{ A}$ , $T_j = 175^\circ\text{C}$		2.6	3.0	
Reverse current	$I_R$	$V_R = 1200\text{ V}$ , $T_j = 25^\circ\text{C}$		5	50	$\mu\text{A}$
		$V_R = 1200\text{ V}$ , $T_j = 175^\circ\text{C}$		10	100	
Total capacitive charge	$Q_C$	$I_F \leq I_{F,MAX}$ $di_F/dt = 200\text{ A}/\mu\text{s}$ $T_j = 175^\circ\text{C}$	$V_R = 400\text{ V}$	21		nC
			$V_R = 960\text{ V}$	35		
Switching time	$t_s$		$V_R = 400\text{ V}$	< 25		ns
			$V_R = 960\text{ V}$			
Total capacitance	C	$V_R = 1\text{ V}$ , $f = 1\text{ MHz}$ , $T_j = 25^\circ\text{C}$		260		pF
		$V_R = 400\text{ V}$ , $f = 1\text{ MHz}$ , $T_j = 25^\circ\text{C}$		25		
		$V_R = 1000\text{ V}$ , $f = 1\text{ MHz}$ , $T_j = 25^\circ\text{C}$		20		

### Thermal Characteristics

Thermal resistance, junction - case	$R_{thJC}$	1.4	°C/W
-------------------------------------	------------	-----	------

### Mechanical Properties

Mounting torque	M	0.6	Nm
-----------------	---	-----	----

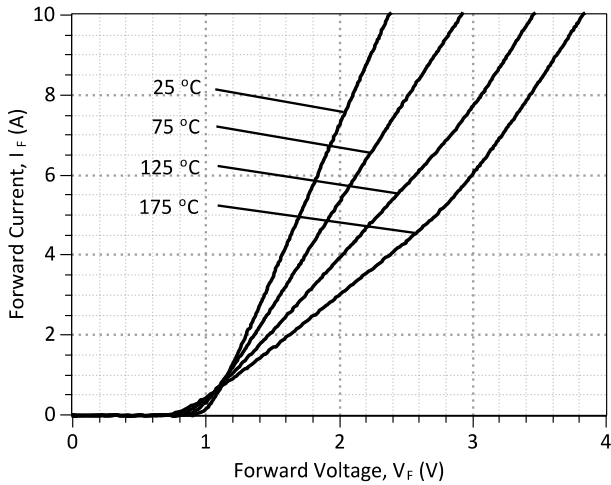

**Figure 1: Typical Forward Characteristics**

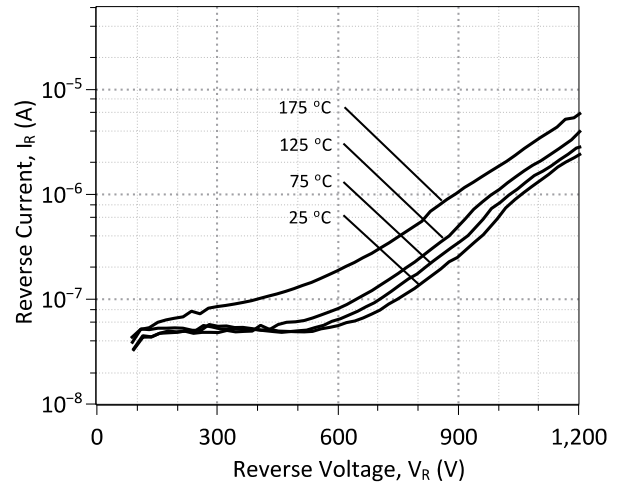

**Figure 2: Typical Reverse Characteristics**

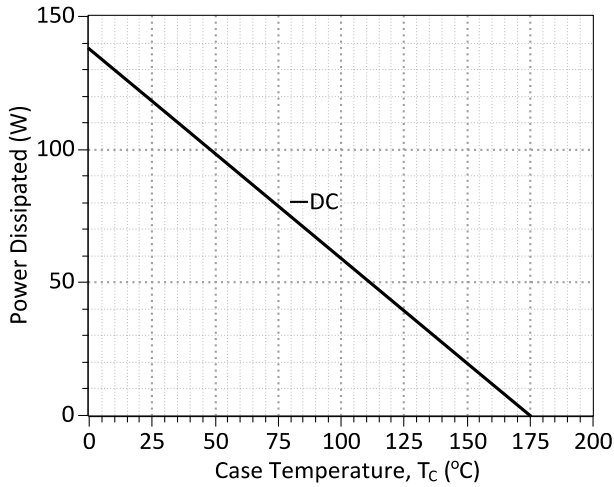

**Figure 3: Power Derating Curve**

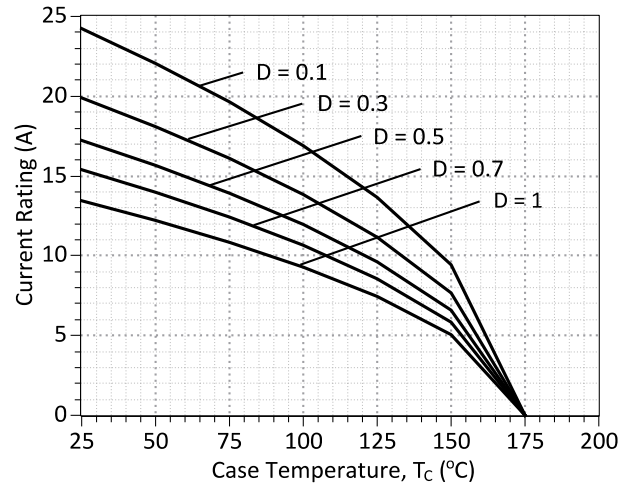

**Figure 4: Current Derating Curves ( $D = t_p/T$ ,  $t_p = 400 \mu s$ )  
(Considering worst case  $Z_{th}$  conditions)**

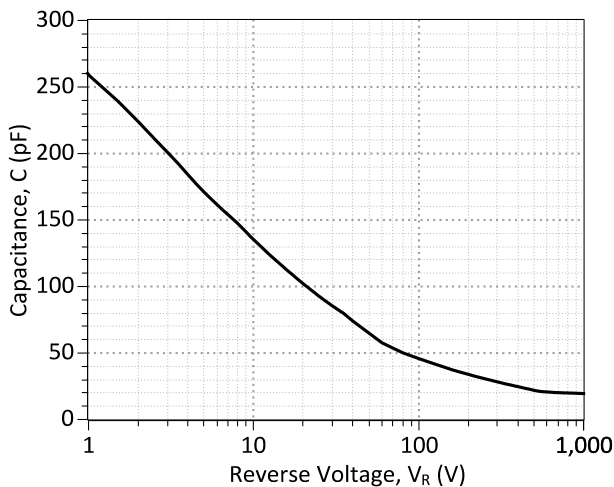

**Figure 5: Typical Junction Capacitance vs Reverse Voltage Characteristics**

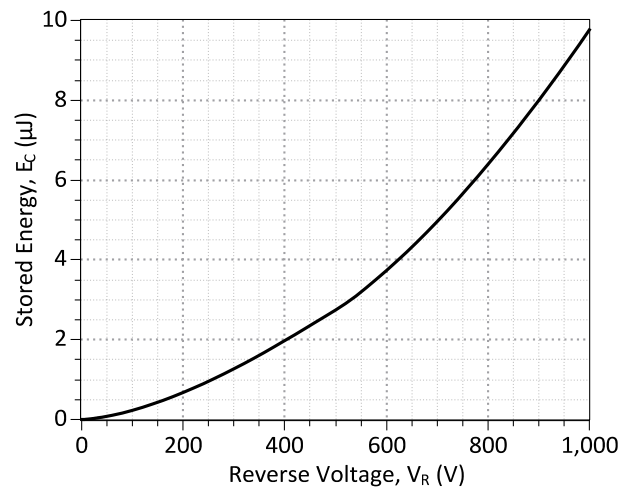

**Figure 6: Typical Switching Energy vs Reverse Voltage Characteristics**

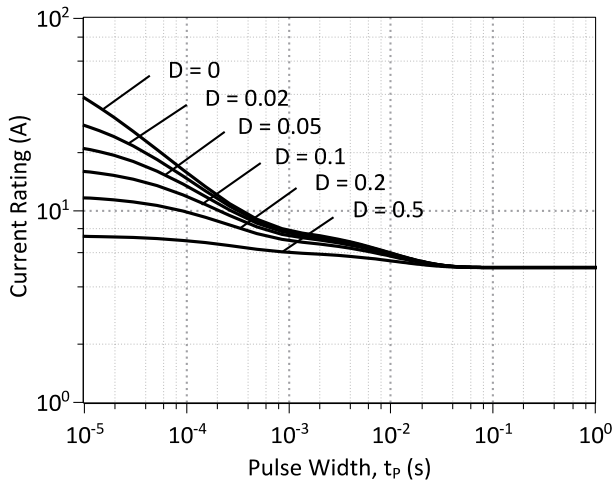

Figure 7: Current vs Pulse Duration Curves at  $T_c = 155\text{ }^\circ\text{C}$

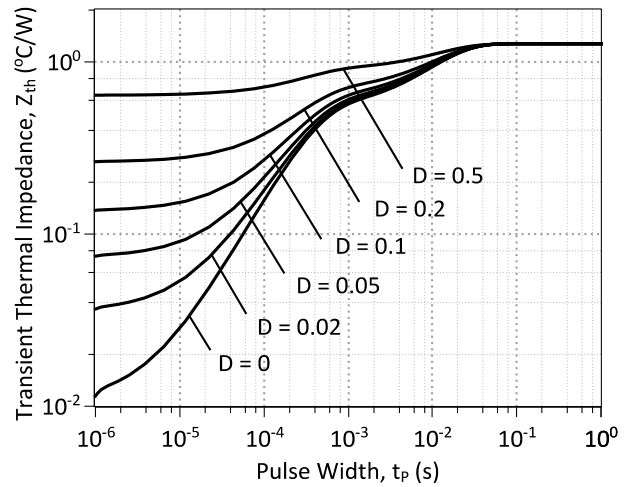
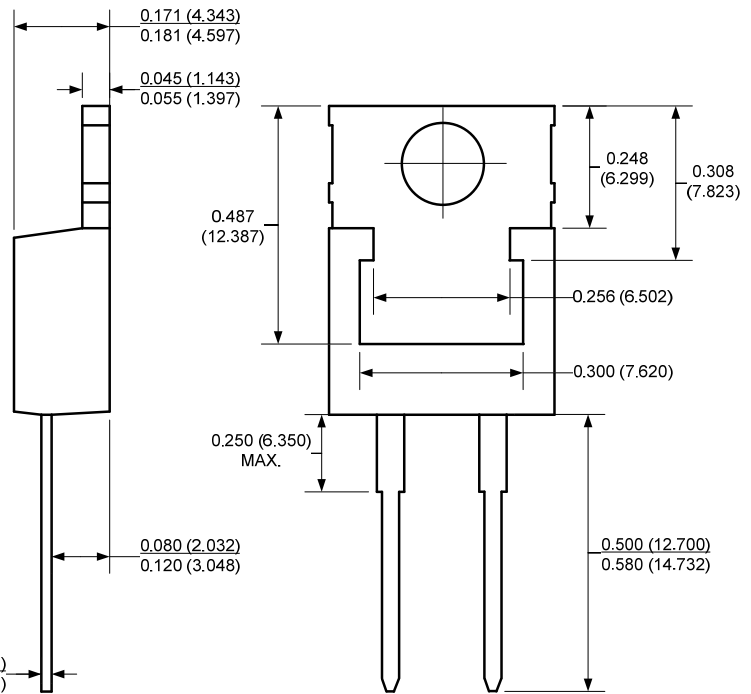
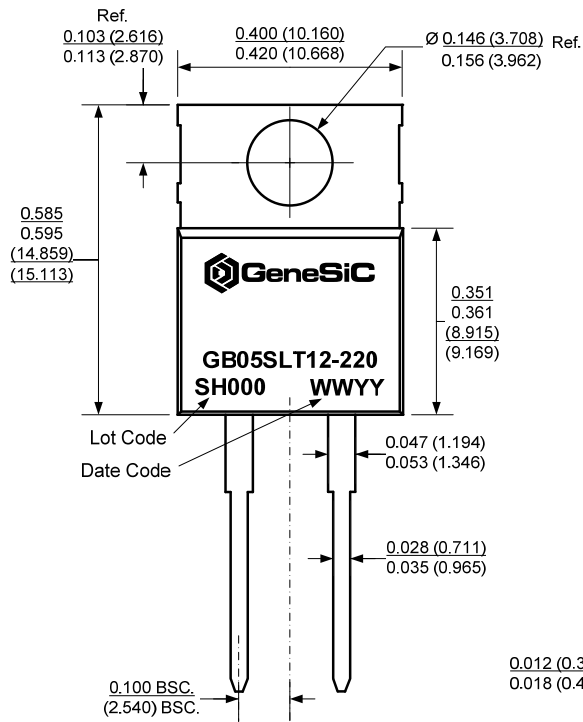

Figure 8: Transient Thermal Impedance

**Package Dimensions:**

**TO-220AC**

**PACKAGE OUTLINE**



**NOTE**

1. CONTROLLED DIMENSION IS INCH. DIMENSION IN BRACKET IS MILLIMETER.
2. DIMENSIONS DO NOT INCLUDE END FLASH, MOLD FLASH, MATERIAL PROTRUSIONS

**Revision History**

Date	Revision	Comments	Supersedes
2014/08/26	3	Updated Electrical Characteristics	
2013/02/05	2	Second generation update	
2012/05/22	1	Second generation release	
2010/12/14	0	Initial release	

Published by

GeneSiC Semiconductor, Inc.  
43670 Trade Center Place Suite 155  
Dulles, VA 20166

GeneSiC Semiconductor, Inc. reserves right to make changes to the product specifications and data in this document without notice.

GeneSiC disclaims all and any warranty and liability arising out of use or application of any product. No license, express or implied to any intellectual property rights is granted by this document.

Unless otherwise expressly indicated, GeneSiC products are not designed, tested or authorized for use in life-saving, medical, aircraft navigation, communication, air traffic control and weapons systems, nor in applications where their failure may result in death, personal injury and/or property damage.

## SPICE Model Parameters

Copy the following code into a SPICE software program for simulation of the GB05SLT12-220 device.

```
*      MODEL OF GeneSiC Semiconductor Inc.
*
*      $Revision:   1.0           $
*      $Date:      04-SEP-2013   $
*
*      GeneSiC Semiconductor Inc.
*      43670 Trade Center Place Ste. 155
*      Dulles, VA 20166
*      http://www.genesicsemi.com/index.php/sic-products/schottky
*
*      COPYRIGHT (C) 2013 GeneSiC Semiconductor Inc.
*      ALL RIGHTS RESERVED
*
*      These models are provided "AS IS, WHERE IS, AND WITH NO WARRANTY
*      OF ANY KIND EITHER EXPRESSED OR IMPLIED, INCLUDING BUT NOT LIMITED
*      TO ANY IMPLIED WARRANTIES OF MERCHANTABILITY AND FITNESS FOR A
*      PARTICULAR PURPOSE."
*      Models accurate up to 2 times rated drain current.
*
*      Start of GB05SLT12-220 SPICE Model
*
.SUBCKT GB05SLT12 ANODE KATHODE
R1 ANODE INT R=((TEMP-24)*0.0015); Temperature Dependant Resistor
D1 INT KATHODE GB05SLT12_25C; Call the 25C Diode Model
D2 ANODE KATHODE GB05SLT12_PIN; Call the PiN Diode Model
.MODEL GB05SLT12_25C D
+ IS      5.83E-18      RS      0.1276
+ N       1            IKF     602
+ EG      1.2          XTI     3
+ CJO     3.00E-10     VJ     0.419
+ M       1.6          FC     0.5
+ TT      1.00E-10     BV     1200
+ IBV     1.00E-03     VPK     1200
+ IAVE    5            TYPE    SiC_Schottky
+ MFG     GeneSiC_Semiconductor
.MODEL GB05SLT12_PIN D
+ IS      3.50 E-12     RS      0.3648
+ N       4.409        IKF     73
+ EG      3.23         XTI     -6
+ FC      0.5          TT     0
+ BV     1200          IBV     1.00E-03
+ VPK    1200          IAVE    1
+ TYPE    SiC_PiN
.ENDS
*
*      End of GB05SLT12-220 SPICE Model
```

## X-ON Electronics

Largest Supplier of Electrical and Electronic Components

*Click to view similar products for [Schottky Diodes & Rectifiers](#) category:*

*Click to view products by [GeneSiC Semiconductor](#) manufacturer:*

Other Similar products are found below :

[MA4E2039](#) [D1FH3-5063](#) [MBR0530L-TP](#) [MBR10100CT-BP](#) [MBR1545CT](#) [MMBD301M3T5G](#) [RB160M-50TR](#) [RB551V-30](#)  
[BAS16E6433HTMA1](#) [BAT 54-02LRH E6327](#) [NSR05F40QNXT5G](#) [JANS1N6640](#) [SB07-03C-TB-H](#) [SB1003M3-TL-W](#) [SK310-T](#) [SK32A-](#)  
[LTP](#) [SK34B-TP](#) [SS3003CH-TL-E](#) [GA01SHT18](#) [CRS10I30A\(TE85L,QM](#) [MA4E2501L-1290](#) [MBRB30H30CT-1G](#) [SB007-03C-TB-E](#)  
[SK32A-TP](#) [SK33B-TP](#) [SK38B-TP](#) [NRVBM120LT1G](#) [NTE505](#) [NTSB30U100CT-1G](#) [SS15E-TP](#) [VS-6CWQ10FNHM3](#) [ACDBA1100LR-HF](#)  
[ACDBA1200-HF](#) [ACDBA140-HF](#) [ACDBA2100-HF](#) [ACDBA3100-HF](#) [CDBQC0530L-HF](#) [CDBQC0240LR-HF](#) [ACDBA260LR-HF](#)  
[ACDBA1100-HF](#) [SK310B-TP](#) [MA4E2502L-1246](#) [MA4E2502H-1246](#) [NRVBM120ET1G](#) [NSR01L30MXT5G](#) [SB560](#) [PMAD1108-LF](#)  
[SD103ATW-TP](#) [1N5819T-G](#) [PDS1040Q-13](#)