

# GE2X8MPS06D

## 650V 16A SiC Schottky MPS™ Diode



### Silicon Carbide Schottky Diode

$V_{RRM}$	=	650 V
$I_F(T_C = 156^\circ\text{C})$	=	16 A *
$Q_C$	=	40 nC *

#### Features

- Revolutionary Low Built-In Voltage ( $V_{BI}$ )
- Gen5 Thin Chip Technology for Low  $V_F$
- Superior Figure of Merit  $Q_C * V_F$
- Enhanced Surge Current Robustness
- Low Thermal Resistance
- Zero Reverse Recovery
- 100% Avalanche (UIL) Tested
- Excellent  $dV/dt$  Ruggedness

#### Package

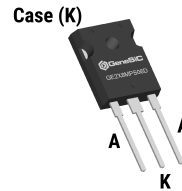

T0-247-3

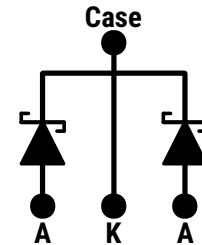

#### Advantages

- Low Conduction Losses for All Load Conditions
- Optimal Price Performance
- Increased System Power Density
- High System Reliability
- Reduced Cooling Requirements
- Temperature Independent Fast Switching
- Easy to Parallel without Thermal Runaway

#### Applications

- Switched Mode Power Supply (SMPS)
- Solar Inverter
- Server and Telecom Power Supply
- Battery Charger
- Uninterruptible Power Supply (UPS)
- Motor Control
- Power Factor Correction (PFC)

#### Absolute Maximum Ratings (At $T_C = 25^\circ\text{C}$ Unless Otherwise Stated)

Parameter	Symbol	Conditions	Values	Unit	Note
Repetitive Peak Reverse Voltage (Per Leg)	$V_{RRM}$		650	V	
Continuous Forward Current (Per Leg / Per Device)	$I_F$	$T_C = 100^\circ\text{C}, D = 1$	17 / 34	A	Fig. 4
		$T_C = 135^\circ\text{C}, D = 1$	12 / 24		
		$T_C = 156^\circ\text{C}, D = 1$	8 / 16		
Non-Repetitive Peak Forward Surge Current, Half Sine Wave (Per Leg)	$I_{F,SM}$	$T_C = 25^\circ\text{C}, t_P = 10 \text{ ms}$	56	A	
		$T_C = 150^\circ\text{C}, t_P = 10 \text{ ms}$	44		
Repetitive Peak Forward Surge Current, Half Sine Wave (Per Leg)	$I_{F,RM}$	$T_C = 25^\circ\text{C}, t_P = 10 \text{ ms}$	33	A	
		$T_C = 150^\circ\text{C}, t_P = 10 \text{ ms}$	23		
Non-Repetitive Peak Forward Surge Current (Per Leg)	$I_{F,MAX}$	$T_C = 25^\circ\text{C}, t_P = 10 \mu\text{s}$	280	A	
$i^2t$ Value (Per Leg)	$\int i^2 dt$	$T_C = 25^\circ\text{C}, t_P = 10 \text{ ms}$	15	$\text{A}^2\text{s}$	
Non-Repetitive Avalanche Energy (Per Leg)	$E_{AS}$	$L = 3.3 \text{ mH}, I_{AS} = 8 \text{ A}$	105	mJ	
Diode Ruggedness (Per Leg)	$dV/dt$	$V_R = 0 \sim 520 \text{ V}$	200	V/ns	
Power Dissipation (Per Leg / Per Device)	$P_{TOT}$	$T_C = 25^\circ\text{C}$	107 / 214	W	Fig. 3
Operating and Storage Temperature	$T_j, T_{stg}$		-55 to 175	$^\circ\text{C}$	

\* Per Device

### Electrical Characteristics (Per Leg)

Parameter	Symbol	Conditions	Values			Unit	Note
			Min.	Typ.	Max.		
Diode Forward Voltage	$V_F$	$I_F = 8\text{ A}, T_j = 25^\circ\text{C}$		1.25	1.4	V	Fig. 1
		$I_F = 8\text{ A}, T_j = 175^\circ\text{C}$		1.75			
Reverse Current	$I_R$	$V_R = 650\text{ V}, T_j = 25^\circ\text{C}$		1	10	$\mu\text{A}$	Fig. 2
		$V_R = 650\text{ V}, T_j = 175^\circ\text{C}$		155			
Total Capacitive Charge	$Q_C$	$I_F \leq I_{F,MAX}$ $di_F/dt = 200\text{ A}/\mu\text{s}$	$V_R = 200\text{ V}$		14	nC	Fig. 7
			$V_R = 400\text{ V}$		20		
Switching Time	$t_s$	$di_F/dt = 200\text{ A}/\mu\text{s}$	$V_R = 200\text{ V}$		< 10	ns	
			$V_R = 400\text{ V}$				
Total Capacitance	$C$	$V_R = 1\text{ V}, f = 1\text{ MHz}$		373		pF	Fig. 6
		$V_R = 400\text{ V}, f = 1\text{ MHz}$		26			

### Thermal/Package Characteristics

Parameter	Symbol	Conditions	Values			Unit	Note
			Min.	Typ.	Max.		
Thermal Resistance, Junction - Case (Per Leg)	$R_{thJC}$			1.41		$^\circ\text{C}/\text{W}$	Fig. 9
Weight	$W_T$			6.1		g	
Mounting Torque	$T_M$	Screws to Heatsink			1.1	Nm	

Figure 1: Typical Forward Characteristics (Per Leg)

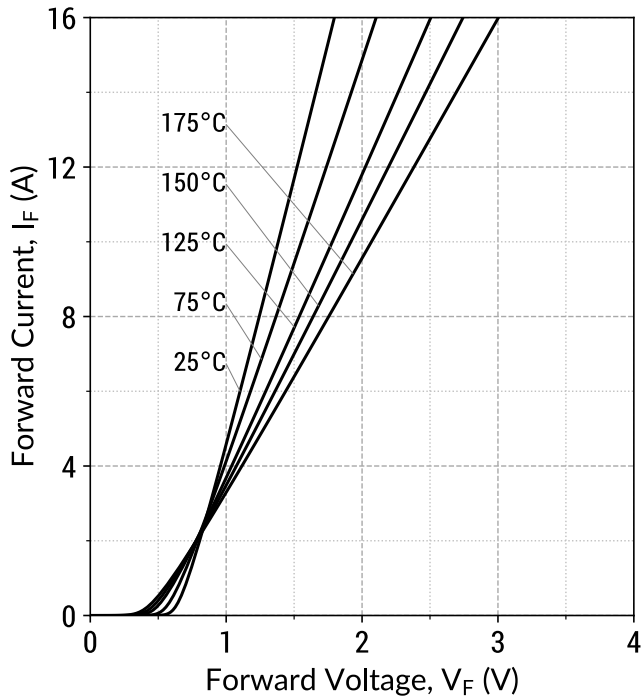

$$I_F = f(V_F, T_j); t_P = 250 \mu s$$

Figure 2: Typical Reverse Characteristics (Per Leg)

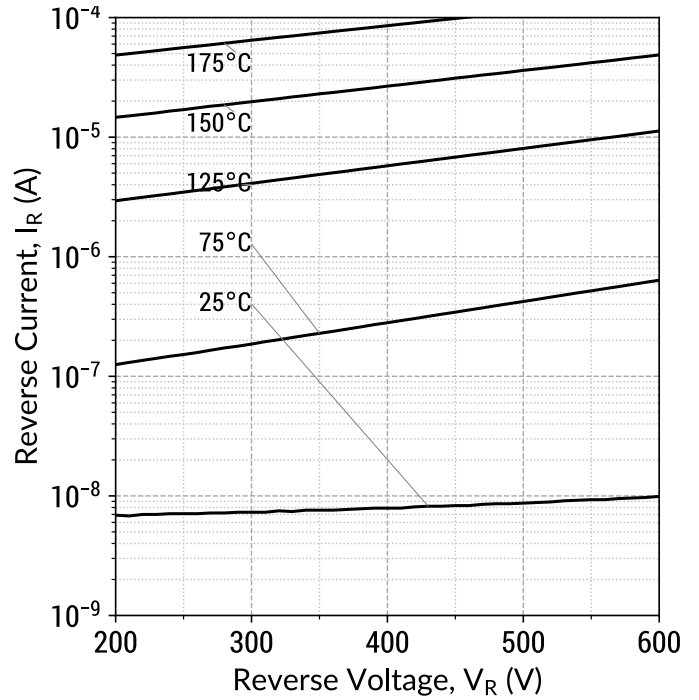

$$I_R = f(V_R, T_j)$$

Figure 3: Power Derating Curves (Per Leg)

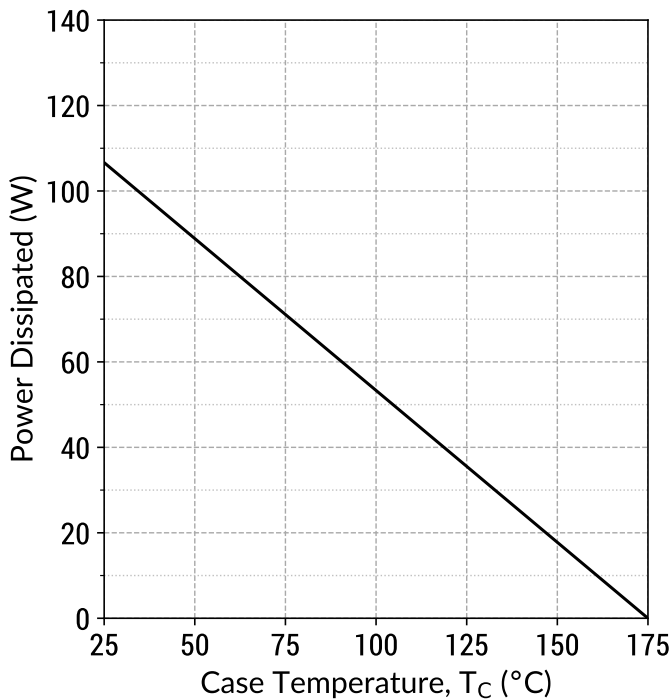

$$P_{TOT} = f(T_C); T_j = 175^\circ C$$

Figure 4: Current Derating Curves (Typical  $V_F$ ) (Per Leg)

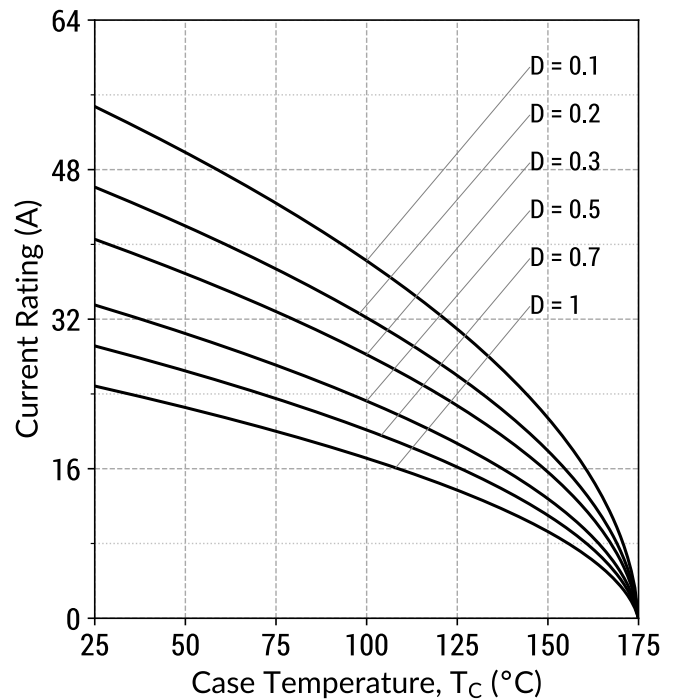

$$I_F = f(T_C); D = t_P/T; T_j \leq 175^\circ C; f_{sw} > 10 kHz$$

Figure 5: Current Derating Curves (Maximum  $V_F$ ) (Per Leg)

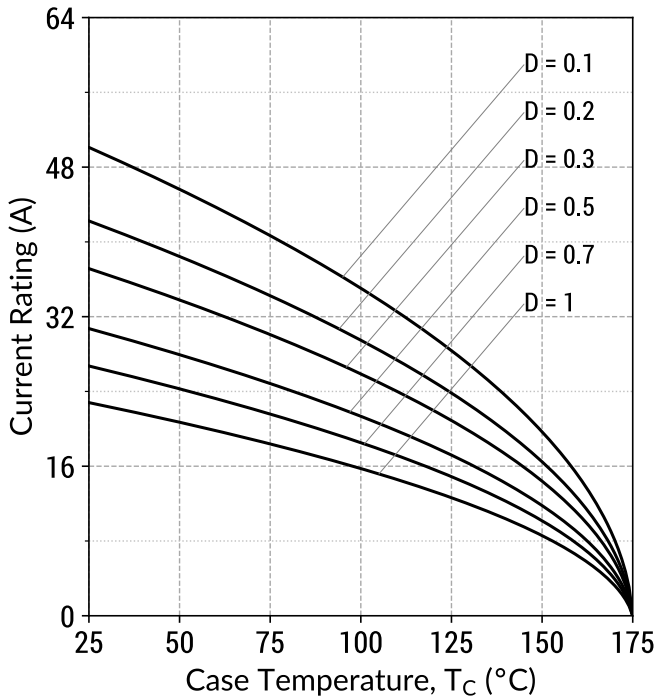

$I_F = f(T_C)$ ;  $D = t_p/T$ ;  $T_j \leq 175^\circ\text{C}$ ;  $f_{sw} > 10\text{kHz}$

Figure 6: Typical Junction Capacitance vs Reverse Voltage Characteristics (Per Leg)

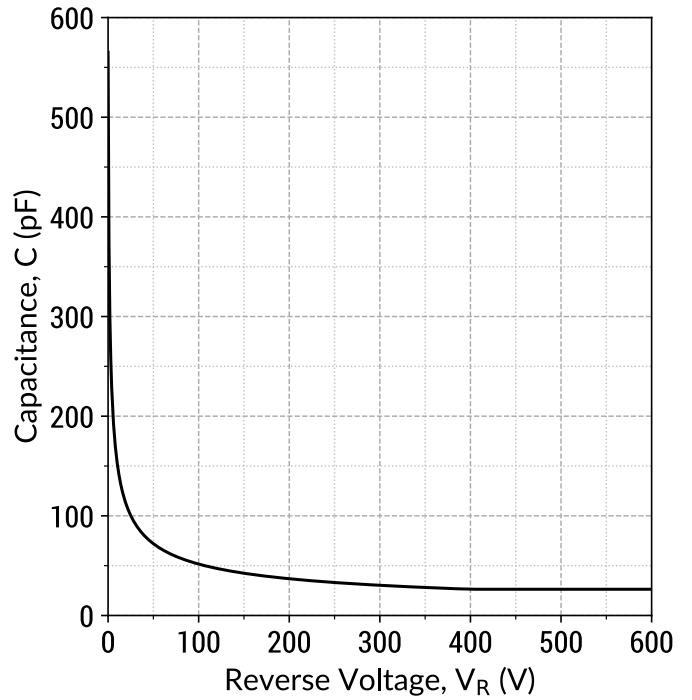

$C = f(V_R)$ ;  $f = 1\text{MHz}$

Figure 7: Typical Capacitive Charge vs Reverse Voltage Characteristics (Per Leg)

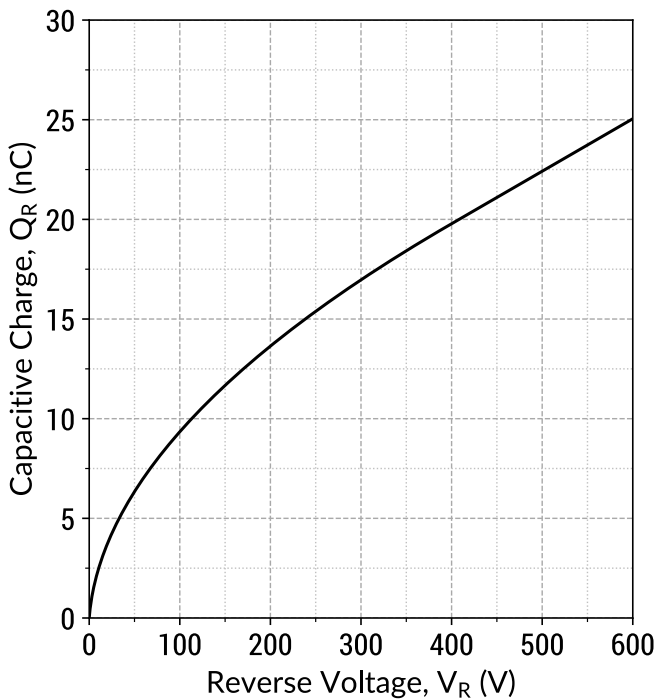

$Q_C = f(V_R)$ ;  $f = 1\text{MHz}$

Figure 8: Typical Capacitive Energy vs Reverse Voltage Characteristics (Per Leg)

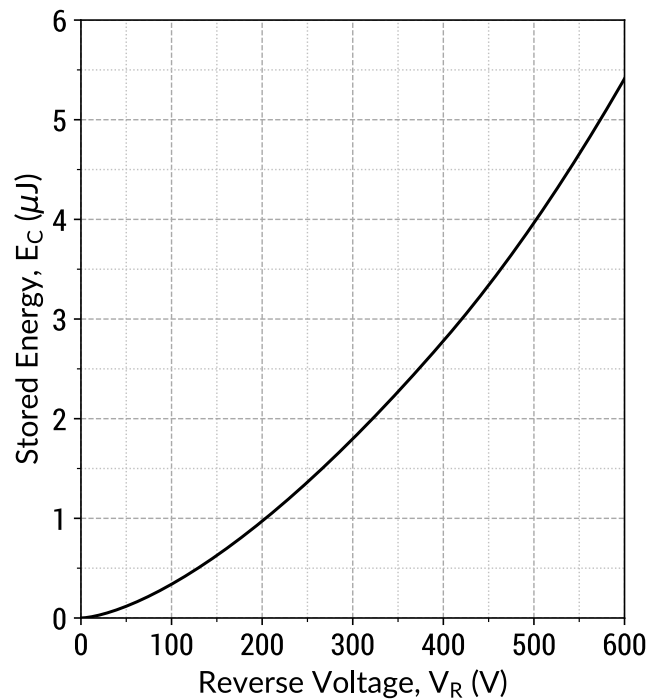

$E_C = f(V_R)$ ;  $f = 1\text{MHz}$

Figure 9: Transient Thermal Impedance (Per Leg)

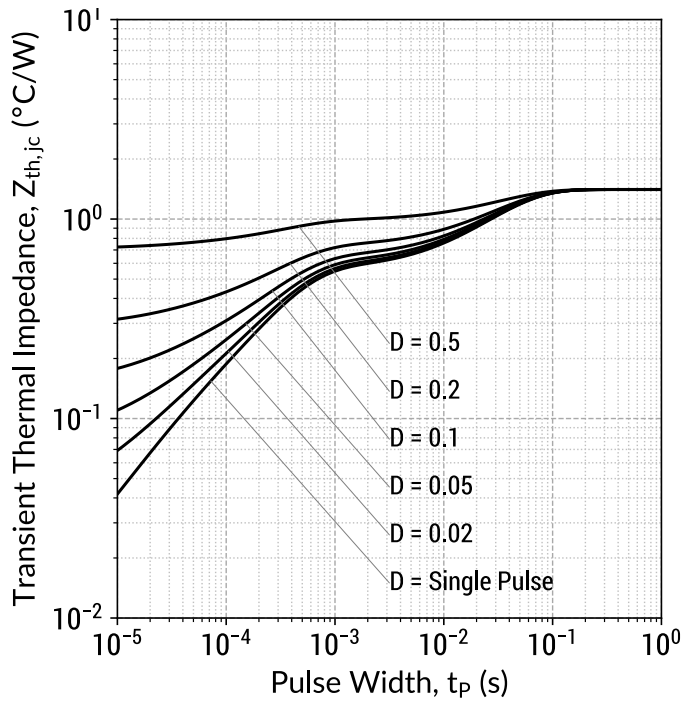

$$Z_{th,jc} = f(t_p, D); D = t_p/T$$

Figure 10: Forward Curve Model (Per Leg)

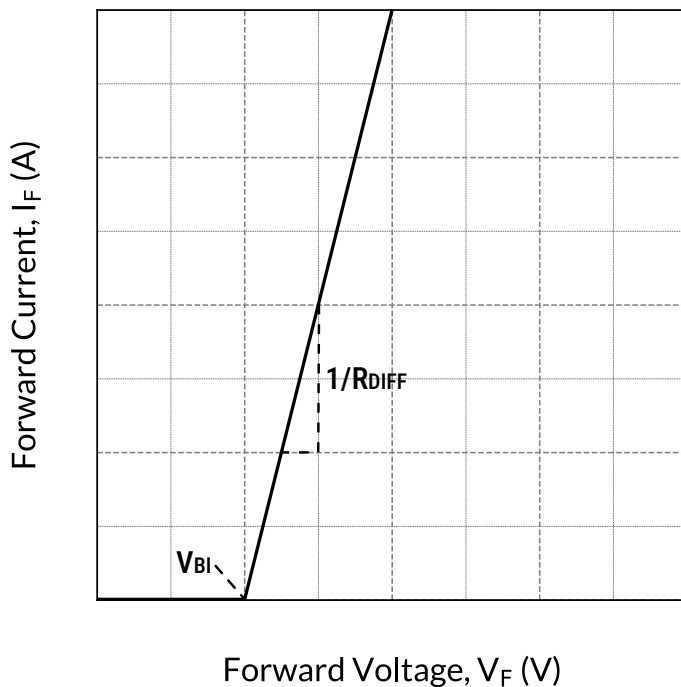

$$I_F = f(V_F, T_j)$$

**Forward Curve Model Equation:**

$$I_F = (V_F - V_{BI})/R_{DIFF} \text{ (A)}$$

**Built-In Voltage ( $V_{BI}$ ):**

$$V_{BI}(T_j) = m \times T_j + n \text{ (V)}$$

$$m = -0.00124 \text{ (V/°C)}$$

$$n = 0.72 \text{ (V)}$$

**Differential Resistance ( $R_{DIFF}$ ):**

$$R_{DIFF}(T_j) = a \times T_j^2 + b \times T_j + c \text{ (}\Omega\text{)}$$

$$a = 1.2e-06 \text{ (}\Omega\text{/°C}^2\text{)}$$

$$b = 0.000341 \text{ (}\Omega\text{/°C)}$$

$$c = 0.0602 \text{ (}\Omega\text{)}$$

**Forward Power Loss Equation:**

$$P_{LOSS} = V_{BI}(T_j) \times I_{AVG} + R_{DIFF}(T_j) \times I_{RMS}^2$$

# GE2X8MPS06D 650V 16A SiC Schottky MPS™ Diode



## Package Dimensions

### TO-247-3 Package Outline

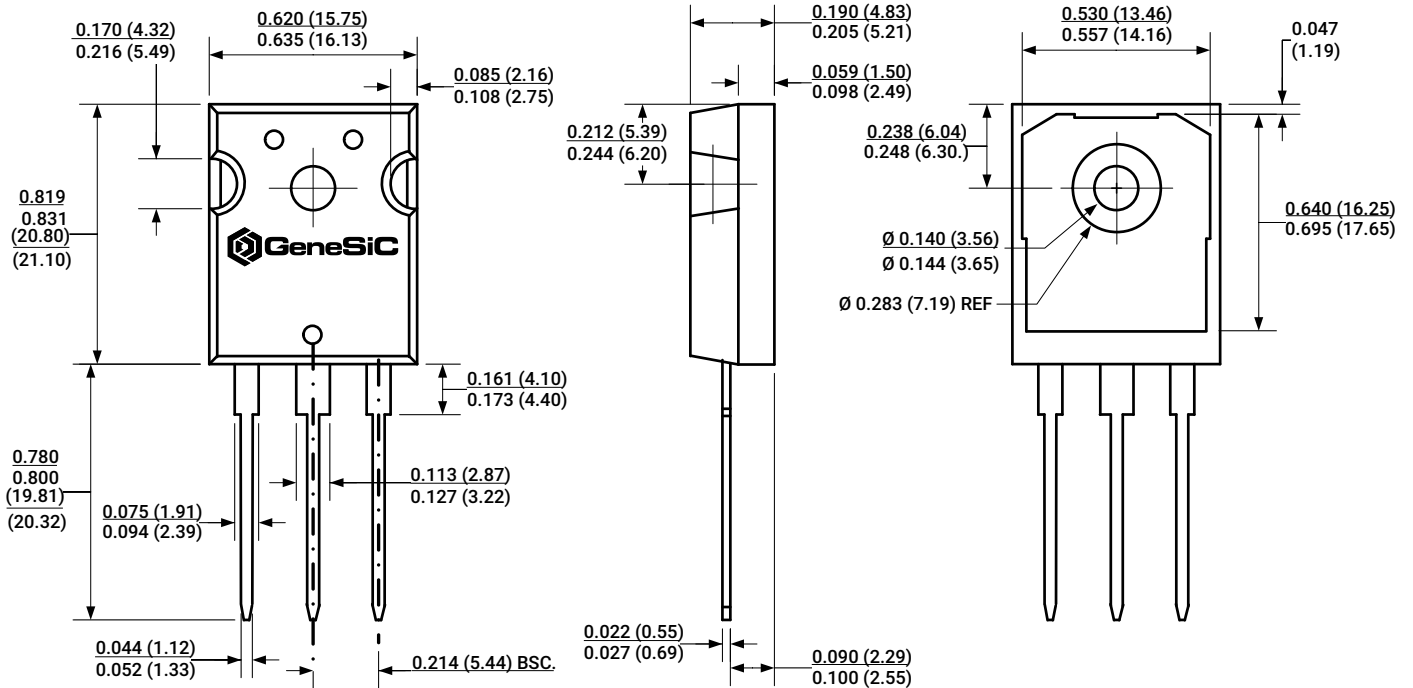

### Recommended Solder Pad Layout

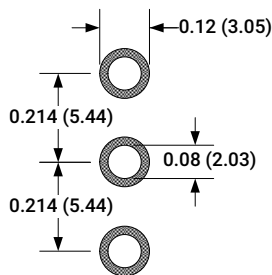

### Package View

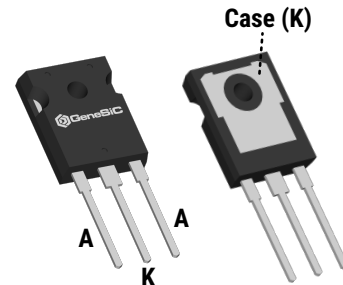

#### NOTE

1. CONTROLLED DIMENSION IS INCH. DIMENSION IN BRACKET IS MILLIMETER.
2. DIMENSIONS DO NOT INCLUDE END FLASH, MOLD FLASH, MATERIAL PROTRUSIONS.

### Compliance

#### RoHS Compliance

The levels of RoHS restricted materials in this product are below the maximum concentration values (also referred to as the threshold limits) permitted for such substances, or are used in an exempted application, in accordance with EU Directive 2011/65/EC (RoHS 2), as adopted by EU member states on January 2, 2013 and amended on March 31, 2015 by EU Directive 2015/863. RoHS Declarations for this product can be obtained from your GeneSiC representative.

#### REACH Compliance

REACH substances of high concern (SVHCs) information is available for this product. Since the European Chemical Agency (ECHA) has published notice of their intent to frequently revise the SVHC listing for the foreseeable future, please contact a GeneSiC representative to insure you get the most up-to-date REACH SVHC Declaration. REACH banned substance information (REACH Article 67) is also available upon request.

### Disclaimer

GeneSiC Semiconductor, Inc. reserves right to make changes to the product specifications and data in this document without notice. GeneSiC disclaims all and any warranty and liability arising out of use or application of any product. No license, express or implied to any intellectual property rights is granted by this document.

Unless otherwise expressly indicated, GeneSiC products are not designed, tested or authorized for use in life-saving, medical, aircraft navigation, communication, air traffic control and weapons systems, nor in applications where their failure may result in death, personal injury and/or property damage.

### Related Links

- SPICE Models: [https://www.genesicsemi.com/sic-schottky-mps/GE2X8MPS06D/GE2X8MPS06D\\_SPICE.zip](https://www.genesicsemi.com/sic-schottky-mps/GE2X8MPS06D/GE2X8MPS06D_SPICE.zip)
- PLECS Models: [https://www.genesicsemi.com/sic-schottky-mps/GE2X8MPS06D/GE2X8MPS06D\\_PLECS.zip](https://www.genesicsemi.com/sic-schottky-mps/GE2X8MPS06D/GE2X8MPS06D_PLECS.zip)
- CAD Models: [https://www.genesicsemi.com/sic-schottky-mps/GE2X8MPS06D/GE2X8MPS06D\\_3D.zip](https://www.genesicsemi.com/sic-schottky-mps/GE2X8MPS06D/GE2X8MPS06D_3D.zip)
- Evaluation Boards: <https://www.genesicsemi.com/technical-support>
- Reliability: <https://www.genesicsemi.com/reliability>
- Compliance: <https://www.genesicsemi.com/compliance>
- Quality Manual: <https://www.genesicsemi.com/quality>

### Revision History

- Rev 21/Jun: Updated with most recent test data
- Supersedes: Rev 20/Jul



[www.genesicsemi.com/sic-schottky-mps/](https://www.genesicsemi.com/sic-schottky-mps/)



## X-ON Electronics

Largest Supplier of Electrical and Electronic Components

*Click to view similar products for [Schottky Diodes & Rectifiers](#) category:*

*Click to view products by [GeneSiC Semiconductor](#) manufacturer:*

Other Similar products are found below :

[MA4E2039](#) [D1FH3-5063](#) [MBR0530L-TP](#) [MBR10100CT-BP](#) [MBR1545CT](#) [MMBD301M3T5G](#) [RB160M-50TR](#) [RB551V-30](#)  
[BAS16E6433HTMA1](#) [BAT 54-02LRH E6327](#) [NSR05F40QNXT5G](#) [JANS1N6640](#) [SB07-03C-TB-H](#) [SB1003M3-TL-W](#) [SK310-T](#) [SK32A-](#)  
[LTP](#) [SK34B-TP](#) [SS3003CH-TL-E](#) [GA01SHT18](#) [CRS10I30A\(TE85L,QM](#) [MA4E2501L-1290](#) [MBRB30H30CT-1G](#) [SB007-03C-TB-E](#)  
[SK32A-TP](#) [SK33B-TP](#) [SK38B-TP](#) [NRVBM120LT1G](#) [NTE505](#) [NTSB30U100CT-1G](#) [SS15E-TP](#) [VS-6CWQ10FNHM3](#) [ACDBA1100LR-HF](#)  
[ACDBA1200-HF](#) [ACDBA140-HF](#) [ACDBA2100-HF](#) [ACDBA3100-HF](#) [CDBQC0530L-HF](#) [CDBQC0240LR-HF](#) [ACDBA260LR-HF](#)  
[ACDBA1100-HF](#) [SK310B-TP](#) [MA4E2502L-1246](#) [MA4E2502H-1246](#) [NRVBM120ET1G](#) [NSR01L30MXT5G](#) [SB560](#) [PMAD1108-LF](#)  
[SD103ATW-TP](#) [1N5819T-G](#) [PDS1040Q-13](#)