

Single Phase Glass Passivated Silicon Bridge Rectifier

$V_{RRM} = 600\text{ V} - 1000\text{ V}$

$I_O = 25\text{ A}$

Features

- Ideal for printed circuit board
- Low forward voltage drop, high current capability
- Plastic material has Underwriters Laboratory Flammability Classification 94V-0
- Reliable, low cost construction utilizing molded
- Types from 600 V to 1000 V V_{RRM}
- Not ESD Sensitive

KBJ Package

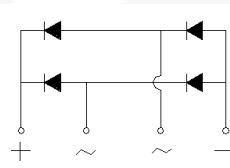

Maximum ratings at $T_a = 25\text{ }^\circ\text{C}$ (ambient temperature), unless otherwise specified

Parameter	Symbol	Conditions	KBJ2506G	KBJ2508G	KBJ2510G	Unit
Repetitive peak reverse voltage	V_{RRM}		600	800	1000	V
RMS reverse voltage	V_{RMS}		420	560	700	V
DC blocking voltage	V_{DC}		600	800	1000	V
Operating temperature	T_j		-55 to 125	-55 to 125	-55 to 125	$^\circ\text{C}$
Storage temperature	T_{stg}		-55 to 150	-55 to 150	-55 to 150	$^\circ\text{C}$

Electrical characteristics at $T_a = 25\text{ }^\circ\text{C}$, unless otherwise specified

Single phase, half sine wave, 60 Hz, resistive or inductive load
For capacitive load derate current by 20%

Parameter	Symbol	Conditions	KBJ2506G	KBJ2508G	KBJ2510G	Unit
Maximum average forward rectified current	I_O	$T_c = 110\text{ }^\circ\text{C}$	25	25	25	A
		$T_a = 25\text{ }^\circ\text{C}$	4.2	4.2	4.2	
Peak forward surge current	I_{FSM}	8.3 ms single sine-wave	350	350	350	A
Maximum instantaneous forward voltage per leg	V_F	$I_F = 12.5\text{ A}$	1.05	1.05	1.05	V
Maximum reverse current at rated DC blocking voltage per leg	I_R	$T_a = 25\text{ }^\circ\text{C}$	10	10	10	μA
		$T_a = 125\text{ }^\circ\text{C}$	500	500	500	

FIG. 1 - FORWARD CURRENT DERATING CURVE

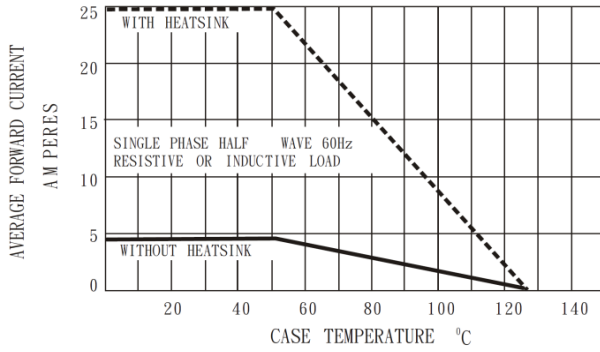

FIG. 2 - MAXIMUM NON-REPETITIVE SURGE CURRENT

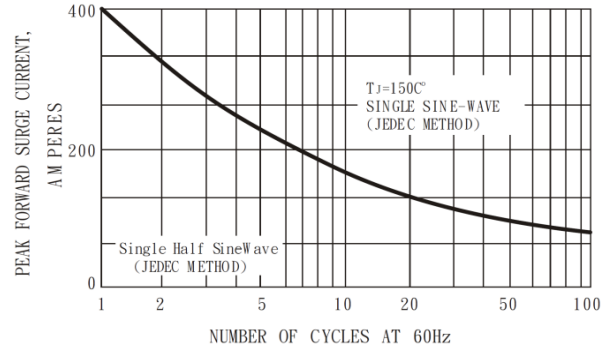

FIG. 3 - TYPICAL JUNCTION CAPACITANCE

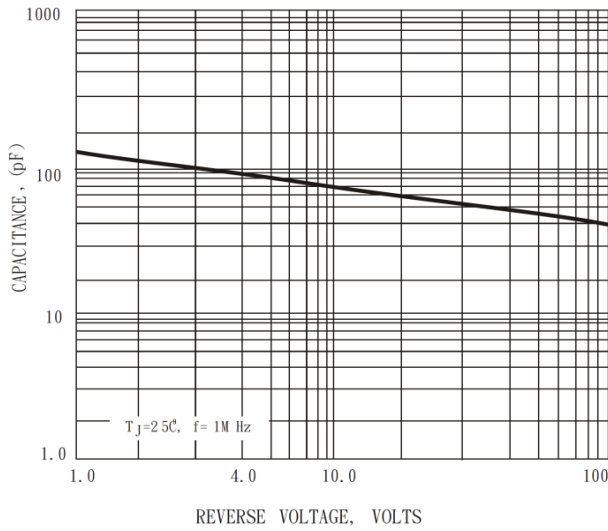

FIG. 4 - TYPICAL FORWARD CHARACTERISTICS

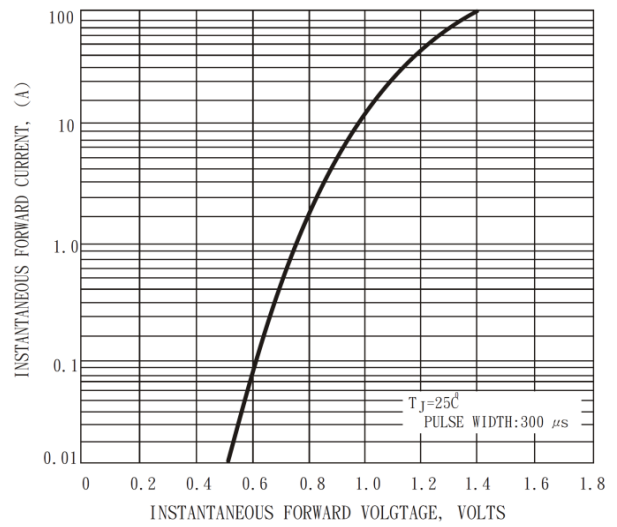
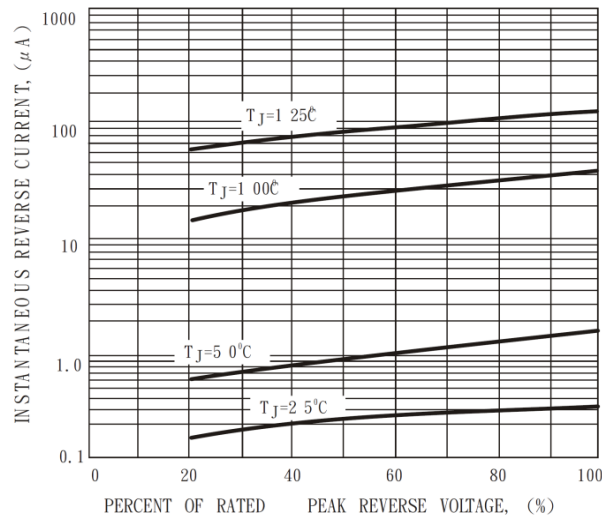
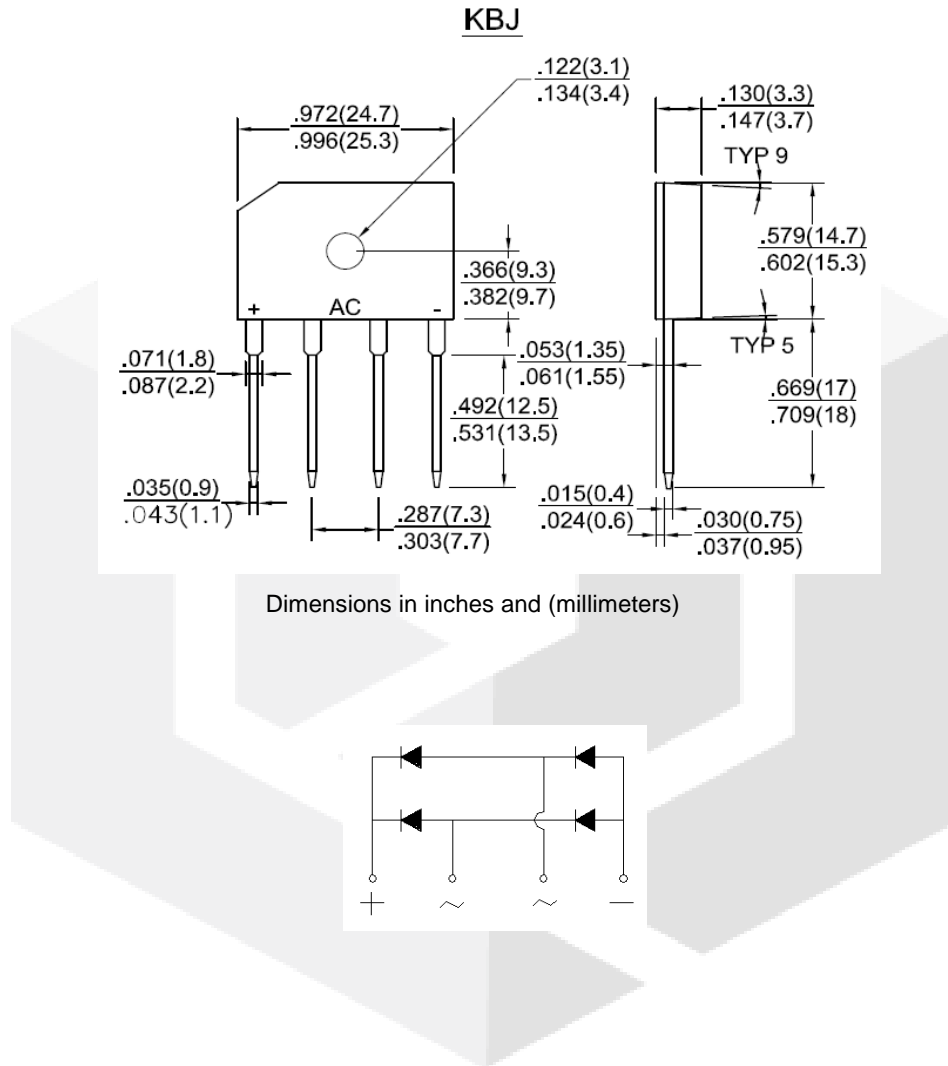

FIG. 5 - TYPICAL REVERSE CHARACTERISTICS



Package dimensions and terminal configuration

Product is marked with part number and terminal configuration.



X-ON Electronics

Largest Supplier of Electrical and Electronic Components

Click to view similar products for [Bridge Rectifiers](#) category:

Click to view products by [GeneSiC Semiconductor](#) manufacturer:

Other Similar products are found below :

[MB2510](#) [MB252](#) [MB356G](#) [MB358G](#) [GBJ1504-BP](#) [GBU15J-BP](#) [GBU15K-BP](#) [GBU4A-BP](#) [GBU6B-E3/45](#) [GSIB680-E3/45](#) [DB101-BP](#)
[DF01](#) [DF10SA-E345](#) [BU1508-E3/45](#) [KBPC50-10S](#) [RS405GL-BP](#) [G5SBA60-E3/51](#) [GBU10J-BP](#) [GBU6M](#) [GBU8D-BP](#) [GBU8J-BP](#)
[2KBB10](#) [36MB140A](#) [TB102M](#) [MB1510](#) [MB258](#) [MB6M-G](#) [MB86](#) [TL401G](#) [MDA920A2](#) [TU602](#) [TU810](#) [MP501W-BP](#) [MP502-BP](#)
[BR101-BP](#) [BR84DTP204](#) [BU2008-E3/51](#) [KBPC10/15/2501WP](#) [KBPC25-02](#) [DF06SA-E345](#) [DF1510S](#) [VS-40MT160PAPBF](#) [GBL02-E3/45](#)
[GBU4G-BP](#) [GBJ2506-BP](#) [GBU6B-E3/51](#) [GSIB15A80-E3/45](#) [DB104-BP](#) [TB354](#) [70MT160KPBF](#)