

Silicon Standard Recovery Diode

$V_{RRM} = 100\text{ V} - 600\text{ V}$

$I_F = 25\text{ A}$

Features

- High Surge Capability
- Types from 100 V to 600 V V_{RRM}
- Not ESD Sensitive

Note:

1. Standard polarity: Stud is cathode.
2. Reverse polarity (R): Stud is anode.
3. Stud is base.

DO-4 Package

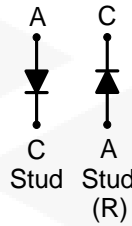

Maximum ratings, at $T_j = 25\text{ }^\circ\text{C}$, unless otherwise specified ("R" devices have leads reversed)

Parameter	Symbol	Conditions	S25B (R)	S25D (R)	S25G (R)	S25J (R)	Unit
Repetitive peak reverse voltage	V_{RRM}		100	200	400	600	V
RMS reverse voltage	V_{RMS}		70	140	280	420	V
DC blocking voltage	V_{DC}		100	200	400	600	V
Continuous forward current	I_F	$T_C \leq 120\text{ }^\circ\text{C}$	25	25	25	25	A
Surge non-repetitive forward current, Half Sine Wave	$I_{F,SM}$	$T_C = 25\text{ }^\circ\text{C}$, $t_p = 8.3\text{ ms}$	373	373	373	373	A
Operating temperature	T_j		-55 to 150	-55 to 150	-55 to 150	-55 to 150	$^\circ\text{C}$
Storage temperature	T_{stg}		-55 to 150	-55 to 150	-55 to 150	-55 to 150	$^\circ\text{C}$

Electrical characteristics, at $T_j = 25\text{ }^\circ\text{C}$, unless otherwise specified

Parameter	Symbol	Conditions	S25B (R)	S25D (R)	S25G (R)	S25J (R)	Unit
Diode forward voltage	V_F	$I_F = 25\text{ A}$, $T_j = 25\text{ }^\circ\text{C}$	1.1	1.1	1.1	1.1	V
Reverse current	I_R	$V_R = 50\text{ V}$, $T_j = 25\text{ }^\circ\text{C}$	10	10	10	10	μA
		$V_R = 50\text{ V}$, $T_j = 175\text{ }^\circ\text{C}$	12	12	12	12	mA

Thermal characteristics

Thermal resistance, junction - case	R_{thJC}		2.50	2.50	2.50	2.50	$^\circ\text{C/W}$
-------------------------------------	------------	--	------	------	------	------	--------------------

Figure .1-Typical Forward Characteristics

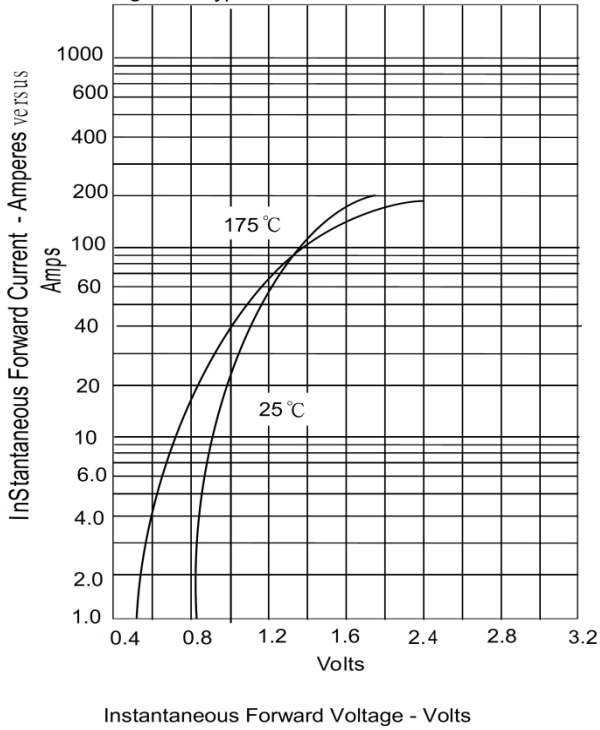

Figure .2-Forward Derating Curve

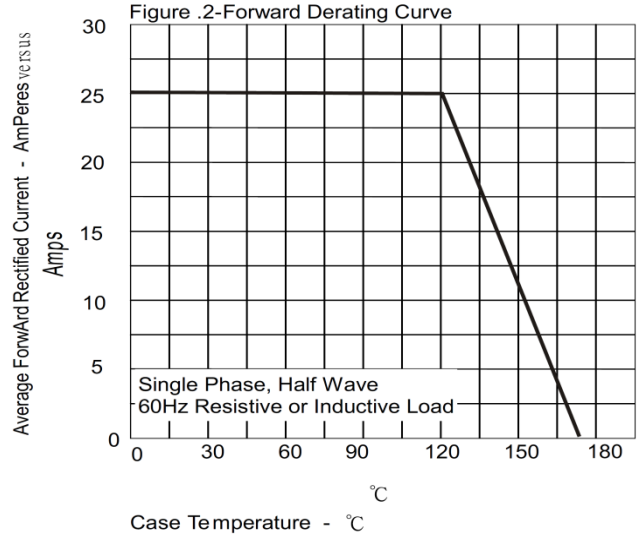

Figure .4-Typical Reverse Characteristics

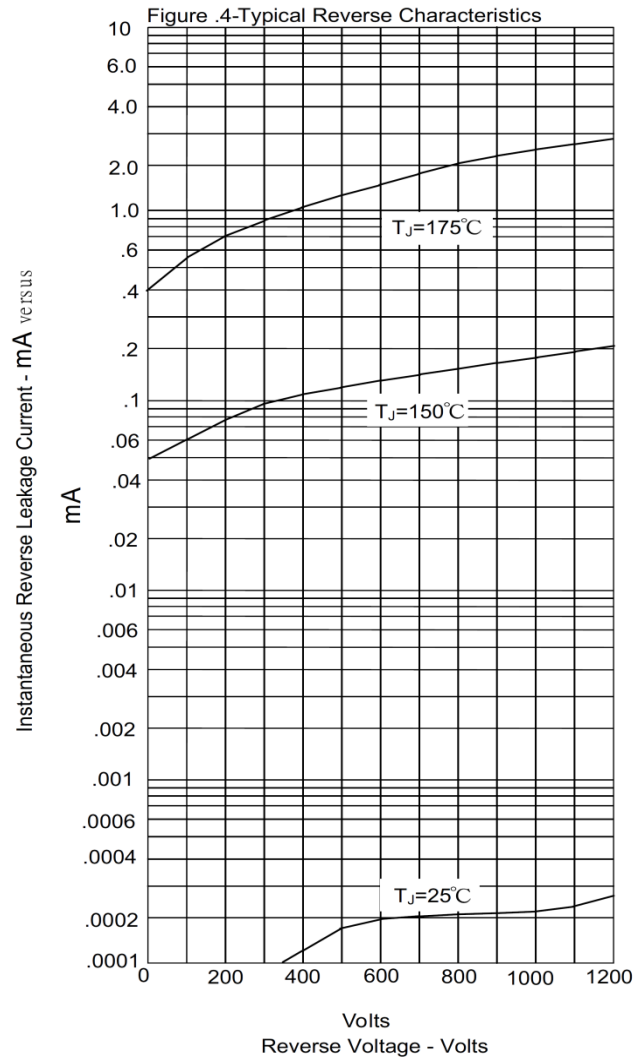
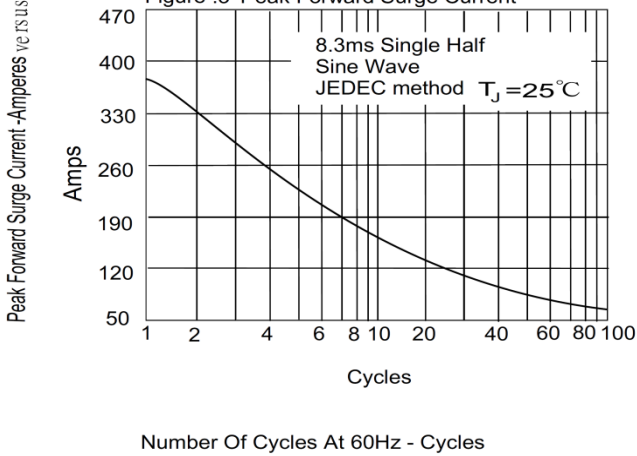
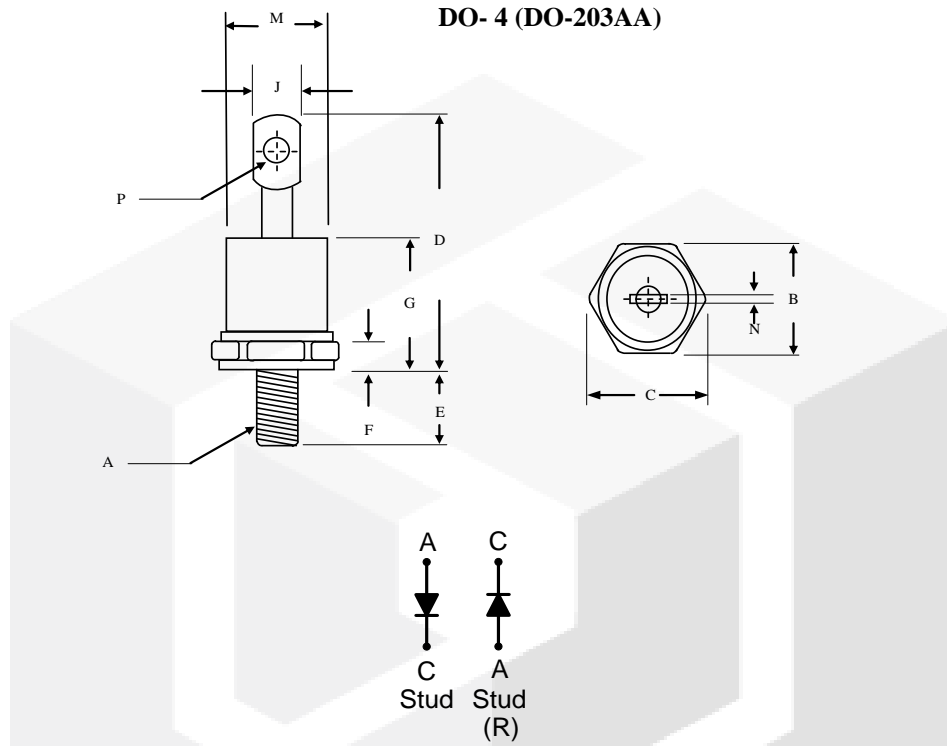

Figure .3-Peak Forward Surge Current



Package dimensions and terminal configuration

Product is marked with part number and terminal configuration.



	Inches		Millimeters	
	Min	Max	Min	Max
A	10-32 UNF			
B	0.424	0.437	10.77	11.10
C	-----	0.505	-----	12.82
D	-----	0.800	-----	20.30
E	0.453	0.492	11.50	12.50
F	0.114	0.140	2.90	3.50
G	-----	0.405	-----	10.29
J	-----	0.216	-----	5.50
M	-----	φ0.302	-----	φ7.68
N	0.031	0.045	0.80	1.15
P	0.070	0.79	1.80	2.00

X-ON Electronics

Largest Supplier of Electrical and Electronic Components

Click to view similar products for [Rectifiers](#) category:

Click to view products by [GeneSiC Semiconductor](#) manufacturer:

Other Similar products are found below :

[70HFR40](#) [RL252-TP](#) [150KR30A](#) [1N5397](#) [SCF5000](#) [1N4002G](#) [1N4005-TR](#) [JANS1N6640US](#) [VS-80-7161](#) [481235F](#) [RRE02VS6SGTR](#)
[067907F](#) [MS306](#) [70HF40](#) [T85HFL60S02](#) [VS-88-4031](#) [VS-66-9903](#) [US2JFL-TP](#) [A1N5404G-G](#) [ACGRA4007-HF](#) [ACGRB207-HF](#)
[CLH03\(Te16L,Q\)](#) [ACGRC307-HF](#) [ACEFC304-HF](#) [85HFR60](#) [40HFR60](#) [VS-88-7272PBF](#) [70HF120](#) [85HFR80](#) [D126A45C](#) [SCF7500](#)
[D251N08B](#) [SCHJ22.5K](#) [SM100](#) [SCPA2](#) [SCH10000](#) [SDHD5K](#) [VS-12FL100S10](#) [ACGRA4001-HF](#) [D1821SH45T PR](#) [D1251S45T](#)
[SKN300/16](#) [SKN 5/08](#) [TSD3G](#) [SET130312](#) [MSE07PBHM3/89A](#) [UES1106](#) [NTE6010](#) [JANTX1N5196](#) [SCHS15000](#)