



# 兆易创新选型手册 2022年版



# 关于兆易创新

北京兆易创新科技股份有限公司 (股票代码 603986) 是全球领先的 Fabless 芯片供应商,公司成立于 2005 年 4 月,总部设于中国北京,在中国上海、深圳、合肥、西安、成都、苏州、香港和台湾,美国、韩国、日本、英国、德国、新加坡等多个国家和地区均设有分支机构和办事处,营销网络遍布全球,为客户提供优质便捷的本地化支持服务。

公司的核心产品线为存储器(Flash、DRAM)、32 位通用型 MCU、智能人机交互传感器、电源产品及整体解决方案,旗下产品以“高性能、低功耗”著称,技术实力备受行业认可。

- 全球排名第一的无晶圆厂 Flash 供应商。在 NOR Flash 领域,市场占有率全球第三、中国第一,累计出货量超 190 亿颗,年出货量超 28 亿颗
- 中国品牌排名第一的 Arm® 通用型 MCU 供应商,提供超过 35 个系列、400 余款型号选择,累计出货量超 8 亿颗。
- 触控芯片全球市场排名第四;指纹芯片全球市场排名第三、中国排名第二

公司在质量管理方面有严格的标准与要求,已获得 ISO9001、ISO14001 等国际质量体系认证,同时积极推进产业整合,与全球多家领先晶圆厂、封装测试厂达成战略合作伙伴关系。未来公司将进一步围绕“感-存-算-控-联”积极布局,致力于推动 Edge 端智能化,并通过加强产业上下游合作、优化供应链管理,共同推进半导体领域的技术创新和产业升级。

## Contents

01 / GD32 MCU

20 / PMU

24 / Flash

42 / Sensor

44 / DRAM

# GD32 MCU

arm CORTEX

arm Community

arm University Program

RISC-V

R.A 中国开放指令生态 (RISC-V) 联盟  
China RISC-V Alliance

CRVIC 中国RISC-V产业联盟  
China RISC-V Industry Consortium

## GD32 MCU 型号家族

Performance	Arm® Cortex®-M 32-bit MCUs				RISC-V 32-bit MCUs	
	Cortex®-M23	Cortex®-M3	Cortex®-M4		Cortex®-M33	RISC-V
High-Performance		GD32F207 120MHz, 3M/256K  GD32F205 120MHz, 3M/256K	GD32F470 240MHz, 3M/768K  GD32F427 200MHz, 3M/256K  GD32F425 200MHz, 3M/256K	GD32F450 200MHz, 3M/512K  GD32F407 168MHz, 3M/192K  GD32F405 168MHz, 3M/192K  GD32F403 168MHz, 3M/128K	GD32W515 180MHz, 2048K/448K  GD32E508 180MHz, 512K/128K  GD32E507 180MHz, 512K/128K  GD32E505 180MHz, 512K/128K  GD32E503 180MHz, 512K/128K	
Mainstream	GD32L233 64MHz, 256K/32K	GD32F107 108MHz, 1M/96K  GD32F105 108MHz, 1M/96K  GD32F103 108MHz, 3M/96K  GD32F101 56MHz, 3M/80K	GD32F307 120MHz, 1M/96K  GD32F305 120MHz, 1M/96K  GD32F303 120MHz, 3M/96K	GD32C103 120MHz, 128K/32K  GD32E103 120MHz, 128K/32K	GD32E501 100MHz, 512K/32K	GD32VF103 108MHz, 128K/32K
Entry-Level	GD32E232 72MHz, 64K/8K  GD32E230 72MHz, 64K/8K	GD32F150 72MHz, 64K/8K  GD32F130 48MHz, 64K/8K	GD32F350 108MHz, 128K/16K  GD32F330 84MHz, 128K/16K  GD32F310 72MHz, 64K/8K			
Specific			GD32FFPR 168MHz, 1M/128K		GD32EPRT 168MHz, 384K/96K+4M	

## GD32 Cortex®-M3 MCU 200余款型号

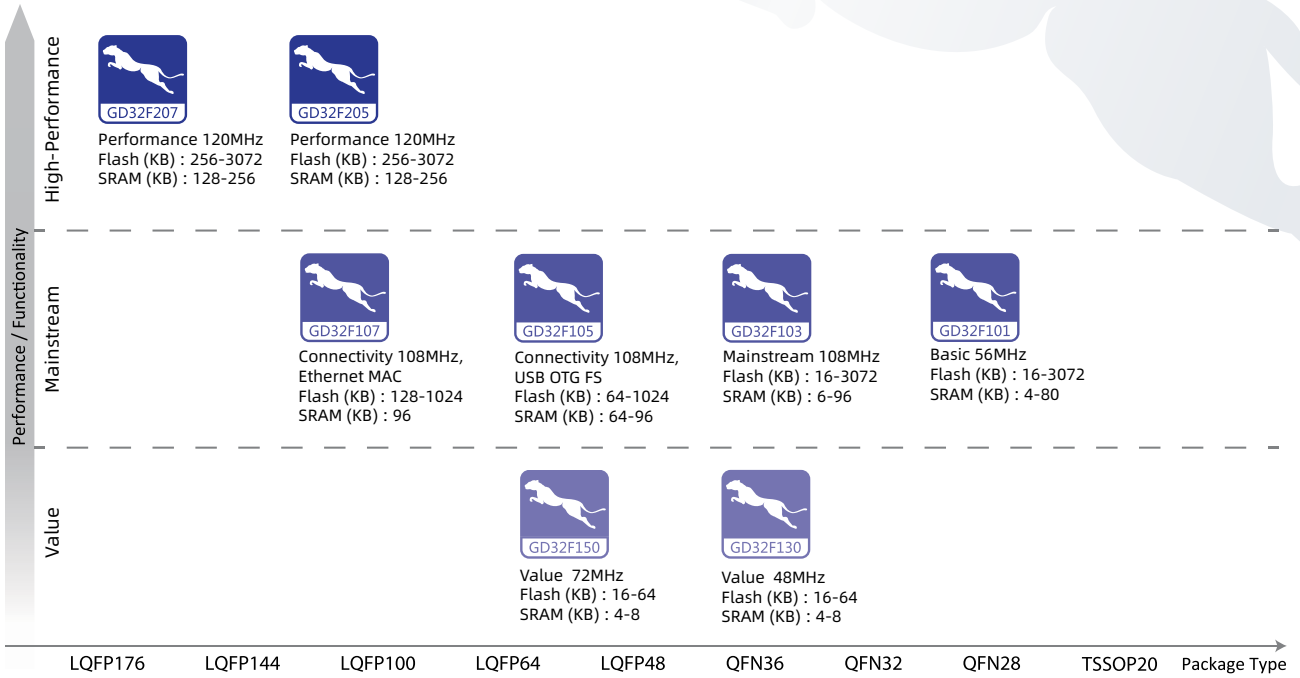

## GD32 Cortex®-M4 MCU 100余款型号

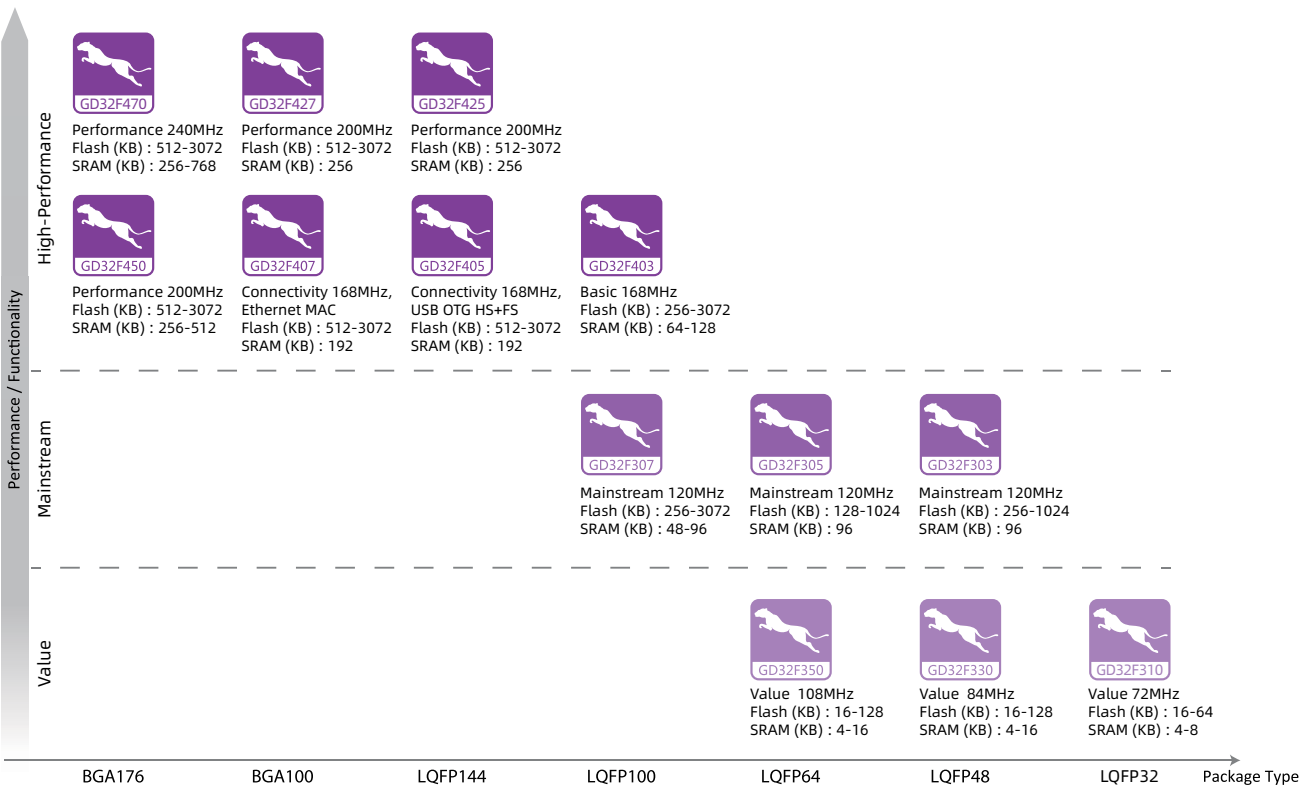

## GD32 Cortex-M23 MCU 30 余款型号

### GD32E23x 系列 MCU



- ☑ GD32E230 & GD32E232 Arm Cortex®-M23 超值型 @ 72MHz
- ☑ 16K-64K 嵌入式闪存, 4K-8K SRAM 缓存
- ☑ 1.8-3.6V 供电电压, I/O 口可承受 5V 电平
- ☑ -40°C to +85°C 工业级工作温度范围
- ☑ 各系列在硬件引脚和软件代码方面均保持相互兼容



## GD32 Cortex-M23 MCU 30 余款型号

### GD32L233 系列低功耗 MCU



- ☑ GD32L233 Arm Cortex®-M23 低功耗系列 @ 64MHz
- ☑ 64K-256K 嵌入式闪存, 16K-32K SRAM 缓存
- ☑ 1.62-3.6V 供电电压, I/O 口可承受 5V 电平
- ☑ -40°C to +85°C 工业级工作温度范围
- ☑ 各系列在硬件引脚和软件代码方面均保持相互兼容



## GD32 Cortex-M33 MCU 30 余款型号

### GD32E5 系列 MCU



- ☑ GD32E503 / 505 / 507 / 508 / PRT 高性能型
- ☑ Arm Cortex®-M33 @ 180MHz
- ☑ 128K-512K 嵌入式 eFlash, 80K-128K SRAM 缓存
- ☑ 1.7-3.6V 供电电压, I/O 口可承受 5V 电平
- ☑ -40°C to +85°C 工业级工作温度范围
- ☑ 各系列在硬件引脚和软件代码方面均保持相互兼容



## GD32 Cortex-M33 MCU 30 余款型号

### GD32W5 系列 Wi-Fi MCU



- ☑ GD32W515 Arm Cortex®-M33 无线系列 @180MHz
- ☑ 0-2048K 片上闪存, 384K-448K SRAM 缓存
- ☑ 1.62-3.63V 供电电压, I/O 口可承受 5V 电平
- ☑ -40°C to +85°C 工业级工作温度范围
- ☑ 各系列在硬件引脚和软件代码方面均保持相互兼容

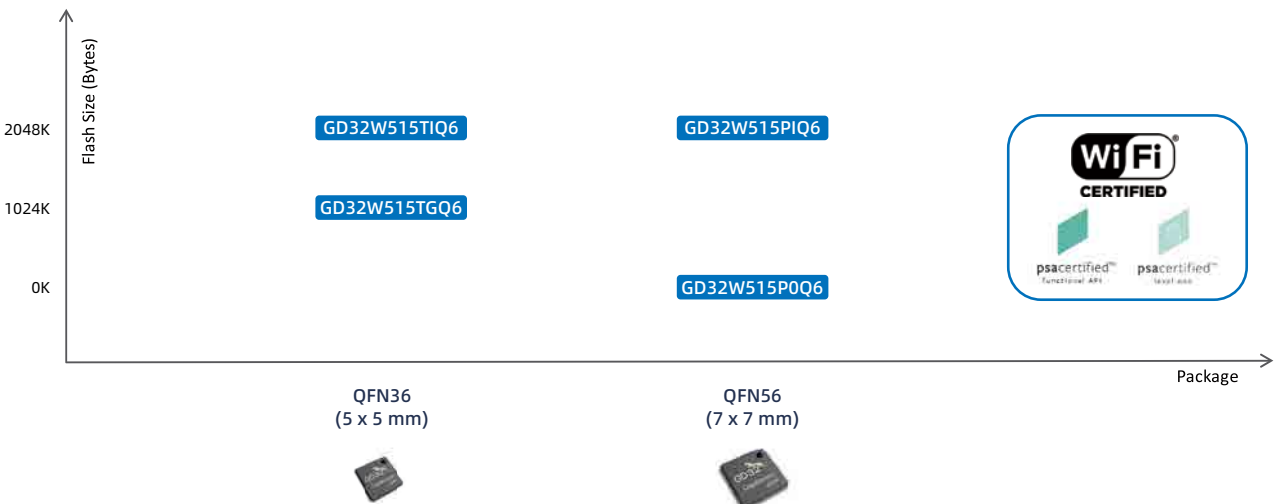

# GD32VF103 RISC-V MCU 14 款型号



- ☑ GD32VF103 RISC-V Bumblebee内核主流型
- ☑ 高达108MHz的运算主频，16K-128K片上闪存，6K-32K SRAM缓存
- ☑ 2.6-3.6V供电电压，I/O口可承受5V电平，所有型号均支持USB OTG和CAN 2.0B
- ☑ -40°C to +85°C 工业级工作温度范围
- ☑ 各系列在硬件引脚和软件代码方面均保持相互兼容



## MCU 型号封装形式

LQFP176 (24*24mm)	LQFP144 (20*20mm)	LQFP100 (14*14mm)	LQFP64 (10*10mm)	LQFP48 (7*7mm)	LQFP32 (7*7mm)	BGA176 (10*10mm)		
BGA100 (7*7mm)	QFN56 (7*7mm)	QFN36 (6*6mm)	QFN32 (5*5mm)	QFN32 (4*4mm)	QFN28 (4*4mm)	QFN24 (3*3mm)	TSSOP20 (6.5*4.4mm)	LGA20 (3*3mm)

# GD32 生态系统



A grid of logos for various partners and technologies in the GD32 ecosystem. The logos are arranged in four rows. Row 1: arm KEIL, SEGGER, IAR SYSTEMS, Embee!le IDE, CrossWorks, PE micPO, ARM mbed enabled. Row 2: aws, Microsoft Azure, FreeRTOS, RT-Thread, TencentOS Tiny, 0x5 HEX-Flow, sensory. Row 3: Algocraft, ELNEC, SMH Technologies, 创芯工坊, XELTEK SuperBOT Automated Equipment Company, Wilson, ZLG 致远电子. Row 4: USB, WiFi CERTIFIED, psacertified, RISC-V, 芯来科技 NUCLEI, GNU MCU, GCC, Tmall 天猫 GD32官方旗舰店 GD MCUEMMCFLASHGD-LINK.

所有提及的商标版权均为其所有者所有。





# GD32W5 系列

## ARM® Cortex®-M33 内核 32 位通用 MCU



Series	Part No.	Max Speed (MHz)	Memory(Bytes)		I/O	Timer							Connectivity									Analog Interface		Package			
			Flash	SRAM		GPTM (32bit)	GPTM (16bit)	Advanced TM (16bit)	Basic TM (16bit)	SysTick (24bit)	WDG	RTC	USART	I <sup>2</sup> C	SPI	USB 2.0 FS	I <sup>2</sup> S	SD IO	IEEE 802.11	QS PI	Digital filters	Digital Camera	HW Security		12bit ADC Units (CHs)	Cap. Touch Key	
GD32W515	GD32W515TGQ6	180	1024K	384K	up to 25	2	3	1	1	1	2	1	3	2	2	OTG	1	1	b/g/n	1				•	1(5)	7	QFN36
	GD32W515TIQ6	180	2048K	448K	up to 25	2	3	1	1	1	2	1	3	2	2	OTG	1	1	b/g/n	1				•	1(5)	7	QFN36
	GD32W515P0Q6	180	0K	448K	up to 43	2	4	1	1	1	2	1	3	2	2	OTG	1	1	b/g/n	1	•	•	•	•	1(9)	12	QFN56
	GD32W515PIQ6	180	2048K	448K	up to 43	2	4	1	1	1	2	1	3	2	2	OTG	1	1	b/g/n	1	•	•	•	•	1(9)	12	QFN56

# GD32L23x 系列

## ARM® Cortex®-M23 内核 32 位通用 MCU 选型



Series	Part No.	Max Speed (MHz)	Memory(Bytes)		I/O	Timer							Connectivity								Analog Interface		Package				
			Flash	SRAM		LPTM (32bit)	GPTM (16bit)	Advanced TM (16bit)	Basic TM (16bit)	SysTick (24bit)	WDG	RTC	USAR +UART	LP UART	I <sup>2</sup> C	SPI	USB 2.0	I <sup>2</sup> S	Comp	Segment LCD	12bit ADC Units (CHs)	12bit DAC Units					
GD32L233	GD32L233K8Q6	64	64K	16K	up to 29	1	3	0	2	1	2	1	2+1	1	2	2	FS	1	2						1(10)	1	QFN32
	GD32L233KBQ6	64	128K	24K	up to 29	1	3	0	2	1	2	1	2+1	1	2	2	FS	1	2						1(10)	1	QFN32
	GD32L233K8T6	64	64K	16K	up to 27	1	3	0	2	1	2	1	2+1	1	2	2	FS	1	2						1(10)	1	LQFP32
	GD32L233KBT6	64	128K	24K	up to 27	1	3	0	2	1	2	1	2+1	1	2	2	FS	1	2						1(10)	1	LQFP32
	GD32L233C8T6	64	64K	16K	up to 43	1	3	0	2	1	2	1	2+1	1	2	2	FS	1	2						1(10)	1	LQFP48
	GD32L233CBT6	64	128K	24K	up to 43	1	4	0	2	1	2	1	2+2	1	2	2	FS	1	2						1(10)	1	LQFP48
	GD32L233CCT6	64	256K	32K	up to 43	1	4	0	2	1	2	1	2+2	1	2	2	FS	1	2						1(10)	1	LQFP48
	GD32L233R8T6	64	64K	16K	up to 59	1	3	0	2	1	2	1	2+1	1	3	2	FS	1	2	8*28/4*32					1(16)	1	LQFP64
	GD32L233RBT6	64	128K	24K	up to 59	1	4	0	2	1	2	1	2+2	1	3	2	FS	1	2	8*28/4*32					1(16)	1	LQFP64
	GD32L233RCT6	64	256K	32K	up to 59	1	4	0	2	1	2	1	2+2	1	3	2	FS	1	2	8*28/4*32					1(16)	1	LQFP64

# GD32E5 系列

## ARM® Cortex®-M33 内核 32 位通用 MCU 选型



Series	Part No.	Max Speed (MHz)	Memory (Bytes)		I/O	Timer							Connectivity										Analog Interface		Package						
			Flash	SRAM		GPTM (32bit)	GPTM (16bit)	Advanced TM (16bit)	Bsc TM (16bit)	SysTick (24bit)	WDG	RTC	USART+UART	I <sup>2</sup> C	SPI	CAN 2.0B	USB 2.0	I <sup>2</sup> S	SD IO	Ether-net	TMU	SH RTM	Co mp	EX MC		12bit ADC Units (CHs)	12bit DAC Units				
GD32E503	GD32E503CCT6	180	256K	96K	up to 37	1	3	1	2	1	2	1	3+0	3	3	2	FS	2											3(10)	2	LQFP48
	GD32E503CET6	180	512K	128K	up to 37	1	9	1	2	1	2	1	3+0	3	3	2	FS	2											3(10)	2	LQFP48
	GD32E503RCT6	180	256K	96K	up to 51	1	3	2	2	1	2	1	4+2	3	3	2	FS	2	1										3(16)	2	LQFP64
	GD32E503RET6	180	512K	128K	up to 51	1	9	2	2	1	2	1	4+2	3	3	2	FS	2	1										3(16)	2	LQFP64
	GD32E503VCT6	180	256K	96K	up to 80	1	3	2	2	1	2	1	4+2	3	3	2	FS	2	1										3(16)	2	LQFP100
	GD32E503VET6	180	512K	128K	up to 80	1	9	2	2	1	2	1	4+2	3	3	2	FS	2	1										3(16)	2	LQFP100
	GD32E503ZCT6	180	256K	96K	up to 112	1	3	2	2	1	2	1	4+2	3	3	2	FS	2	1										3(21)	2	LQFP144
GD32E503ZET6	180	512K	128K	up to 112	1	9	2	2	1	2	1	4+2	3	3	2	FS	2	1										3(21)	2	LQFP144	
GD32E505	GD32E505RBT6	180	128K	80K	up to 51	1	3	1	2	1	2	1	4+2	3	3	3	HS OTG	2											2(16)	2	LQFP64
	GD32E505RCT6	180	256K	96K	up to 51	1	3	1	2	1	2	1	4+2	3	3	3	HS OTG	2											2(16)	2	LQFP64
	GD32E505RET6	180	512K	128K	up to 51	1	9	2	2	1	2	1	4+2	3	3	3	HS OTG	2											2(16)	2	LQFP64
	GD32E505VCT6	180	256K	96K	up to 80	1	3	1	2	1	2	1	4+2	3	3	3	HS OTG	2											2(16)	2	LQFP100
	GD32E505VET6	180	512K	128K	up to 80	1	9	2	2	1	2	1	4+2	3	3	3	HS OTG	2											2(16)	2	LQFP100
	GD32E505ZCT6	180	256K	96K	up to 112	1	3	2	2	1	2	1	4+2	3	3	3	HS OTG	2											2(16)	2	LQFP144
	GD32E505ZET6	180	512K	128K	up to 112	1	9	2	2	1	2	1	4+2	3	3	3	HS OTG	2											2(16)	2	LQFP144
GD32E507	GD32E507RCT6	180	256K	96K	up to 51	1	3	1	2	1	2	1	4+2	3	3	3	HS OTG	2											2(16)	2	LQFP64
	GD32E507RET6	180	512K	128K	up to 51	1	9	2	2	1	2	1	4+2	3	3	3	HS OTG	2											2(16)	2	LQFP64
	GD32E507VCT6	180	256K	96K	up to 80	1	3	1	2	1	2	1	4+2	3	3	3	HS OTG	2											2(16)	2	LQFP100
	GD32E507VET6	180	512K	128K	up to 80	1	9	2	2	1	2	1	4+2	3	3	3	HS OTG	2											2(16)	2	LQFP100
	GD32E507ZCT6	180	256K	96K	up to 112	1	3	2	2	1	2	1	4+2	3	3	3	HS OTG	2											2(16)	2	LQFP144
	GD32E507ZET6	180	512K	128K	up to 112	1	9	2	2	1	2	1	4+2	3	3	3	HS OTG	2											2(16)	2	LQFP144
GD32E508	GD32E508RET6	180	512K	128K	up to 51	1	9	2	2	1	2	1	4+2	3	3	3xFD	HS OTG	2											2(16)	2	LQFP64
	GD32E508VET6	180	512K	128K	up to 80	1	9	2	2	1	2	1	4+2	3	3	3xFD	HS OTG	2											2(16)	2	LQFP100
	GD32E508ZET6	180	512K	128K	up to 112	1	9	2	2	1	2	1	4+2	3	3	3xFD	HS OTG	2											2(16)	2	LQFP144
GD32EPRT	GD32EPRTD6	180	384K	96K+4MB PSRAM	up to 51	1	3	2	2	1	2	1	3+3	3	3		FS	2											3(16)	2	LQFP64
	GD32EPRTVDT6	180	384K	96K+4MB PSRAM	up to 80	1	3	2	2	1	2	1	3+3	3	3		FS	2											3(16)	2	LQFP100

## GD32V 系列 RISC-V 内核 32 位通用 MCU 选型



Series	Part No.	Max Speed (MHz)	Memory (Bytes)		I/O	Timer						Connectivity							EXMC	Analog Interface		Package	
			Flash	SRAM		GPTM (16bit)	Advanced TM (16bit)	Basic TM (16bit)	SysTick (24bit)	WDG	RTC	USART +UART	I <sup>2</sup> C	SPI	CAN 2.0B	USB 2.0 FS	I <sup>2</sup> S	SDIO		Ether-net	12bit ADC Units (CHs)		12bit DAC Units
GD32VF103	GD32VF103T4U6	108	16K	6K	up to 26	2	1	2	1	2	1	2+0	1	1	2	OTG					2(10)	2	QFN36
	GD32VF103T6U6	108	32K	10K	up to 26	2	1	2	1	2	1	2+0	1	1	2	OTG					2(10)	2	QFN36
	GD32VF103T8U6	108	64K	20K	up to 26	4	1	2	1	2	1	2+0	1	1	2	OTG					2(10)	2	QFN36
	GD32VF103TBU6	108	128K	32K	up to 26	4	1	2	1	2	1	2+0	1	1	2	OTG					2(10)	2	QFN36
	GD32VF103C4T6	108	16K	6K	up to 37	2	1	2	1	2	1	2+0	1	1	2	OTG					2(10)	2	LQFP48
	GD32VF103C6T6	108	32K	10K	up to 37	2	1	2	1	2	1	2+0	1	1	2	OTG					2(10)	2	LQFP48
	GD32VF103C8T6	108	64K	20K	up to 37	4	1	2	1	2	1	3+0	2	3	2	OTG	2				2(10)	2	LQFP48
	GD32VF103CBT6	108	128K	32K	up to 37	4	1	2	1	2	1	3+0	2	3	2	OTG	2				2(10)	2	LQFP48
	GD32VF103R4T6	108	16K	6K	up to 51	2	1	2	1	2	1	2+0	1	1	2	OTG					2(16)	2	LQFP64
	GD32VF103R6T6	108	32K	10K	up to 51	2	1	2	1	2	1	2+0	1	1	2	OTG					2(16)	2	LQFP64
	GD32VF103R8T6	108	64K	20K	up to 51	4	1	2	1	2	1	3+2	2	3	2	OTG	2				2(16)	2	LQFP64
	GD32VF103RBT6	108	128K	32K	up to 51	4	1	2	1	2	1	3+2	2	3	2	OTG	2				2(16)	2	LQFP64
	GD32VF103V8T6	108	64K	20K	up to 80	4	1	2	1	2	1	3+2	2	3	2	OTG	2			•	2(16)	2	LQFP100
GD32VF103VBT6	108	128K	32K	up to 80	4	1	2	1	2	1	3+2	2	3	2	OTG	2			•	2(16)	2	LQFP100	

## GD32E23x 系列 ARM® Cortex®-M23 内核 32 位通用 MCU 选型



Series	Part No.	Max Speed (MHz)	Memory (Bytes)		I/O	Timer						Connectivity							Analog Interface		Package		
			Flash	SRAM		GPTM (32bit)	GPTM (16bit)	Advanced TM (16bit)	Basic TM (16bit)	SysTick (24bit)	WDG	RTC	USART	I <sup>2</sup> C	SPI	USB 2.0 FS	I <sup>2</sup> S	Comp	OP-AMP	12bit ADC Units (CHs)		12bit DAC Units	
GD32E230	GD32E230F4P6	72	16K	4K	up to 15		4	1	1	1	2	1	1	1	1		1	1			1(9)		TSSOP20
	GD32E230F6P6	72	32K	6K	up to 15		4	1	1	1	2	1	2	1	1		1	1			1(9)		TSSOP20
	GD32E230F8P6	72	64K	8K	up to 15		4	1	1	1	2	1	2	2	2		1	1			1(9)		TSSOP20
	GD32E230F4V6	72	16K	4K	up to 15		4	1	1	1	2	1	1	1	1		1	1			1(9)		LGA20
	GD32E230F6V6	72	32K	6K	up to 15		4	1	1	1	2	1	2	1	1		1	1			1(9)		LGA20
	GD32E230F8V6	72	64K	8K	up to 15		4	1	1	1	2	1	2	2	2		1	1			1(9)		LGA20
	GD32E230G4U6	72	16K	4K	up to 23		4	1	1	1	2	1	1	1	1		1	1			1(10)		QFN28
	GD32E230G6U6	72	32K	6K	up to 23		4	1	1	1	2	1	2	1	1		1	1			1(10)		QFN28
	GD32E230G8U6	72	64K	8K	up to 23		5	1	1	1	2	1	2	2	2		1	1			1(10)		QFN28
	GD32E230K4U6	72	16K	4K	up to 27		4	1	1	1	2	1	1	1	1		1	1			1(10)		QFN32
	GD32E230K6U6	72	32K	6K	up to 27		4	1	1	1	2	1	2	1	1		1	1			1(10)		QFN32
	GD32E230K8U6	72	64K	8K	up to 27		5	1	1	1	2	1	2	2	2		1	1			1(10)		QFN32
	GD32E230K4T6	72	16K	4K	up to 25		4	1	1	1	2	1	1	1	1		1	1			1(10)		LQFP32

## GD32E23x 系列 ARM® Cortex®-M23 内核 32 位通用 MCU 选型



Series	Part No.	Max Speed (MHz)	Memory (Bytes)		I/O	Timer							Connectivity							Analog Interface		Package	
			Flash	SRAM		GPTM (32bit)	GPTM (16bit)	Advanced TM (16bit)	Basic TM (16bit)	SysTick (24bit)	WDG	RTC	USART	I <sup>2</sup> C	SPI	USB 2.0 FS	I <sup>2</sup> S	Comp	OP-AMP	12bit ADC Units (CHs)	12bit DAC Units		
GD32E230	GD32E230K6T6	72	32K	6K	up to 25		4	1	1	1	2	1	2	1	1		1	1			1(10)		LQFP32
	GD32E230K8T6	72	64K	8K	up to 25		5	1	1	1	2	1	2	2	2		1	1			1(10)		LQFP32
	GD32E230C4T6	72	16K	4K	up to 39		4	1	1	1	2	1	1	1	1		1	1			1(10)		LQFP48
	GD32E230C6T6	72	32K	6K	up to 39		4	1	1	1	2	1	2	1	1		1	1			1(10)		LQFP48
	GD32E230C8T6	72	64K	8K	up to 39		5	1	1	1	2	1	2	2	2		1	1			1(10)		LQFP48
GD32E232	GD32E232E4U7	72	16K	4K	up to 18	1	4	1	2	1	2	1	2	2	1		1				1(9)	4	QFN24
	GD32E232E6U7	72	32K	6K	up to 18	1	4	1	2	1	2	1	2	2	1		1				1(9)	4	QFN24
	GD32E232E8U7	72	64K	8K	up to 18	1	5	1	2	1	2	1	2	2	2		1				1(9)	4	QFN24
	GD32E232K4Q7	72	16K	4K	up to 28	1	4	1	2	1	2	1	2	2	1		1				1(16)	4	QFN32
	GD32E232K6Q7	72	32K	6K	up to 28	1	4	1	2	1	2	1	2	2	1		1				1(16)	4	QFN32
	GD32E232K8Q7	72	64K	8K	up to 28	1	5	1	2	1	2	1	2	2	2		1				1(16)	4	QFN32

## GD32E1 系列 ARM® Cortex®-M4 内核 32 位通用 MCU 选型



Series	Part No.	Max Speed (MHz)	Memory (Bytes)		I/O	Timer						Connectivity								EXMC	Analog Interface		Package			
			Flash	SRAM		GPTM (16bit)	Adv TM (16bit)	Bsc TM (16bit)	SysTick (24bit)	WDG	RTC	USART +UART	I <sup>2</sup> C	SPI	CAN 2.0B	USB 2.0 FS	I <sup>2</sup> S	SDIO	Ether-net		12bit ADC Units (CHs)	12bit DAC Units				
GD32E103	GD32E103T8U6	120	64K	20K	up to 26	4	1	2	1	2	1	2+0	1	1										2(10)	2	QFN36
	GD32E103TBU6	120	128K	32K	up to 26	4	1	2	1	2	1	2+0	1	1										2(10)	2	QFN36
	GD32E103C8T6	120	64K	20K	up to 37	10	1	2	1	2	1	3+0	2	3										2(10)	2	LQFP48
	GD32E103CBT6	120	128K	32K	up to 37	10	1	2	1	2	1	3+0	2	3										2(10)	2	LQFP48
	GD32E103R8T6	120	64K	20K	up to 51	10	2	2	1	2	1	3+2	2	3										2(16)	2	LQFP64
	GD32E103RBT6	120	128K	32K	up to 51	10	2	2	1	2	1	3+2	2	3										2(16)	2	LQFP64
	GD32E103V8T6	120	64K	20K	up to 80	10	2	2	1	2	1	3+2	2	3										2(16)	2	LQFP100
	GD32E103VBT6	120	128K	32K	up to 80	10	2	2	1	2	1	3+2	2	3										2(16)	2	LQFP100
GD32C103	GD32C103TBU6	120	128K	32K	up to 26	4	1	2	1	2	1	2+0	1	1	2 x FD									2(10)	2	QFN36
	GD32C103CBT6	120	128K	32K	up to 37	10	1	2	1	2	1	3+0	2	3	2 x FD									2(10)	2	LQFP48
	GD32C103RBT6	120	128K	32K	up to 51	10	2	2	1	2	1	3+2	2	3	2 x FD									2(16)	2	LQFP64
	GD32C103VBT6	120	128K	32K	up to 80	10	2	2	1	2	1	3+2	2	3	2 x FD									2(16)	2	LQFP100



Series	Part No.	Max Speed (MHz)	Memory (Bytes)		I/O	Timer						Connectivity									EXMC/SDRAM	Analog Interface		Package			
			Flash	SRAM		GPTM (16bit)	Adv TM (16bit)	GPTM (32bit)	Bsc TM (16bit)	WDG	RTC	USART+UART	I <sup>2</sup> S	SPI	CAN 2.0B	USB OTG	I <sup>2</sup> S	SDIO	LCD-TFT	Camera		ETH MAC	IPA		12bit ADC Units (CHs)	12bit DAC Units	
GD32F403	GD32F403RCT6	168	256K	64K	up to 51	8	2		2	2	1	3+2	2	3	2	OTG	2	1						0/0	3(16)	2	LQFP64
	GD32F403RET6	168	512K	96K	up to 51	8	2		2	2	1	3+2	2	3	2	OTG	2	1						0/0	3(16)	2	LQFP64
	GD32F403RGT6	168	1024K	128K	up to 51	8	2		2	2	1	3+2	2	3	2	OTG	2	1						0/0	3(16)	2	LQFP64
	GD32F403RIT6	168	2048K	128K	up to 51	8	2		2	2	1	3+2	2	3	2	OTG	2	1						0/0	3(16)	2	LQFP64
	GD32F403RKT6	168	3072K	128K	up to 51	8	2		2	2	1	3+2	2	3	2	OTG	2	1						0/0	3(16)	2	LQFP64
	GD32F403VCT6	168	256K	64K	up to 80	8	2		2	2	1	3+2	2	3	2	OTG	2	1						1/0	3(16)	2	LQFP100
	GD32F403VET6	168	512K	96K	up to 80	8	2		2	2	1	3+2	2	3	2	OTG	2	1						1/0	3(16)	2	LQFP100
	GD32F403VGT6	168	1024K	128K	up to 80	8	2		2	2	1	3+2	2	3	2	OTG	2	1						1/0	3(16)	2	LQFP100
	GD32F403VIT6	168	2048K	128K	up to 80	8	2		2	2	1	3+2	2	3	2	OTG	2	1						1/0	3(16)	2	LQFP100
	GD32F403VKT6	168	3072K	128K	up to 80	8	2		2	2	1	3+2	2	3	2	OTG	2	1						1/0	3(16)	2	LQFP100
	GD32F403VCH6	168	256K	64K	up to 80	8	2		2	2	1	3+2	2	3	2	OTG	2	1						1/0	3(16)	2	BGA100
	GD32F403VEH6	168	512K	96K	up to 80	8	2		2	2	1	3+2	2	3	2	OTG	2	1						1/0	3(16)	2	BGA100
	GD32F403VGH6	168	1024K	128K	up to 80	8	2		2	2	1	3+2	2	3	2	OTG	2	1						1/0	3(16)	2	BGA100
	GD32F403VIH6	168	2048K	128K	up to 80	8	2		2	2	1	3+2	2	3	2	OTG	2	1						1/0	3(16)	2	BGA100
	GD32F403VKH6	168	3072K	128K	up to 80	8	2		2	2	1	3+2	2	3	2	OTG	2	1						1/0	3(16)	2	BGA100
	GD32F403ZCT6	168	256K	64K	up to 112	8	2		2	2	1	3+2	2	3	2	OTG	2	1						1/0	3(21)	2	LQFP144
GD32F403ZET6	168	512K	96K	up to 112	8	2		2	2	1	3+2	2	3	2	OTG	2	1						1/0	3(21)	2	LQFP144	
GD32F403ZGT6	168	1024K	128K	up to 112	8	2		2	2	1	3+2	2	3	2	OTG	2	1						1/0	3(21)	2	LQFP144	
GD32F403ZIT6	168	2048K	128K	up to 112	8	2		2	2	1	3+2	2	3	2	OTG	2	1						1/0	3(21)	2	LQFP144	
GD32F403ZKT6	168	3072K	128K	up to 112	8	2		2	2	1	3+2	2	3	2	OTG	2	1						1/0	3(21)	2	LQFP144	
GD32F405	GD32F405RET6	168	512K	192K	up to 51	8	2	2	2	2	1	4+2	3	3	2	FS+HS	2	1			1				3(16)	2	LQFP64
	GD32F405RGT6	168	1024K	192K	up to 51	8	2	2	2	2	1	4+2	3	3	2	FS+HS	2	1			1				3(16)	2	LQFP64
	GD32F405RKT6	168	3072K	192K	up to 51	8	2	2	2	2	1	4+2	3	3	2	FS+HS	2	1			1				3(16)	2	LQFP64
	GD32F405VGT6	168	1024K	192K	up to 82	8	2	2	2	2	1	4+2	3	3	2	FS+HS	2	1			1				3(16)	2	LQFP100
	GD32F405VKT6	168	3072K	192K	up to 82	8	2	2	2	2	1	4+2	3	3	2	FS+HS	2	1			1				3(16)	2	LQFP100
	GD32F405VGH6	168	1024K	192K	up to 82	8	2	2	2	2	1	4+2	3	3	2	FS+HS	2	1			1				3(16)	2	BGA100
	GD32F405VKH6	168	3072K	192K	up to 82	8	2	2	2	2	1	4+2	3	3	2	FS+HS	2	1			1				3(16)	2	BGA100
	GD32F405ZGT6	168	1024K	192K	up to 114	8	2	2	2	2	1	4+2	3	3	2	FS+HS	2	1			1				3(24)	2	LQFP144
	GD32F405ZKT6	168	3072K	192K	up to 114	8	2	2	2	2	1	4+2	3	3	2	FS+HS	2	1			1				3(24)	2	LQFP144
	GD32F407RET6	168	512K	192K	up to 51	8	2	2	2	2	1	4+2	3	3	2	FS+HS	2	1			1	1			3(16)	2	LQFP64
GD32F407RGT6	168	1024K	192K	up to 51	8	2	2	2	2	1	4+2	3	3	2	FS+HS	2	1			1	1			3(16)	2	LQFP64	
GD32F407RKT6	168	3072K	192K	up to 51	8	2	2	2	2	1	4+2	3	3	2	FS+HS	2	1			1	1			3(16)	2	LQFP64	
GD32F407VET6	168	512K	192K	up to 82	8	2	2	2	2	1	4+2	3	3	2	FS+HS	2	1			1	1		1/0	3(16)	2	LQFP100	
GD32F407VGT6	168	1024K	192K	up to 82	8	2	2	2	2	1	4+2	3	3	2	FS+HS	2	1			1	1		1/0	3(16)	2	LQFP100	
GD32F407VKT6	168	3072K	192K	up to 82	8	2	2	2	2	1	4+2	3	3	2	FS+HS	2	1			1	1		1/0	3(16)	2	LQFP100	
GD32F407VEH6	168	512K	192K	up to 82	8	2	2	2	2	1	4+2	3	3	2	FS+HS	2	1			1	1		1/0	3(16)	2	BGA100	
GD32F407VGH6	168	1024K	192K	up to 82	8	2	2	2	2	1	4+2	3	3	2	FS+HS	2	1			1	1		1/0	3(16)	2	BGA100	
GD32F407VKH6	168	3072K	192K	up to 82	8	2	2	2	2	1	4+2	3	3	2	FS+HS	2	1			1	1		1/0	3(16)	2	BGA100	
GD32F407ZET6	168	512K	192K	up to 114	8	2	2	2	2	1	4+2	3	3	2	FS+HS	2	1			1	1		1/1	3(24)	2	LQFP144	
GD32F407ZGT6	168	1024K	192K	up to 114	8	2	2	2	2	1	4+2	3	3	2	FS+HS	2	1			1	1		1/1	3(24)	2	LQFP144	
GD32F407ZKT6	168	3072K	192K	up to 114	8	2	2	2	2	1	4+2	3	3	2	FS+HS	2	1			1	1		1/1	3(24)	2	LQFP144	
GD32F407IEH6	168	512K	192K	up to 140	8	2	2	2	2	1	4+2	3	3	2	FS+HS	2	1			1	1		1/1	3(24)	2	BGA176	
GD32F407IGH6	168	1024K	192K	up to 140	8	2	2	2	2	1	4+2	3	3	2	FS+HS	2	1			1	1		1/1	3(24)	2	BGA176	
GD32F407IKH6	168	3072K	192K	up to 140	8	2	2	2	2	1	4+2	3	3	2	FS+HS	2	1			1	1		1/1	3(24)	2	BGA176	
GD32F450	GD32F450VET6	200	512K	256K	up to 82	8	2	2	2	2	1	4+4	3	5	2	FS+HS	2	1	1	1	1	1	1	1/0	3(16)	2	LQFP100
	GD32F450VGT6	200	1024K	256K	up to 82	8	2	2	2	2	1	4+4	3	5	2	FS+HS	2	1	1	1	1	1	1	1/0	3(16)	2	LQFP100
	GD32F450VIT6	200	2048K	512K	up to 82	8	2	2	2	2	1	4+4	3	5	2	FS+HS	2	1	1	1	1	1	1	1/0	3(16)	2	LQFP100
	GD32F450VKT6	200	3072K	256K	up to 82	8	2	2	2	2	1	4+4	3	5	2	FS+HS	2	1	1	1	1	1	1	1/0	3(16)	2	LQFP100
	GD32F450ZET6	200	512K	256K	up to 114	8	2	2	2	2	1	4+4	3	6	2	FS+HS	2	1	1	1	1	1	1	1/1	3(24)	2	LQFP144
	GD32F450ZGT6	200	1024K	256K	up to 114	8	2	2	2	2	1	4+4	3	6	2	FS+HS	2	1	1	1	1	1	1	1/1	3(24)	2	LQFP144
	GD32F450ZIT6	200	2048K	512K	up to 114	8	2	2	2	2	1	4+4	3	6	2	FS+HS	2	1	1	1	1	1	1	1/1	3(24)	2	LQFP144
	GD32F450ZKT6	200	3072K	256K	up to 114	8	2	2	2	2	1	4+4	3	6	2	FS+HS	2	1	1	1	1	1	1	1/1	3(24)	2	LQFP144
	GD32F450IGH6	200	1024K	256K	up to 140	8	2	2	2	2	1	4+4	3	6	2	FS+HS	2	1	1	1	1	1	1	1/1	3(24)	2	BGA176
	GD32F450IHH6	200	2048K	512K	up to 140	8	2	2	2	2	1	4+4	3	6	2	FS+HS	2	1	1	1	1	1	1	1/1	3(24)	2	BGA176
GD32F450IKH6	200	3072K	256K	up to 140	8	2	2	2	2	1	4+4	3	6	2	FS+HS	2	1	1	1	1	1	1	1/1	3(24)	2	BGA176	



Series	Part No.	Max Speed (MHz)	Memory (Bytes)		I/O	Timer							Connectivity						Analog Interface		Package	
			Flash	SRAM		GPTM (32bit)	GPTM (16bit)	Advanced TM (16bit)	Basic TM (16bit)	SysTick (24bit)	WDG	RTC	USART	I <sup>2</sup> C	SPI	USB 2.0 FS	I <sup>2</sup> S	CEC	Comp	12bit ADC Units (CHs)		12bit DAC Units
GD32F310	GD32F310F4P6	72	16K	4K	up to 15		4	1		1	2	1	1	1	1				1(9)		TSSOP20	
	GD32F310F6P6	72	32K	6K	up to 15		4	1		1	2	1	2	1	1				1(9)		TSSOP20	
	GD32F310F8P6	72	64K	8K	up to 15		4	1		1	2	1	2	2	2				1(9)		TSSOP20	
	GD32F310G8U6	72	64K	8K	up to 23		5	1		1	2	1	2	2	2				1(10)		QFN28	
	GD32F310K8U6	72	64K	8K	up to 27		5	1		1	2	1	2	2	2				1(10)		QFN32	
	GD32F310K6T6	72	32K	6K	up to 25		4	1		1	2	1	2	1	1				1(10)		LQFP32	
	GD32F310K8T6	72	64K	8K	up to 25		5	1		1	2	1	2	2	2				1(10)		LQFP32	
	GD32F310C8T6	72	64K	8K	up to 39		5	1		1	2	1	2	2	2				1(10)		LQFP48	
GD32F330	GD32F330F4P6	84	16K	4K	up to 15	1	4	1		1	2	1	1	1	1				1(9)		TSSOP20	
	GD32F330F6P6	84	32K	4K	up to 15	1	4	1		1	2	1	2	1	1				1(9)		TSSOP20	
	GD32F330F8P6	84	64K	8K	up to 15	1	4	1		1	2	1	2	2	2				1(9)		TSSOP20	
	GD32F330G4U6	84	16K	4K	up to 23	1	4	1		1	2	1	1	1	1				1(10)		QFN28	
	GD32F330G6U6	84	32K	4K	up to 23	1	4	1		1	2	1	2	1	1				1(10)		QFN28	
	GD32F330G8U6	84	64K	8K	up to 23	1	5	1		1	2	1	2	2	2				1(10)		QFN28	
	GD32F330K4U6	84	16K	4K	up to 27	1	4	1		1	2	1	1	1	1				1(10)		QFN32	
	GD32F330K6U6	84	32K	4K	up to 27	1	4	1		1	2	1	2	1	1				1(10)		QFN32	
	GD32F330K8U6	84	64K	8K	up to 27	1	5	1		1	2	1	2	2	2				1(10)		QFN32	
	GD32F330K4T6	84	16K	4K	up to 27	1	4	1		1	2	1	1	1	1				1(10)		LQFP32	
	GD32F330K6T6	84	32K	4K	up to 27	1	4	1		1	2	1	2	1	1				1(10)		LQFP32	
	GD32F330K8T6	84	64K	8K	up to 27	1	5	1		1	2	1	2	2	2				1(10)		LQFP32	
	GD32F330C4T6	84	16K	4K	up to 39	1	4	1		1	2	1	1	1	1				1(10)		LQFP48	
	GD32F330C6T6	84	32K	4K	up to 39	1	4	1		1	2	1	2	1	1				1(10)		LQFP48	
	GD32F330C8T6	84	64K	8K	up to 39	1	5	1		1	2	1	2	2	2				1(10)		LQFP48	
	GD32F330CBT6	84	128K	16K	up to 39	1	5	1		1	2	1	2	2	2				1(10)		LQFP48	
GD32F330R8T6	84	64K	16K	up to 55	1	5	1		1	2	1	2	2	2				1(16)		LQFP64		
GD32F330RBT6	84	128K	16K	up to 55	1	5	1		1	2	1	2	2	2				1(16)		LQFP64		
GD32F350	GD32F350G4U6	108	16K	4K	up to 24	1	5	1	1	1	2	1	1	1	1	OTG	1	1	2	1(10)	1	QFN28
	GD32F350G6U6	108	32K	6K	up to 24	1	5	1	1	1	2	1	2	1	1	OTG	1	1	2	1(10)	1	QFN28
	GD32F350G8U6	108	64K	8K	up to 24	1	5	1	1	1	2	1	2	2	2	OTG	1	1	2	1(10)	1	QFN28
	GD32F350K4U6	108	16K	4K	up to 27	1	5	1	1	1	2	1	1	1	1	OTG	1	1	2	1(10)	1	QFN32
	GD32F350K6U6	108	32K	6K	up to 27	1	5	1	1	1	2	1	2	1	1	OTG	1	1	2	1(10)	1	QFN32
	GD32F350K8U6	108	64K	8K	up to 27	1	5	1	1	1	2	1	2	2	2	OTG	1	1	2	1(10)	1	QFN32
	GD32F350C4T6	108	16K	4K	up to 39	1	5	1	1	1	2	1	1	1	1	OTG	1	1	2	1(10)	1	LQFP48
	GD32F350C6T6	108	32K	6K	up to 39	1	5	1	1	1	2	1	2	1	1	OTG	1	1	2	1(10)	1	LQFP48
	GD32F350C8T6	108	64K	8K	up to 39	1	5	1	1	1	2	1	2	2	2	OTG	1	1	2	1(10)	1	LQFP48
	GD32F350CBT6	108	128K	16K	up to 39	1	5	1	1	1	2	1	2	2	2	OTG	1	1	2	1(10)	1	LQFP48
	GD32F350R4T6	108	16K	4K	up to 55	1	5	1	1	1	2	1	1	1	1	OTG	1	1	2	1(16)	1	LQFP64
	GD32F350R6T6	108	32K	8K	up to 55	1	5	1	1	1	2	1	2	1	1	OTG	1	1	2	1(16)	1	LQFP64
	GD32F350R8T6	108	64K	16K	up to 55	1	5	1	1	1	2	1	2	2	2	OTG	1	1	2	1(16)	1	LQFP64
	GD32F350RBT6	108	128K	16K	up to 55	1	5	1	1	1	2	1	2	2	2	OTG	1	1	2	1(16)	1	LQFP64



# GD32F2 系列

## ARM® Cortex®-M3 内核 32 位通用 MCU 选型



Series	Part No.	Max Speed (MHz)	Memory (Bytes)		I/O	Timer						Connectivity										EXMC/SDRAM	Analog Interface		Package				
			Flash	SRAM		GPTM (16bit)	Adv TM (16bit)	Bsc TM (16bit)	SysTick (24bit)	WDG	RTC	USART+UART	I <sup>2</sup> C	SPI	CAN 2.0B	USB 2.0 FS	I <sup>2</sup> S	SDIO	LCD-TFT	Camera	ETH MAC		Crypto/Hash	12bit ADC Units (CHs)		12bit DAC Units			
GD32F205	GD32F205RCT6	120	256K	128K	up to 51	10	2	2	1	2	1	4+2	3	3	2	OTG	2	1									3(16)	2	LQFP64
	GD32F205RET6	120	512K	128K	up to 51	10	2	2	1	2	1	4+2	3	3	2	OTG	2	1									3(16)	2	LQFP64
	GD32F205RGT6	120	1024K	256K	up to 51	10	2	2	1	2	1	4+2	3	3	2	OTG	2	1									3(16)	2	LQFP64
	GD32F205RKT6	120	3072K	256K	up to 51	10	2	2	1	2	1	4+2	3	3	2	OTG	2	1									3(16)	2	LQFP64
	GD32F205VCT6	120	256K	128K	up to 82	10	2	2	1	2	1	4+4	3	3	2	OTG	2	1	1						1/0	3(16)	2	LQFP100	
	GD32F205VET6	120	512K	128K	up to 82	10	2	2	1	2	1	4+4	3	3	2	OTG	2	1	1						1/0	3(16)	2	LQFP100	
	GD32F205VGT6	120	1024K	256K	up to 82	10	2	2	1	2	1	4+4	3	3	2	OTG	2	1	1						1/0	3(16)	2	LQFP100	
	GD32F205VKT6	120	3072K	256K	up to 82	10	2	2	1	2	1	4+4	3	3	2	OTG	2	1	1						1/0	3(16)	2	LQFP100	
	GD32F205ZCT6	120	256K	128K	up to 114	10	2	2	1	2	1	4+4	3	3	2	OTG	2	1	1						1/1	3(24)	2	LQFP144	
	GD32F205ZET6	120	512K	128K	up to 114	10	2	2	1	2	1	4+4	3	3	2	OTG	2	1	1						1/1	3(24)	2	LQFP144	
	GD32F205ZGT6	120	1024K	256K	up to 114	10	2	2	1	2	1	4+4	3	3	2	OTG	2	1	1						1/1	3(24)	2	LQFP144	
GD32F205ZKT6	120	3072K	256K	up to 114	10	2	2	1	2	1	4+4	3	3	2	OTG	2	1	1						1/1	3(24)	2	LQFP144		
GD32F207	GD32F207RCT6	120	256K	128K	up to 51	10	2	2	1	2	1	4+2	3	3	2	OTG	2	1		1	1	1				3(16)	2	LQFP64	
	GD32F207RET6	120	512K	128K	up to 51	10	2	2	1	2	1	4+2	3	3	2	OTG	2	1		1	1	1				3(16)	2	LQFP64	
	GD32F207RGT6	120	1024K	256K	up to 51	10	2	2	1	2	1	4+2	3	3	2	OTG	2	1		1	1	1				3(16)	2	LQFP64	
	GD32F207RKT6	120	3072K	256K	up to 51	10	2	2	1	2	1	4+2	3	3	2	OTG	2	1		1	1	1				3(16)	2	LQFP64	
	GD32F207VCT6	120	256K	128K	up to 82	10	2	2	1	2	1	4+4	3	3	2	OTG	2	1	1	1	1	1	1	1/0	3(16)	2	LQFP100		
	GD32F207VET6	120	512K	128K	up to 82	10	2	2	1	2	1	4+4	3	3	2	OTG	2	1	1	1	1	1	1	1/0	3(16)	2	LQFP100		
	GD32F207VGT6	120	1024K	256K	up to 82	10	2	2	1	2	1	4+4	3	3	2	OTG	2	1	1	1	1	1	1	1/0	3(16)	2	LQFP100		
	GD32F207VKT6	120	3072K	256K	up to 82	10	2	2	1	2	1	4+4	3	3	2	OTG	2	1	1	1	1	1	1	1/0	3(16)	2	LQFP100		
	GD32F207ZCT6	120	256K	128K	up to 114	10	2	2	1	2	1	4+4	3	3	2	OTG	2	1	1	1	1	1	1	1/1	3(24)	2	LQFP144		
	GD32F207ZET6	120	512K	128K	up to 114	10	2	2	1	2	1	4+4	3	3	2	OTG	2	1	1	1	1	1	1	1/1	3(24)	2	LQFP144		
	GD32F207ZGT6	120	1024K	256K	up to 114	10	2	2	1	2	1	4+4	3	3	2	OTG	2	1	1	1	1	1	1	1/1	3(24)	2	LQFP144		
	GD32F207ZKT6	120	3072K	256K	up to 114	10	2	2	1	2	1	4+4	3	3	2	OTG	2	1	1	1	1	1	1	1/1	3(24)	2	LQFP144		
	GD32F207IET6	120	512K	128K	up to 140	10	2	2	1	2	1	4+4	3	3	2	OTG	2	1	1	1	1	1	1	1/1	3(24)	2	LQFP176		
GD32F207IGT6	120	1024K	256K	up to 140	10	2	2	1	2	1	4+4	3	3	2	OTG	2	1	1	1	1	1	1	1/1	3(24)	2	LQFP176			
GD32F207IKT6	120	3072K	256K	up to 140	10	2	2	1	2	1	4+4	3	3	2	OTG	2	1	1	1	1	1	1	1/1	3(24)	2	LQFP176			



# GD32F1 系列

## ARM® Cortex®-M3 内核 32 位通用 MCU 选型



Series	Part No.	Max Speed (MHz)	Memory (Bytes)		I/O	Timer						Connectivity						EXMC	Analog Interface		Package			
			Flash	SRAM		GPTM (16bit)	Advanced TM (16bit)	Basic TM (16bit)	SysTick (24bit)	WDG	RTC	USART (UART)	I <sup>2</sup> C	SPI	CAN 2.0B	USB 2.0 FS	I <sup>2</sup> S		SDIO	Ether-net		12bit ADC Units (CHs)	12bit DAC Units	
GD32F103	GD32F103T4U6	108	16K	6K	up to 26	2	1		1	2	1	2	1	1	1	1					2(10)		QFN36	
	GD32F103T6U6	108	32K	10K	up to 26	2	1		1	2	1	2	1	1	1	1					2(10)		QFN36	
	GD32F103T8U6	108	64K	20K	up to 26	3	1		1	2	1	2	1	1	1	1					2(10)		QFN36	
	GD32F103TBU6	108	128K	20K	up to 26	3	1		1	2	1	2	1	1	1	1					2(10)		QFN36	
	GD32F103C4T6	108	16K	6K	up to 37	2	1		1	2	1	2	1	1	1	1					2(10)		LQFP48	
	GD32F103C6T6	108	32K	10K	up to 37	2	1		1	2	1	2	1	1	1	1					2(10)		LQFP48	
	GD32F103C8T6	108	64K	20K	up to 37	3	1		1	2	1	3	2	2	1	1					2(10)		LQFP48	
	GD32F103CBT6	108	128K	20K	up to 37	3	1		1	2	1	3	2	2	1	1					2(10)		LQFP48	
	GD32F103R4T6	108	16K	6K	up to 51	2	1		1	2	1	2	1	1	1	1					2(16)		LQFP64	
	GD32F103R6T6	108	32K	10K	up to 51	2	1		1	2	1	2	1	1	1	1					2(16)		LQFP64	
	GD32F103R8T6	108	64K	20K	up to 51	3	1		1	2	1	3	2	2	1	1					2(16)		LQFP64	
	GD32F103RBT6	108	128K	20K	up to 51	3	1		1	2	1	3	2	2	1	1					2(16)		LQFP64	
	GD32F103RCT6	108	256K	48K	up to 51	4	2	2	1	2	1	5	2	3	1	1	2	1			3(16)	2	LQFP64	
	GD32F103RDT6	108	384K	64K	up to 51	4	2	2	1	2	1	5	2	3	1	1	2	1			3(16)	2	LQFP64	
	GD32F103RET6	108	512K	64K	up to 51	4	2	2	1	2	1	5	2	3	1	1	2	1			3(16)	2	LQFP64	
	GD32F103RFT6	108	768K	96K	up to 51	10	2	2	1	2	1	5	2	3	1	1	2	1			3(16)	2	LQFP64	
	GD32F103RGT6	108	1024K	96K	up to 51	10	2	2	1	2	1	5	2	3	1	1	2	1			3(16)	2	LQFP64	
	GD32F103RIT6	108	2048K	96K	up to 51	10	2	2	1	2	1	5	2	3	1	1	2	1			3(16)	2	LQFP64	
	GD32F103RKT6	108	3072K	96K	up to 51	10	2	2	1	2	1	5	2	3	1	1	2	1			3(16)	2	LQFP64	
	GD32F103V8T6	108	64K	20K	up to 80	3	1		1	2	1	3	2	2	1	1					•	2(16)		LQFP100
	GD32F103VBT6	108	128K	20K	up to 80	3	1		1	2	1	3	2	2	1	1					•	2(16)		LQFP100
	GD32F103VCT6	108	256K	48K	up to 80	4	2	2	1	2	1	5	2	3	1	1	2	1			•	3(16)	2	LQFP100
	GD32F103VDT6	108	384K	64K	up to 80	4	2	2	1	2	1	5	2	3	1	1	2	1			•	3(16)	2	LQFP100
	GD32F103VET6	108	512K	64K	up to 80	4	2	2	1	2	1	5	2	3	1	1	2	1			•	3(16)	2	LQFP100
	GD32F103VFT6	108	768K	96K	up to 80	10	2	2	1	2	1	5	2	3	1	1	2	1			•	3(16)	2	LQFP100
	GD32F103VGT6	108	1024K	96K	up to 80	10	2	2	1	2	1	5	2	3	1	1	2	1			•	3(16)	2	LQFP100
	GD32F103VIT6	108	2048K	96K	up to 80	10	2	2	1	2	1	5	2	3	1	1	2	1			•	3(16)	2	LQFP100
	GD32F103VKT6	108	3072K	96K	up to 80	10	2	2	1	2	1	5	2	3	1	1	2	1			•	3(16)	2	LQFP100
	GD32F103ZCT6	108	256K	48K	up to 112	4	2	2	1	2	1	5	2	3	1	1	2	1			•	3(21)	2	LQFP144
	GD32F103ZDT6	108	384K	64K	up to 112	4	2	2	1	2	1	5	2	3	1	1	2	1			•	3(21)	2	LQFP144
	GD32F103ZET6	108	512K	64K	up to 112	4	2	2	1	2	1	5	2	3	1	1	2	1			•	3(21)	2	LQFP144
	GD32F103ZFT6	108	768K	96K	up to 112	10	2	2	1	2	1	5	2	3	1	1	2	1			•	3(21)	2	LQFP144
GD32F103ZGT6	108	1024K	96K	up to 112	10	2	2	1	2	1	5	2	3	1	1	2	1			•	3(21)	2	LQFP144	
GD32F103ZIT6	108	2048K	96K	up to 112	10	2	2	1	2	1	5	2	3	1	1	2	1			•	3(21)	2	LQFP144	
GD32F103ZKT6	108	3072K	96K	up to 112	10	2	2	1	2	1	5	2	3	1	1	2	1			•	3(21)	2	LQFP144	

# GD32F1 系列

## ARM® Cortex®-M3 内核 32 位通用 MCU 选型



Series	Part No.	Max Speed (MHz)	Memory (Bytes)		I/O	Timer						Connectivity							EXMC	Analog Interface		Package		
			Flash	SRAM		GPTM (16bit)	Advanced TM (16bit)	Basic TM (16bit)	SysTick (24bit)	WDG	RTC	USART (UART)	I <sup>2</sup> C	SPI	CAN 2.0B	USB 2.0 FS	I <sup>2</sup> S	SDIO		Ether-net	12bit ADC Units (CHs)		12bit DAC Units	
GD32F105	GD32F105R8T6	108	64K	64K	up to 51	4	1	2	1	2	1	5	2	3	2	OTG	2					2(16)	2	LQFP64
	GD32F105RBT6	108	128K	64K	up to 51	4	1	2	1	2	1	5	2	3	2	OTG	2					2(16)	2	LQFP64
	GD32F105RCT6	108	256K	96K	up to 51	4	1	2	1	2	1	5	2	3	2	OTG	2					2(16)	2	LQFP64
	GD32F105RDT6	108	384K	96K	up to 51	4	1	2	1	2	1	5	2	3	2	OTG	2					2(16)	2	LQFP64
	GD32F105RET6	108	512K	96K	up to 51	4	1	2	1	2	1	5	2	3	2	OTG	2					2(16)	2	LQFP64
	GD32F105RFT6	108	768K	96K	up to 51	4	1	2	1	2	1	5	2	3	2	OTG	2					2(16)	2	LQFP64
	GD32F105RGT6	108	1024K	96K	up to 51	4	1	2	1	2	1	5	2	3	2	OTG	2					2(16)	2	LQFP64
	GD32F105V8T6	108	64K	64K	up to 80	4	1	2	1	2	1	5	2	3	2	OTG	2			•		2(16)	2	LQFP100
	GD32F105VBT6	108	128K	64K	up to 80	4	1	2	1	2	1	5	2	3	2	OTG	2			•		2(16)	2	LQFP100
	GD32F105VCT6	108	256K	96K	up to 80	4	1	2	1	2	1	5	2	3	2	OTG	2			•		2(16)	2	LQFP100
	GD32F105VDT6	108	384K	96K	up to 80	4	1	2	1	2	1	5	2	3	2	OTG	2			•		2(16)	2	LQFP100
	GD32F105VET6	108	512K	96K	up to 80	4	1	2	1	2	1	5	2	3	2	OTG	2			•		2(16)	2	LQFP100
	GD32F105VFT6	108	768K	96K	up to 80	4	1	2	1	2	1	5	2	3	2	OTG	2			•		2(16)	2	LQFP100
	GD32F105VGT6	108	1024K	96K	up to 80	4	1	2	1	2	1	5	2	3	2	OTG	2			•		2(16)	2	LQFP100
	GD32F105ZCT6	108	256K	96K	up to 112	4	1	2	1	2	1	5	2	3	2	OTG	2			•		2(16)	2	LQFP144
GD32F105ZDT6	108	384K	96K	up to 112	4	1	2	1	2	1	5	2	3	2	OTG	2			•		2(16)	2	LQFP144	
GD32F105ZET6	108	512K	96K	up to 112	4	1	2	1	2	1	5	2	3	2	OTG	2			•		2(16)	2	LQFP144	
GD32F105ZFT6	108	768K	96K	up to 112	4	1	2	1	2	1	5	2	3	2	OTG	2			•		2(16)	2	LQFP144	
GD32F105ZGT6	108	1024K	96K	up to 112	4	1	2	1	2	1	5	2	3	2	OTG	2			•		2(16)	2	LQFP144	
GD32F107	GD32F107RBT6	108	128K	96K	up to 51	4	1	2	1	2	1	5	1	3	2	OTG	2		•			2(16)	2	LQFP64
	GD32F107RCT6	108	256K	96K	up to 51	4	1	2	1	2	1	5	1	3	2	OTG	2		•			2(16)	2	LQFP64
	GD32F107RDT6	108	384K	96K	up to 51	4	1	2	1	2	1	5	2	3	2	OTG	2		•			2(16)	2	LQFP64
	GD32F107RET6	108	512K	96K	up to 51	4	1	2	1	2	1	5	2	3	2	OTG	2		•			2(16)	2	LQFP64
	GD32F107RFT6	108	768K	96K	up to 51	4	1	2	1	2	1	5	2	3	2	OTG	2		•			2(16)	2	LQFP64
	GD32F107RGT6	108	1024K	96K	up to 51	4	1	2	1	2	1	5	2	3	2	OTG	2		•			2(16)	2	LQFP64
	GD32F107VBT6	108	128K	96K	up to 80	4	1	2	1	2	1	5	1	3	2	OTG	2		•	•		2(16)	2	LQFP100
	GD32F107VCT6	108	256K	96K	up to 80	4	1	2	1	2	1	5	1	3	2	OTG	2		•	•		2(16)	2	LQFP100
	GD32F107VDT6	108	384K	96K	up to 80	4	1	2	1	2	1	5	2	3	2	OTG	2		•	•		2(16)	2	LQFP100
	GD32F107VET6	108	512K	96K	up to 80	4	1	2	1	2	1	5	2	3	2	OTG	2		•	•		2(16)	2	LQFP100
	GD32F107VFT6	108	768K	96K	up to 80	4	1	2	1	2	1	5	2	3	2	OTG	2		•	•		2(16)	2	LQFP100
	GD32F107VGT6	108	1024K	96K	up to 80	4	1	2	1	2	1	5	2	3	2	OTG	2		•	•		2(16)	2	LQFP100
	GD32F107ZCT6	108	256K	96K	up to 112	4	1	2	1	2	1	5	2	3	2	OTG	2		•	•		2(16)	2	LQFP144
	GD32F107ZDT6	108	384K	96K	up to 112	4	1	2	1	2	1	5	2	3	2	OTG	2		•	•		2(16)	2	LQFP144
	GD32F107ZET6	108	512K	96K	up to 112	4	1	2	1	2	1	5	2	3	2	OTG	2		•	•		2(16)	2	LQFP144
GD32F107ZFT6	108	768K	96K	up to 112	4	1	2	1	2	1	5	2	3	2	OTG	2		•	•		2(16)	2	LQFP144	
GD32F107ZGT6	108	1024K	96K	up to 112	4	1	2	1	2	1	5	2	3	2	OTG	2		•	•		2(16)	2	LQFP144	

# GD32F1 系列

## ARM® Cortex®-M3 内核 32 位通用 MCU 选型



Series	Part No.	Max Speed (MHz)	Memory (Bytes)		I/O	Timer						Connectivity						Analog Interface		Package	
			Flash	SRAM		GPTM (32bit)	GPTM (16bit)	Advanced TM (16bit)	Basic TM (16bit)	SysTick (24bit)	WDG	RTC	USART	I <sup>2</sup> C	SPI	USB 2.0 FS	I <sup>2</sup> S	CEC	12bit ADC Units (CHs)		12bit DAC Units
GD32F130	GD32F130F4P6	48	16K	4K	up to 15	1	4	1		1	2	1	1	1	1				1(9)		TSSOP20
	GD32F130F6P6	48	32K	4K	up to 15	1	4	1		1	2	1	2	1	1				1(9)		TSSOP20
	GD32F130F8P6	48	64K	8K	up to 15	1	4	1		1	2	1	2	2	2				1(9)		TSSOP20
	GD32F130G4U6	48	16K	4K	up to 23	1	4	1		1	2	1	1	1	1				1(10)		QFN28
	GD32F130G6U6	48	32K	4K	up to 23	1	4	1		1	2	1	2	1	1				1(10)		QFN28
	GD32F130G8U6	48	64K	8K	up to 23	1	5	1		1	2	1	2	2	2				1(10)		QFN28
	GD32F130K4T6	48	16K	4K	up to 27	1	4	1		1	2	1	1	1	1				1(10)		QFN32
	GD32F130K6T6	48	32K	4K	up to 27	1	4	1		1	2	1	2	1	1				1(10)		QFN32
	GD32F130K8T6	48	64K	8K	up to 27	1	5	1		1	2	1	2	2	2				1(10)		QFN32
	GD32F130K4U6	48	16K	4K	up to 27	1	4	1		1	2	1	1	1	1				1(10)		QFN32
	GD32F130K6U6	48	32K	4K	up to 27	1	4	1		1	2	1	2	1	1				1(10)		QFN32
	GD32F130K8U6	48	64K	8K	up to 27	1	5	1		1	2	1	2	2	2				1(10)		QFN32
	GD32F130C4T6	48	16K	4K	up to 39	1	4	1		1	2	1	1	1	1				1(10)		LQFP48
	GD32F130C6T6	48	32K	4K	up to 39	1	4	1		1	2	1	2	1	1				1(10)		LQFP48
	GD32F130C8T6	48	64K	8K	up to 39	1	5	1		1	2	1	2	2	2				1(10)		LQFP48
GD32F130R8T6	48	64K	8K	up to 55	1	5	1		1	2	1	2	2	2				1(16)		LQFP64	
GD32F150	GD32F150G4U6	72	16K	4K	up to 24	1	5	1	1	1	2	1	1	1	1	1	1	1	1(10)	1	QFN28
	GD32F150G6U6	72	32K	6K	up to 24	1	5	1	1	1	2	1	2	1	1	1	1	1	1(10)	1	QFN28
	GD32F150G8U6	72	64K	8K	up to 24	1	5	1	1	1	2	1	2	2	2	1	1	1	1(10)	1	QFN28
	GD32F150K4U6	72	16K	4K	up to 27	1	5	1	1	1	2	1	1	1	1	1	1	1	1(10)	1	QFN32
	GD32F150K6U6	72	32K	6K	up to 27	1	5	1	1	1	2	1	2	1	1	1	1	1	1(10)	1	QFN32
	GD32F150K8U6	72	64K	8K	up to 27	1	5	1	1	1	2	1	2	2	2	1	1	1	1(10)	1	QFN32
	GD32F150C4T6	72	16K	4K	up to 39	1	5	1	1	1	2	1	1	1	1	1	1	1	1(10)	1	LQFP48
	GD32F150C6T6	72	32K	6K	up to 39	1	5	1	1	1	2	1	2	1	1	1	1	1	1(10)	1	LQFP48
	GD32F150C8T6	72	64K	8K	up to 39	1	5	1	1	1	2	1	2	2	2	1	1	1	1(10)	1	LQFP48
	GD32F150R4T6	72	16K	4K	up to 55	1	5	1	1	1	2	1	1	1	1	1	1	1	1(16)	1	LQFP64
	GD32F150R6T6	72	32K	6K	up to 55	1	5	1	1	1	2	1	2	1	1	1	1	1	1(16)	1	LQFP64
	GD32F150R8T6	72	64K	8K	up to 55	1	5	1	1	1	2	1	2	2	2	1	1	1	1(16)	1	LQFP64

# GD30 PMU

## 电源管理单元

- ◆ TWS 耳机充电盒
- ◆ 耳机和助听器
- ◆ 便携式医疗设备
- ◆ 护理监测仪
- ◆ 低电池电量应用

## 电机驱动

- ◆ 三相 BLDC 和 PMSM 电机
- ◆ 电动工具
- ◆ 机器人和遥控玩具
- ◆ 工业自动化

## 高性能电源 IC

- ◆ 无线基础设施
- ◆ 通信 / 网卡
- ◆ 工业应用
- ◆ 安防设备

## 锂电池管理

- ◆ 锂电充电和模拟前端监测
- ◆ 笔记本电脑
- ◆ 扫地机
- ◆ 航模无人机
- ◆ 能源储存

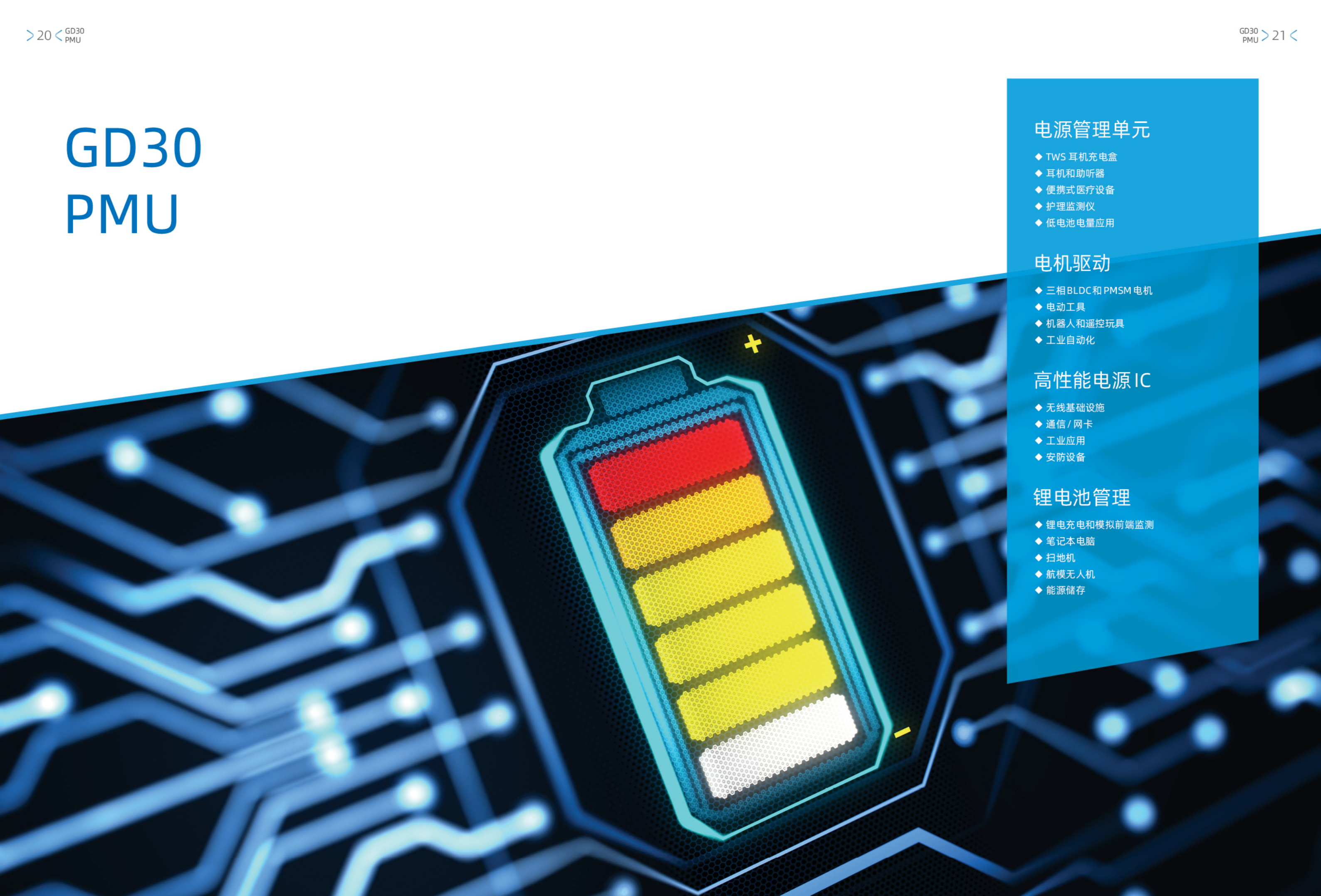

## GD30WS TWS 耳机及充电盒产品选型

Part No.	Absolute VUSB (V)	Control Topology	Charging Current (A)	Load Current (A)	Charging Efficiency (%)	CV Charge Voltage (V)	Quiescent Current (µA)	LDO	Control interface	12bit ADC	Protection Features						Temperature Operating Range (°C)	Package
	Max		Max	Max	Max						Max	Short Circuit	Over Voltage	Under Voltage	Over Current	Over Temperature		
GD30WS8805EU	20	Switch-Mode	1.2	0.6	95	4.1/4.2/4.3/4.35/4.4 @0.5%	<5	3.3V/50mA	I2C	•	•	•	•	•	•	-20 to +85	QFN24	
GD30WS8815EU	20	Switch-Mode	1.5	1	95	4.1/4.2/4.3/4.35/4.4 @0.5%	<5	3.3V/80mA	I2C	•	•	•	•	•	•	-20 to +85	QFN24	
GD30WS8855EU	20	Switch-Mode	1.2	0.6	95	4.1/4.2/4.3/4.35/4.4 @0.5%	<5	3.3V/50mA	I2C	•	•	•	•	•	•	-20 to +85	QFN24	

Part No.	Absolute VUSB (V)	Control Topology	Charging Current (A)	Load Current (A)	CV Charge Voltage (V)	Quiescent Current (µA)	LDO	Control interface	Protection Features						Temperature Operating Range (°C)	Package
	Max		8~456mA (8mA/step)	0.4~3.2A (0.2A/step)	3.6~4.545(15mV/step) @0.5%				<0.4	3.3V/50mA <th>I2C <th>Short Circuit</th> <th>Over Voltage</th> <th>Under Voltage</th> <th>Over Current</th> <th>Over Temperature</th> <th>Under Temperature</th> </th>	I2C <th>Short Circuit</th> <th>Over Voltage</th> <th>Under Voltage</th> <th>Over Current</th> <th>Over Temperature</th> <th>Under Temperature</th>	Short Circuit	Over Voltage	Under Voltage		
GD30WS8662DY	35	Linear-Mode	8~456mA (8mA/step)	0.4~3.2A (0.2A/step)	3.6~4.545(15mV/step) @0.5%	<0.4	3.3V/50mA	I2C	•	•	•	•	•	•	-40 to +85	WLCSP9

## GD30DR 电机驱动产品选型

Part No.	Supply Voltage (V)		Gate Driver	Power MOSFET	Gate Driver Peak Current (A)		Control Interface	PWM Frequency (kHz)	Buck Controller	LDO	Protection Features			Temperature Operating Range (°C)	Package
	Min	Max			Source	Sink					Max	Under Voltage	Over Temperature		
GD30DR8306KU	4.5	30	3	External	1	1.2	6xPWM, 3xPWM	200	5V/2A	5V/40mA	•	•	•	-40 to +105	QFN32

Part No.	Supply Voltage (V)		Gate Driver	Power MOSFET	Drive Current (A)	Control Interface	PWM Frequency (kHz)	LDO	Protection Features	Temperature Junction Range (°C)	Package
	Min	Max							Over Temperature		
GD30DR8413EU	4.5	30	3	Internal	3A	3xPWM	50	5V/20mA	•	-40 to +125	QFN24

## GD30LD 高精度、低噪声的 3A LDO 产品选型

Part No.	VIN (V)		VOUT (V)		Output Current (A)	Dropout Voltage @3A with BIAS (mV)	PSRR @10kHz (db)	Output Voltage Noise (µVRMS)		Ground Current (mA)	Protection Features			Temperature Junction Range (°C)	Package
	With BIAS	Without BIAS	Pin-selectable	Set by a Resistor Divider	Max			0.8V Output	5V Output		Current Limiting	Over Temperature	Power Good		
GD30LD3300FU	1.1~6.5	1.4~6.5	0.5~2.075	0.5~5.2	3	180	42	5.9	9.8	3	•	•	•	-40 to +125	QFN20
GD30LD3301FU	1.1~6.5	1.4~6.5	0.8~3.95	0.8~5.2	3	180	42	5.9	9.8	3	•	•	•	-40 to +125	QFN20

## GD30BC 多节电池充电器产品选型

Part No.	Series Cells	Input Operation Voltage (V)		Control Topology	Charging Current (A)	Charging Efficiency (%)	CV Charge Voltage for Per cell (V)	LDO	Control interface	Protection Features				Temperature Operating Range (°C)	Package
		Min	Max		Max	Max				Over Voltage	Under Voltage	Over Current	Battery Over/Under Temperature		
GD30BC2501LR	4,6	18	32	Buck	5	95	4.1/4.2/4.3/4.35@1%	3.3V/25mA	I2C	•	•	•	•	-40 to +85	QFN16

# SPI NOR Flash

## SPI NOR Flash 特性



### 3.0V

- ◆ 单电源供电
  - 电压范围：2.7V~3.6V
- ◆ 高速时钟频率
  - 数据读取频率高达 200MHz
  - 双通道数据吞吐量高达 332Mbit/s
  - 四通道数据吞吐量高达 664Mbit/s
  - 双沿传输四通道数据吞吐量高达 1600Mbit/s
  - 双沿传输八通道数据吞吐量高达 3200Mbit/s
  - 连续读取 8/16/32/64-Byte
- ◆ 灵活的存储结构
  - 扇区大小：4K Bytes
  - 块大小：32/64K Bytes

### 1.8V

- ◆ 单电源供电
  - 电压范围：1.65V~2.0V
- ◆ 高速时钟频率
  - 数据读取频率高达 200MHz
  - 双通道数据吞吐量高达 332Mbit/s
  - 四通道数据吞吐量高达 664Mbit/s
  - QPI 数据吞吐量高达 664Mbit/s
  - 双沿传输四通道数据吞吐量高达 1600Mbit/s
  - 双沿传输八通道数据吞吐量高达 3200Mbit/s
  - 连续读取 8/16/32/64-Byte
- ◆ 灵活的存储结构
  - 扇区大小：4K Bytes
  - 块大小：32/64K Bytes

### 1.65V~3.6V

- ◆ 单电源供电
  - 电压范围：1.65V~3.6V
- ◆ 高速时钟频率
  - 数据读取频率高达 104MHz
  - 双通道数据吞吐量高达 208Mbit/s
  - 四通道数据吞吐量高达 416Mbit/s
  - 连续读取 8/16/32/64-Byte
- ◆ 灵活的存储结构
  - 扇区大小：4K Bytes
  - 块大小：32/64K Bytes

\* 请翻至 25-31 页了解详情



# SPI NOR FLASH 产品型号命名规则

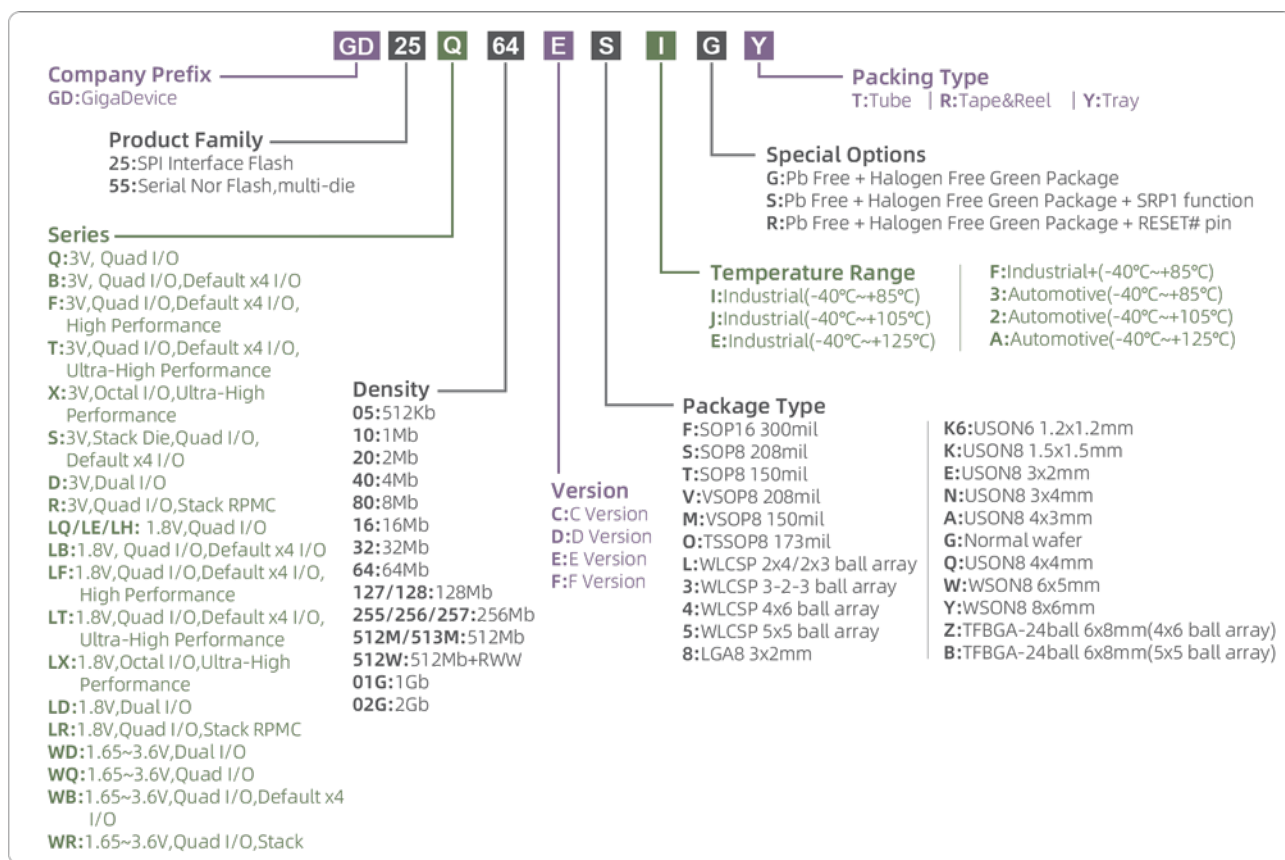

# SPI NOR Flash 产品特性

Flash Type	3.0V								1.8V								1.65V-3.6V				
	Q	B	F	X	T	R	S	D	LQ	LB	LF	LE	LX	LT	LR	LH	LD	WQ	WD	WB	WR
Part No.	xxC xxD xxE	xxC xxD xxE	xxF	xxE	xxE	xxC xxD xxE	xxD	xxD xxE	xxC xxD xxE	xxC xxD xxE	xxE	xxC xxD xxE	xxE	xxE	xxC xxD xxE	xxE	xxC xxE	xxE	xxC xxE	xxE	xxE
Single I/O (1-1-1)	.	.	.	.	.	.	.	.	.	.	.	.	.	.	.	.	.	.	.	.	.
Dual Output (1-1-2)	.	*	.	.	.	.	.	.	.	*	.	.	.	.	*	.	.	.	.	.	.
Dual I/O (1-2-2)	.	*	.	.	.	*	.	.	.	*	.	.	.	.	*	.	.	.	.	.	.
Quad Output (1-1-4)	.	.	.	.	.	.	.	.	.	.	.	.	.	.	.	.	.	.	.	.	.
Quad I/O (1-4-4)	.	.	.	.	.	.	.	.	.	.	.	.	.	.	.	.	.	.	.	.	.
Octal Output (1-1-8)	.	.	.	.	.	.	.	.	.	.	.	.	.	.	.	.	.	.	.	.	.
Octal I/O (1-8-8)	.	.	.	.	.	.	.	.	.	.	.	.	.	.	.	.	.	.	.	.	.
QPI (4-4-4)	.	.	.	.	.	.	.	.	.	.	.	.	.	.	.	.	.	.	.	.	.
OPI (8-8-8)	.	*	.	.	.	.	.	.	.	.	.	.	.	.	.	.	.	.	.	.	.
H/W Reset (RESET# Pin)	*	*	.	.	.	*	.	.	*	*	*	*	.	.	*	.	.	*	.	*	*
S/W Reset	.	.	.	.	.	.	.	.	.	.	.	.	.	.	.	.	.	.	.	.	.
H/W Write Protection (WP# Pin)	.	*	.	.	.	*	.	.	.	*	.	.	.	.	*	.	.	.	.	.	.
S/W Write Protection	.	.	.	.	.	.	.	.	.	.	.	.	.	.	.	.	.	.	.	.	.
Volatile & Non-volatile Status Register Bit	.	.	.	.	.	.	.	.	.	.	.	.	.	.	.	.	.	.	.	.	.
Output Driver Strength	*	*	.	.	.	*	.	.	*	*	*	*	.	.	*	.	.	*	.	*	*
Security Registers with OTP Locks	.	.	.	.	.	.	.	*	.	.	.	.	.	.	.	.	*	.	*	.	.
SFDP Register	.	.	.	.	.	.	.	.	.	.	.	.	.	.	.	.	.	.	.	.	.
DTR	.	*	.	.	.	.	.	.	.	*	.	.	.	.	.	.	.	.	.	.	.
ECC	.	.	*	.	.	.	.	.	.	.	.	.	.	.	.	.	.	.	.	.	.

\* 该特性仅部分产品适用

## SPI NOR Flash 产品选型

Part No.	Density	Voltage	Oragnization	I/O Bus	Frequency (MHz)	Package
GD25LD05C	512Kb	1.65V-2.0V	4KB / 32KB / 64KB	Single / Dual Output	50MHz(x1) 40MHz(x2)	SOP8 150mil USON8 1.5x1.5mm USON8 3x2mm
GD25LD10C	1Mb	1.65V-2.0V	4KB / 32KB / 64KB	Single / Dual Output	50MHz(x1) 40MHz(x2)	SOP8 150mil USON8 1.5x1.5mm USON8 3x2mm
GD25LQ20E	2Mb	1.65V-2.0V	4KB / 32KB / 64KB	Single / Dual / Quad	133MHz(x1, x2, x4)	SOP8 150mil USON8 1.5x1.5mm USON8 3x2mm
GD25LE20E	2Mb	1.65V-2.0V	4KB / 32KB / 64KB	Single / Dual / Quad	133MHz(x1, x2, x4)	SOP8 150mil USON8 1.5x1.5mm USON8 3x2mm
GD25LD20C	2Mb	1.65V-2.0V	4KB / 32KB / 64KB	Single / Dual Output	50MHz(x1) 40MHz(x2)	SOP8 150mil USON8 1.5x1.5mm USON8 3x2mm
GD25LD20E	2Mb	1.65V-2.0V	4KB / 32KB / 64KB	Single / Dual Output	50MHz(x1) 40MHz(x2)	SOP8 150mil USON8 1.5x1.5mm USON8 3x2mm
GD25LQ40E	4Mb	1.65V-2.0V	4KB / 32KB / 64KB	Single / Dual / Quad	133MHz(x1, x2, x4)	SOP8 150mil USON8 1.5x1.5mm USON8 3x2mm
GD25LE40E	4Mb	1.65V-2.0V	4KB / 32KB / 64KB	Single / Dual / Quad	133MHz(x1, x2, x4)	SOP8 150mil USON8 1.5x1.5mm USON8 3x2mm
GD25LD40C	4Mb	1.65V-2.0V	4KB / 32KB / 64KB	Single / Dual Output	50MHz(x1) 40MHz(x2)	SOP8 150mil USON8 1.5x1.5mm USON8 3x2mm
GD25LD40E	4Mb	1.65V-2.0V	4KB / 32KB / 64KB	Single / Dual Output	50MHz(x1) 40MHz(x2)	SOP8 150mil USON8 1.5x1.5mm USON8 3x2mm
GD25LH40E	4Mb	1.65V-2.0V	4KB / 32KB / 64KB	Single / Dual / Quad	133MHz(x1,x2,x4)	USON8 3x2mm USON8 1.5x1.5mm
GD25LE80E	8Mb	1.65V-2.0V	4KB / 32KB / 64KB	Single / Dual / Quad	133MHz(x1, x2, x4)	USON8 3x2mm WLCSP (4-4 ball array)
GD25LF80E	8Mb	1.65V-2.0V	4KB / 32KB / 64KB	Single / Dual / Quad	166MHz(x1, x2, x4) 104MHz(DTR)	SOP8 150mil SOP8 208mil USON8 3x2mm USON8 3x4mm
GD25LH80E	8Mb	1.65V-2.0V	4KB / 32KB / 64KB	Single / Dual / Quad	133MHz(x1, x2, x4)	VSOP8 150mil USON8 3x2mm
GD25LQ80E	8Mb	1.65V-2.0V	4KB / 32KB / 64KB	Single / Dual / Quad	133MHz(x1, x2, x4)	SOP8 150mil SOP8 208mil USON8 3x2mm
GD25LD80C	8Mb	1.65V-2.0V	4KB / 32KB / 64KB	Single / Dual Output	50MHz(x1) 40MHz(x2)	SOP8 150mil SOP8 208mil USON8 1.5x1.5mm USON8 3x2mm
GD25LD80E	8Mb	1.65V-2.0V	4KB / 32KB / 64KB	Single / Dual Output	50MHz(x1) 40MHz(x2)	SOP8 150mil SOP8 208mil USON8 1.5x1.5mm USON8 3x2mm
GD25LB16E	16Mb	1.65V-2.0V	4KB / 32KB / 64KB	Single / Dual / Quad	133MHz(x1, x2, x4)	SOP8 150mil SOP8 208mil USON8 3x2mm USON8 3x4mm WSON8 6x5mm
GD25LE16E	16Mb	1.65V-2.0V	4KB / 32KB / 64KB	Single / Dual / Quad	133MHz(x1, x2, x4)	USON8 3x2mm WLCSP (3-2-3 ball array)
GD25LF16E	16Mb	1.65V-2.0V	4KB / 32KB / 64KB	Single / Dual / Quad	166MHz(x1, x2, x4) 104MHz(DTR)	SOP8 150mil SOP8 208mil USON8 3x2mm USON8 3x4mm
GD25LH16E	16Mb	1.65V-2.0V	4KB / 32KB / 64KB	Single / Dual / Quad	133MHz(x1, x2, x4)	SOP8 150mil SOP8 208mil USON8 3x2mm USON8 3x4mm WSON8 6x5mm
GD25LQ16E	16Mb	1.65V-2.0V	4KB / 32KB / 64KB	Single / Dual / Quad	133MHz(x1, x2, x4)	SOP8 150mil SOP8 208mil USON8 3x2mm USON8 3x4mm WSON8 6x5mm WLCSP (3-2-3 ball array)
GD25LB32E	32Mb	1.65V-2.0V	4KB / 32KB / 64KB	Single / Dual / Quad	133MHz(x1, x2, x4)	SOP8 150mil SOP8 208mil USON8 3x2mm USON8 3x4mm USON8 4x4mm WSON8 6x5mm
GD25LE32E	32Mb	1.65V-2.0V	4KB / 32KB / 64KB	Single / Dual / Quad	133MHz(x1, x2, x4)	USON8 3x2mm USON8 3x4mm USON8 4x4mm WLCSP (4-4 ball array) WLCSP 3-2-3 ball array
GD25LF32E	32Mb	1.65V-2.0V	4KB / 32KB / 64KB	Single / Dual / Quad	166MHz(x1, x2, x4) 104MHz(DTR)	SOP8 150mil SOP8 208mil USON8 3x2mm USON8 3x4mm USON8 4x4mm WSON8 6x5mm
GD25LH32E	32Mb	1.65V-2.0V	4KB / 32KB / 64KB	Single / Dual / Quad	133MHz(x1, x2, x4)	SOP8 208mil USON8 3x2mm USON8 3x4mm USON8 4x4mm WSON8 6x5mm
GD25LQ32E	32Mb	1.65V-2.0V	4KB / 32KB / 64KB	Single / Dual / Quad	133MHz(x1, x2, x4)	SOP8 150mil SOP8 208mil USON8 3x2mm USON8 3x4mm USON8 4x4mm WSON8 6x5mm WLCSP (4-4 ball array)
GD25LB64E	64Mb	1.65V-2.0V	4KB / 32KB / 64KB	Single / Dual / Quad	133MHz(x1, x2, x4)	SOP8 150mil SOP8 208mil VSOP8 208mil USON8 3x4mm USON8 4x4mm WSON8 6x5mm
GD25LE64E	64Mb	1.65V-2.0V	4KB / 32KB / 64KB	Single / Dual / Quad	133MHz(x1, x2, x4)	SOP8 150mil SOP8 208mil USON8 3x4mm USON8 4x4mm WSON8 6x5mm WLCSP (4-4 ball array)
GD25LF64E	64Mb	1.65V-2.0V	4KB / 32KB / 64KB	Single / Dual / Quad	166MHz(x1, x2, x4) 104MHz(DTR)	SOP8 150mil SOP8 208mil USON8 3x4mm USON8 4x4mm WSON8 6x5mm
GD25LQ64E	64Mb	1.65V-2.0V	4KB / 32KB / 64KB	Single / Dual / Quad	133MHz(x1, x2, x4)	SOP8 150mil SOP8 208mil VSOP8 208mil USON8 3x4mm USON8 4x4mm WSON8 6x5mm WLCSP (4-4 ball array)
GD25LR64E	64Mb	1.65V-2.0V	4KB / 32KB / 64KB	Single / Dual / Quad	104MHz(x1, x2, x4)	SOP8 208mil WSON8 6x5mm
GD25LR128E	128Mb	1.65V-2.0V	4KB / 32KB / 64KB	Single / Dual / Quad	104MHz(x1, x2, x4)	SOP8 208mil WSON8 6x5mm WSON8 8x6mm
GD25LE128E	128Mb	1.65V-2.0V	4KB / 32KB / 64KB	Single / Dual / Quad	133MHz(x1, x2, x4)	SOP8 208mil USON8 4x4mm WSON8 6x5mm WSON8 8x6mm TFBGA24 8x6mm (5x5 ball array) WLCSP (4-4 ball array)
GD25LB128E	128Mb	1.65V-2.0V	4KB / 32KB / 64KB	Single / Dual / Quad	133MHz(x1, x2, x4)	SOP8 208mil SOP16 300mil USON8 4x4mm WSON8 6x5mm WSON8 8x6mm TFBGA24 8x6mm (5x5 ball array)
GD25LF128E	128Mb	1.65V-2.0V	4KB / 32KB / 64KB	Single / Dual / Quad	166MHz(x1, x2, x4) 104MHz(DTR)	SOP8 208mil USON8 4x4mm WSON8 6x5mm TFBGA24 8x6mm (5x5 ball array)
GD25LQ128E	128Mb	1.65V-2.0V	4KB / 32KB / 64KB	Single / Dual / Quad	120MHz(x1,x2,x4)	SOP8 208mil VSOP8 208mil SOP16 300mil USON8 4x4mm WSON8 6x5mm WSON8 8x6mm TFBGA24 8x6mm (5x5 ball array) WLCSP (4-4 ball array)
GD25LE255E	256Mb	1.65V-2.0V	4KB / 32KB / 64KB	Single / Dual / Quad	133MHz(x1, x2, x4)	WSON8 6x5mm WLCSP (4-4 ball array)
GD25LF255E	256Mb	1.65V-2.0V	4KB / 32KB / 64KB	Single / Dual / Quad	166MHz(x1, x2, x4) 104MHz(DTR)	WSON8 6x5mm WLCSP (4-4 ball array)
GD25LQ255E	256Mb	1.65V-2.0V	4KB / 32KB / 64KB	Single / Dual / Quad	133MHz(x1, x2, x4)	SOP16 300mil WSON8 6x5mm WSON8 8x6mm TFBGA24 8x6mm (5x5 ball array) WLCSP (4-4 ball array)
GD25LB256E	256Mb	1.65V-2.0V	4KB / 32KB / 64KB	Single / Quad	166MHz(x1, x4) 104MHz(DTR)	SOP16 300mil WSON8 8x6mm TFBGA24 8x6mm (5x5 ball array) WLCSP (4-4 ball array) WLCSP (3-2-3 ball array)
GD25LR256E	256Mb	1.65V-2.0V	4KB / 32KB / 64KB	Single / Quad	104MHz(x1, x4) 60MHz(DTR)	SOP16 300mil WSON8 6x5mm WSON8 8x6mm
GD25LT256E	256Mb	1.65V-2.0V	4KB / 32KB / 64KB	Single / Quad	166MHz(x1, x4) 200MHz(DTR)	SOP16 300mil WSON8 8x6mm TFBGA24 8x6mm (5x5 ball array)
GD25LX256E	256Mb	1.65V-2.0V	4KB / 32KB / 64KB	Single / Octal	166MHz(x1, x8) 200MHz(DTR)	SOP16 300mil TFBGA24 8x6mm (5x5 ball array) WLCSP (4x6 ball array)
GD25LB512ME	512Mb	1.65V-2.0V	4KB / 32KB / 64KB	Single / Quad	166MHz(x1, x4) 90MHz(DTR)	SOP16 300mil WSON8 8x6mm TFBGA24 8x6mm (5x5 ball array) WLCSP (3-2-3 ball array)
GD25LR512ME	512Mb	1.65V-2.0V	4KB / 32KB / 64KB	Single / Quad	104MHz(x1, x4) 60MHz(DTR)	SOP16 300mil WSON8 8x6mm
GD25LT512ME	512Mb	1.65V-2.0V	4KB / 32KB / 64KB	Single / Quad	166MHz(x1, x4) 200MHz(DTR)	SOP16 300mil WSON8 8x6mm TFBGA24 8x6mm (5x5 ball array)
GD25LX512ME	512Mb	1.65V-2.0V	4KB / 32KB / 64KB	Single / Octal	166MHz(x1, x8) 200MHz(DTR)	SOP16 300mil TFBGA24 8x6mm (5x5 ball array) WLCSP (4x6 ball array)
GD55LB01GE	1Gb	1.65V-2.0V	4KB / 32KB / 64KB	Single / Quad	166MHz(x1, x4) 90MHz(DTR)	SOP16 300mil WSON8 8x6mm TFBGA24 8x6mm (5x5 ball array)
GD55LT01GE	1Gb	1.65V-2.0V	4KB / 32KB / 64KB	Single / Quad	166MHz(x1, x4) 200MHz(DTR)	SOP16 300mil WSON8 8x6mm TFBGA24 8x6mm (5x5 ball array)
GD55LX01GE	1Gb	1.65V-2.0V	4KB / 32KB / 64KB	Single / Octal	166MHz(x1, x8) 200MHz(DTR)	SOP16 300mil TFBGA24 8x6mm (5x5 ball array)
GD55LB02GE	2Gb	1.65V-2.0V	4KB / 32KB / 64KB	Single / Quad	166MHz(x1, x4) 90MHz(DTR)	TFBGA24 8x6mm (5x5 ball array)
GD55LT02GE	2Gb	1.65V-2.0V	4KB / 32KB / 64KB	Single / Quad	166MHz(x1, x4) 200MHz(DTR)	TFBGA24 8x6mm (5x5 ball array)
GD55LX02GE	2Gb	1.65V-2.0V	4KB / 32KB / 64KB	Single / Octal	166MHz(x1, x8) 200MHz(DTR)	TFBGA24 8x6mm (5x5 ball array)
GD25D05C	512Kb	2.7V-3.6V	4KB / 32KB / 64KB	Single / Dual Output	100MHz(x1) 80MHz(x2)	SOP8 150mil TSSOP8 173mil USON8 1.5x1.5mm USON8 3x2mm
GD25D10C	1Mb	2.7V-3.6V	4KB / 32KB / 64KB	Single / Dual Output	100MHz(x1) 80MHz(x2)	SOP8 150mil TSSOP8 173mil USON8 1.5x1.5mm USON8 3x2mm
GD25Q20E	2Mb	2.7V-3.6V	4KB / 32KB / 64KB	Single / Dual / Quad	133MHz(x1, x2, x4)	SOP8 150mil SOP8 208mil USON8 3x2mm
GD25D20C	2Mb	2.7V-3.6V	4KB / 32KB / 64KB	Single / Dual Output	100MHz(x1) 80MHz(x2)	SOP8 150mil SOP8 208mil USON8 1.5x1.5mm USON8 3x2mm
GD25D20E	2Mb	2.7V-3.6V	4KB / 32KB / 64KB	Single / Dual Output	104MHz(x1) 80MHz(x2)	SOP8 150mil SOP8 208mil USON8 1.5x1.5mm USON8 3x2mm

Part No.	Density	Voltage	Organization	I/O Bus	Frequency (MHz)	Package
GD25Q40E	4Mb	2.7V-3.6V	4KB / 32KB / 64KB	Single / Dual / Quad	133MHz(x1, x2, x4)	SOP8 150mil SOP8 208mil USON8 1.5x1.5mm USON8 3x2mm
GD25D40C	4Mb	2.7V-3.6V	4KB / 32KB / 64KB	Single / Dual Output	100MHz(x1) 80MHz(x2)	SOP8 150mil SOP8 208mil USON8 1.5x1.5mm USON8 3x2mm
GD25D40E	4Mb	2.7V-3.6V	4KB / 32KB / 64KB	Single / Dual Output	104MHz(x1) 80MHz(x2)	SOP8 150mil SOP8 208mil USON8 1.5x1.5mm USON8 3x2mm
GD25Q80E	8Mb	2.7V-3.6V	4KB / 32KB / 64KB	Single / Dual / Quad	133MHz(x1, x2, x4)	SOP8 150mil SOP8 208mil USON8 3x2mm USON8 3x4mm
GD25D80C	8Mb	2.7V-3.6V	4KB / 32KB / 64KB	Single / Dual Output	100MHz(x1) 80MHz(x2)	SOP8 150mil SOP8 208mil USON8 1.5x1.5mm USON8 3x2mm
GD25D80E	8Mb	2.7V-3.6V	4KB / 32KB / 64KB	Single / Dual Output	104MHz(x1) 80MHz(x2)	SOP8 150mil SOP8 208mil USON8 1.5x1.5mm USON8 3x2mm
GD25B16E	16Mb	2.7V-3.6V	4KB / 32KB / 64KB	Single / Dual / Quad	133MHz(x1, x2, x4)	SOP8 150mil SOP8 208mil USON8 3x2mm USON8 3x4mm USON8 4x4mm WSON8 6x5mm
GD25Q16E	16Mb	2.7V-3.6V	4KB / 32KB / 64KB	Single / Dual / Quad	133MHz(x1, x2, x4)	SOP8 150mil SOP8 208mil USON8 3x2mm USON8 3x4mm USON8 4x4mm WSON8 6x5mm
GD25B32E	32Mb	2.7V-3.6V	4KB / 32KB / 64KB	Single / Dual / Quad	133MHz(x1, x2, x4)	SOP8 150mil SOP8 208mil USON8 3x2mm USON8 3x4mm WSON8 6x5mm TFBGA24 8x6mm (5x5 ball array)
GD25Q32E	32Mb	2.7V-3.6V	4KB / 32KB / 64KB	Single / Dual / Quad	133MHz(x1, x2, x4)	SOP8 150mil SOP8 208mil USON8 3x2mm USON8 3x4mm WSON8 6x5mm TFBGA24 8x6mm (5x5 ball array)
GD25R32C	32Mb	2.7V-3.6V	4KB / 32KB / 64KB	Single / Dual / Quad	104MHz(x1, x2, x4)	SOP8 208mil WSON8 6x5mm
GD25B64E	64Mb	2.7V-3.6V	4KB / 32KB / 64KB	Single / Dual / Quad	133MHz(x1, x2, x4)	SOP8 208mil SOP16 300mil USON8 3x4mm USON8 4x4mm WSON8 6x5mm TFBGA24 8x6mm (5x5 ball array)
GD25R64E	64Mb	2.7V-3.6V	4KB / 32KB / 64KB	Single / Dual / Quad	104MHz(x1, x2, x4)	SOP8 208mil WSON8 6x5mm WSON8 8x6mm
GD25F64F	64Mb	2.7V-3.6V	4KB / 32KB / 64KB	Single / Dual / Quad	166MHz(x1,x2,x4) 104MHz(DTR)	SOP8 208mil SOP16 300mil USON8 4x4mm WSON8 6x5mm WSON8 8x6mm TFBGA24 8x6mm(5x5 ball array)
GD25Q64E	64Mb	2.7V-3.6V	4KB / 32KB / 64KB	Single / Dual / Quad	133MHz(x1, x2, x4)	SOP8 150mil SOP8 208mil SOP16 300mil USON8 3x4mm USON8 4x4mm WSON8 6x5mm WSON8 8x6mm TFBGA24 8x6mm (5x5 ball array)
GD25B128E	128Mb	2.7V-3.6V	4KB / 32KB / 64KB	Single / Dual / Quad	133MHz(x1, x2, x4)	SOP8 208mil SOP16 300mil USON8 4x4mm WSON8 6x5mm WSON8 8x6mm TFBGA24 8x6mm (5x5 ball array)
GD25Q128E	128Mb	2.7V-3.6V	4KB / 32KB / 64KB	Single / Dual / Quad	133MHz(x1, x2, x4)	SOP8 208mil SOP16 300mil USON8 4x4mm WSON8 6x5mm WSON8 8x6mm TFBGA24 8x6mm (5x5 ball array) TFBGA24 8x6mm (4x6 ball array)
GD25R128E	128Mb	2.7V-3.6V	4KB / 32KB / 64KB	Single / Dual / Quad	104MHz(x1, x2, x4)	SOP8 208mil WSON8 6x5mm WSON8 8x6mm
GD25F128F	128Mb	2.7V-3.6V	4KB / 32KB / 64KB	Single / Dual / Quad	166MHz(x1, x2, x4) 104MHz(DTR)	SOP8 208mil SOP16 300mil WSON8 6x5mm TFBGA24 8x6mm (5x5 ball array)
GD25R256E	256Mb	2.7V-3.6V	4KB / 32KB / 64KB	Single / Dual / Quad	104MHz(x1, x2, x4)	SOP16 300mil WSON8 6x5mm WSON8 8x6mm
GD25B256E	256Mb	2.7V-3.6V	4KB / 32KB / 64KB	Single / Dual / Quad	133MHz(x1, x2, x4)	SOP16 300mil WSON8 6x5mm WSON8 8x6mm TFBGA24 8x6mm (5x5 ball array)
GD25F256F	256Mb	2.7V-3.6V	4KB / 32KB / 64KB	Single / Dual / Quad	166MHz(x1, x2, x4) 104MHz(DTR)	SOP16 300mil WSON8 6x5mm WSON8 8x6mm TFBGA24 8x6mm (5x5 ball array)
GD25Q256E	256Mb	2.7V-3.6V	4KB / 32KB / 64KB	Single / Dual / Quad	133MHz(x1, x2, x4)	SOP16 300mil WSON8 6x5mm WSON8 8x6mm TFBGA24 8x6mm (5x5 ball array)
GD25B512ME	512Mb	2.7V-3.6V	4KB / 32KB / 64KB	Single / Quad	133MHz(x1, x4) 90MHz(DTR)	SOP16 300mil WSON8 8x6mm TFBGA24 8x6mm (5x5 ball array)
GD25R512ME	512Mb	2.7V-3.6V	4KB / 32KB / 64KB	Single / Quad	104MHz(x1, x4) 60MHz(DTR)	SOP16 300mil WSON8 8x6mm
GD25T512ME	512Mb	2.7V-3.6V	4KB / 32KB / 64KB	Single / Quad	166MHz(x1, x4) 200MHz(DTR)	SOP16 300mil WSON8 8x6mm TFBGA24 8x6mm (5x5 ball array)
GD25X512ME	512Mb	2.7V-3.6V	4KB / 32KB / 64KB	Single / Octal	166MHz(x1, x8) 200MHz(DTR)	SOP16 300mil TFBGA24 8x6mm (5x5 ball array)
GD55B01GE	1Gb	2.7V-3.6V	4KB / 32KB / 64KB	Single / Quad	133MHz(x1, x4) 90MHz(DTR)	SOP16 300mil WSON8 8x6mm TFBGA24 8x6mm (5x5 ball array)
GD55T01GE	1Gb	2.7V-3.6V	4KB / 32KB / 64KB	Single / Quad	166MHz(x1, x4) 200MHz(DTR)	SOP16 300mil WSON8 8x6mm TFBGA24 8x6mm (5x5 ball array)
GD55X01GE	1Gb	2.7V-3.6V	4KB / 32KB / 64KB	Single / Octal	166MHz(x1, x8) 200MHz(DTR)	SOP16 300mil TFBGA24 8x6mm (5x5 ball array)
GD55B02GE	2Gb	2.7V-3.6V	4KB / 32KB / 64KB	Single / Quad	133MHz(x1, x4) 90MHz(DTR)	TFBGA24 8x6mm (5x5 ball array)
GD55T02GE	2Gb	2.7V-3.6V	4KB / 32KB / 64KB	Single / Quad	166MHz(x1, x4) 200MHz(DTR)	TFBGA24 8x6mm (5x5 ball array)
GD55X02GE	2Gb	2.7V-3.6V	4KB / 32KB / 64KB	Single / Octal	166MHz(x1, x8) 200MHz(DTR)	TFBGA24 8x6mm (5x5 ball array)
GD25WD05C	512Kb	1.65V-3.6V	4KB / 32KB / 64KB	Single / Dual Output	100MHz(x1) 80MHz(x2)	SOP8 150mil USON8 1.5x1.5mm USON8 3x2mm USON6 1.2x1.2mm
GD25WD10C	1Mb	1.65V-3.6V	4KB / 32KB / 64KB	Single / Dual Output	100MHz(x1) 80MHz(x2)	SOP8 150mil USON8 1.5x1.5mm USON8 3x2mm USON6 1.2x1.2mm
GD25WQ20E	2Mb	1.65V-3.6V	4KB / 32KB / 64KB	Single / Dual / Quad	104MHz(x1, x2, x4)	SOP8 150mil USON8 3x2mm
GD25WD20C	2Mb	1.65V-3.6V	4KB / 32KB / 64KB	Single / Dual Output	100MHz(x1) 80MHz(x2)	SOP8 150mil USON8 1.5x1.5mm USON8 3x2mm WLCSP (3-3 ball array)
GD25WD20E	2Mb	1.65V-3.6V	4KB / 32KB / 64KB	Single / Dual Output	104MHz(x1) 80MHz(x2)	SOP8 150mil USON8 1.5x1.5mm USON8 3x2mm WLCSP (3-3 ball array) USON6 1.2x1.2mm
GD25WQ40E	4Mb	1.65V-3.6V	4KB / 32KB / 64KB	Single / Dual / Quad	104MHz(x1, x2, x4)	SOP8 150mil USON8 3x2mm
GD25WD40C	4Mb	1.65V-3.6V	4KB / 32KB / 64KB	Single / Dual Output	100MHz(x1) 80MHz(x2)	SOP8 150mil TSSOP8 173mil USON8 1.5x1.5mm USON8 3x2mm WLCSP (3-3 ball array)
GD25WD40E	4Mb	1.65V-3.6V	4KB / 32KB / 64KB	Single / Dual Output	104MHz(x1) 80MHz(x2)	SOP8 150mil TSSOP8 173mil USON8 1.5x1.5mm USON8 3x2mm WLCSP (3-3 ball array) USON6 1.2x1.2mm
GD25WQ80E	8Mb	1.65V-3.6V	4KB / 32KB / 64KB	Single / Dual / Quad	104MHz(x1, x2, x4)	SOP8 150mil SOP8 208mil USON8 3x2mm
GD25WD80C	8Mb	1.65V-3.6V	4KB / 32KB / 64KB	Single / Dual Output	100MHz(x1) 80MHz(x2)	SOP8 150mil SOP8 208mil USON8 1.5x1.5mm USON8 3x2mm
GD25WD80E	8Mb	1.65V-3.6V	4KB / 32KB / 64KB	Single / Dual Output	104MHz(x1) 80MHz(x2)	SOP8 150mil SOP8 208mil USON8 1.5x1.5mm USON8 3x2mm
GD25WQ16E	16Mb	1.65V-3.6V	4KB / 32KB / 64KB	Single / Dual / Quad	104MHz(x1, x2, x4)	SOP8 150mil SOP8 208mil USON8 3x2mm USON8 3x4mm
GD25WQ32E	32Mb	1.65V-3.6V	4KB / 32KB / 64KB	Single / Dual / Quad	104MHz(x1, x2, x4)	SOP8 150mil SOP8 208mil USON8 3x2mm USON8 3x4mm
GD25WQ64E	64Mb	1.65V-3.6V	4KB / 32KB / 64KB	Single / Dual / Quad	104MHz(x1, x2, x4)	SOP8 208mil USON8 3x4mm USON8 4x4mm WSON8 6x5mm WLCSP (3-2-3 ball array)
GD25WQ128E	128Mb	1.65V-3.6V	4KB / 32KB / 64KB	Single / Dual / Quad	104MHz(x1, x2, x4)	SOP8 208mil SOP16 300mil USON8 4x4mm WSON8 6x5mm WSON8 8x6mm
GD25WB256E	256Mb	1.65V-3.6V	4KB / 32KB / 64KB	Single / Dual / Quad	104MHz(x1, x2, x4)	SOP16 300mil WSON8 6x5mm WSON8 8x6mm
GD25WR256E	256Mb	1.65V-3.6V	4KB / 32KB / 64KB	Single / Dual / Quad	104MHz(x1, x2, x4)	SOP16 300mil WSON8 6x5mm WSON8 8x6mm
GD55WB512ME	512Mb	1.65V-3.6V	4KB / 32KB / 64KB	Single / Dual / Quad	104MHz(x1, x2, x4)	SOP16 300mil WSON8 6x5mm WSON8 8x6mm TFBGA24 8x6mm(5x5 ball array)
GD55WR512ME	512Mb	1.65V-3.6V	4KB / 32KB / 64KB	Single / Dual / Quad	104MHz(x1, x2, x4)	SOP16 300mil WSON8 8x6mm

产品系列

3V

Q: Quad I/O  
 B: Quad I/O, Default x4 I/O  
 F: Quad I/O, Default x4 I/O, High Performance  
 T: Quad I/O, Default x4 I/O, Ultra-High Performance

X: Octal I/O, Ultra-High Performance  
 D: Dual I/O  
 R: Quad I/O, Stack RPMC

1.8V

LQ/LE/LH: Quad I/O  
 LB: Quad I/O, Default x4 I/O  
 LF: Quad I/O, Default x4 I/O, High Performance  
 LT: Quad I/O, Default x4 I/O, Ultra-High Performance  
 LX: Octal I/O, Ultra-High Performance  
 LD: Dual I/O  
 LR: Quad I/O, Stack RPMC

1.65V~3.6V

WD: Dual Output  
 WQ: Quad I/O  
 WB: Quad I/O, Default x4 I/O  
 WR: Quad I/O, Default x4 I/O



## SPI NOR Flash 车规产品选型

Part No.	Density	Voltage	Organization	I/O Bus	Frequency (MHz)	Packages
GD25Q20C	2Mb	2.7V-3.6V	4KB / 32KB / 64KB	Single / Dual / Quad	80MHz(x1, x2, x4)	USON8 3x2mm
GD25Q40C	4Mb	2.7V-3.6V	4KB / 32KB / 64KB	Single / Dual / Quad	80MHz(x1, x2, x4)	SOP8 150mil USON8 3x2mm
GD25Q80C	8Mb	2.7V-3.6V	4KB / 32KB / 64KB	Single / Dual / Quad	80MHz(x1, x2, x4)	SOP8 150mil SOP8 208mil USON8 3x2mm
GD25Q16C	16Mb	2.7V-3.6V	4KB / 32KB / 64KB	Single / Dual / Quad	80MHz(x1, x2, x4)	SOP8 150mil SOP8 208mil USON8 3x2mm
GD25B16C	16Mb	2.7V-3.6V	4KB / 32KB / 64KB	Single / Dual / Quad	80MHz(x1, x2, x4)	SOP8 150mil SOP8 208mil USON8 3x2mm
GD25Q32C	32Mb	2.7V-3.6V	4KB / 32KB / 64KB	Single / Dual / Quad	80MHz(x1, x2, x4)	SOP8 150mil SOP8 208mil USON8 3x4mm
GD25B32C	32Mb	2.7V-3.6V	4KB / 32KB / 64KB	Single / Dual / Quad	80MHz(x1, x2, x4)	SOP8 150mil SOP8 208mil USON8 3x4mm
GD25B32E	32Mb	2.7V-3.6V	4KB / 32KB / 64KB	Single / Dual / Quad	133MHz(x1,x2,x4)	USON8 3x2mm SOP8 150mil SOP8 208mil USON8 3x4mm
GD25Q64C	64Mb	2.7V-3.6V	4KB / 32KB / 64KB	Single / Dual / Quad	80MHz(x1, x2, x4)	SOP8 208mil WSON8 6x5mm
GD25B64C	64Mb	2.7V-3.6V	4KB / 32KB / 64KB	Single / Dual / Quad	80MHz(x1, x2, x4)	SOP8 208mil WSON8 6x5mm
GD25F64F	64Mb	2.7V-3.6V	4KB / 32KB / 64KB	Single / Dual / Quad	166MHz(x1, x2, x4) 104MHz(DTR)	SOP8 208mil USON8 4x4mm WSON8 6x5mm
GD25Q127C	128Mb	2.7V-3.6V	4KB / 32KB / 64KB	Single / Dual / Quad	80MHz(x1, x2, x4)	SOP8 208mil SOP16 300mil WSON8 6x5mm TFBGA24 8x6mm (5x5 ball array)
GD25B127D	128Mb	2.7V-3.6V	4KB / 32KB / 64KB	Single / Dual / Quad	80MHz(x1, x2, x4)	SOP8 208mil SOP16 300mil WSON8 6x5mm TFBGA24 8x6mm (5x5 ball array)
GD25F128F	128Mb	2.7V-3.6V	4KB / 32KB / 64KB	Single / Dual / Quad	166MHz(x1, x2, x4) 104MHz(DTR)	SOP8 208mil SOP16 300mil WSON8 6x5mm TFBGA24 8x6mm (5x5 ball array)
GD25Q257D	256Mb	2.7V-3.6V	4KB / 32KB / 64KB	Single / Dual / Quad	104MHz(x1, x2, x4) 104MHz(DTR)	SOP16 300mil WSON8 8x6mm TFBGA24 8x6mm (5x5 ball array)
GD25F256F	256Mb	2.7V-3.6V	4KB / 32KB / 64KB	Single / Dual / Quad	166MHz(x1, x2, x4) 104MHz(DTR)	SOP16 300mil WSON8 6x5mm WSON8 8x6mm TFBGA24 8x6mm (5x5 ball array)
GD25T512ME	512Mb	2.7V-3.6V	4KB / 32KB / 64KB	Single / Quad	166MHz(x1, x4) 200MHz(DTR)	SOP16 300mil WSON8 8x6mm TFBGA24 8 x6mm (5x5 ball array)
GD25X512ME	512Mb	2.7V-3.6V	4KB / 32KB / 64KB	Single / Octal	166MHz(x1, x8) 200MHz(DTR)	SOP16 300mil TFBGA24 8x6mm (5x5 ball array)
GD55T01GE	1Gb	2.7V-3.6V	4KB / 32KB / 64KB	Single / Quad	166MHz(x1, x4) 200MHz(DTR)	SOP16 300mil WSON8 8x6mm TFBGA24 8x6mm (5x5 ball array)
GD55X01GE	1Gb	2.7V-3.6V	4KB / 32KB / 64KB	Single / Octal	166MHz(x1, x8) 200MHz(DTR)	SOP16 300mil TFBGA24 8x6mm (5x5 ball array)
GD55T02GE	2Gb	2.7V-3.6V	4KB / 32KB / 64KB	Single / Quad	166MHz(x1, x4) 200MHz(DTR)	TFBGA24 8x6mm (5x5 ball array)
GD55X02GE	2Gb	2.7V-3.6V	4KB / 32KB / 64KB	Single / Octal	166MHz(x1, x8) 200MHz(DTR)	TFBGA24 8x6mm (5x5 ball array)
GD25LQ20C	2Mb	1.65V-2.0V	4KB / 32KB / 64KB	Single / Dual / Quad	104MHz(x1, x2, x4)	USON8 3x2mm
GD25LQ40C	4Mb	1.65V-2.0V	4KB / 32KB / 64KB	Single / Dual / Quad	104MHz(x1, x2, x4)	USON8 3x2mm
GD25LQ80C	8Mb	1.65V-2.0V	4KB / 32KB / 64KB	Single / Dual / Quad	104MHz(x1, x2, x4)	LGA8 3x2mm
GD25LQ80E	8Mb	1.65V-2.0V	4KB / 32KB / 64KB	Single / Dual / Quad	133MHz(x1, x2, x4)	USON8 3x2mm
GD25LQ16C	16Mb	1.65V-2.0V	4KB / 32KB / 64KB	Single / Dual / Quad	104MHz(x1, x2, x4)	SOP8 150mil USON8 3x4mm
GD25LQ16E	16Mb	1.65V-2.0V	4KB / 32KB / 64KB	Single / Dual / Quad	133MHz(x1, x2, x4)	USON8 3x2mm SOP8 150mil USON8 3x4mm
GD25LQ32E	32Mb	1.65V-2.0V	4KB / 32KB / 64KB	Single / Dual / Quad	133MHz(x1, x2, x4)	SOP8 208mil USON8 3x2mm USON8 3x4mm
GD25LQ64E	64Mb	1.65V-2.0V	4KB / 32KB / 64KB	Single / Dual / Quad	133MHz(x1, x2, x4)	SOP8 208mil USON8 3x4mm USON8 4x4mm WSON8 6x5mm
GD25LQ128D	128Mb	1.65V-2.0V	4KB / 32KB / 64KB	Single / Dual / Quad	120MHz(x1, x2, x4)	SOP8 208mil WSON8 6x5mm TFBGA24 8x6mm (5x5 ball array)
GD25LQ128E	133Mb	1.65V-2.0V	4KB / 32KB / 64KB	Single / Dual / Quad	120MHz(x1, x2, x4)	USON8 4x4mm
GD25LT256E	256Mb	1.65V-2.0V	4KB / 32KB / 64KB	Single / Quad	166MHz(x1, x4) 200MHz(DTR)	SOP16 300mil WSON8 8x6mm TFBGA24 8x6mm (5x5 ball array) WSON8 6x5mm
GD25LX256E	256Mb	1.65V-2.0V	4KB / 32KB / 64KB	Single / Octal	166MHz(x1, x8) 200MHz(DTR)	SOP16 300mil TFBGA24 8x6mm (5x5 ball array)
GD25LT512ME	512Mb	1.65V-2.0V	4KB / 32KB / 64KB	Single / Quad	166MHz(x1, x4) 200MHz(DTR)	SOP16 300mil WSON8 8x6mm TFBGA24 8x6mm (5x5 ball array)
GD25LX512ME	512Mb	1.65V-2.0V	4KB / 32KB / 64KB	Single / Octal	166MHz(x1, x8) 200MHz(DTR)	SOP16 300mil TFBGA24 8x6mm (5x5 ball array)
GD55LT01GE	1Gb	1.65V-2.0V	4KB / 32KB / 64KB	Single / Quad	166MHz(x1, x4) 200MHz(DTR)	SOP16 300mil WSON8 8x6mm TFBGA24 8x6mm (5x5 ball array)
GD55LX01GE	1Gb	1.65V-2.0V	4KB / 32KB / 64KB	Single / Octal	166MHz(x1, x8) 200MHz(DTR)	SOP16 300mil TFBGA24 8x6mm (5x5 ball array)
GD55LT02GE	2Gb	1.65V-2.0V	4KB / 32KB / 64KB	Single / Quad	166MHz(x1, x4) 200MHz(DTR)	TFBGA24 8x6mm (5x5 ball array)
GD55LX02GE	2Gb	1.65V-2.0V	4KB / 32KB / 64KB	Single / Octal	166MHz(x1, x8) 200MHz(DTR)	TFBGA24 8x6mm (5x5 ball array)

产品系列

3V

Q: Quad I/O  
B: Quad I/O, Default x4 I/O  
F: Quad I/O, Default x4 I/O, High Performance

T: Quad I/O, Default x4 I/O, Ultra-High Performance  
X: Octal I/O, Ultra-High Performance

1.8V

LQ: Quad I/O  
LT: Quad I/O, Default x4 I/O, Ultra-High Performance

LX: Octal I/O, Ultra-High Performance



# SPI NAND Flash

## SPI NAND Flash 特性



### 3.3V

- ◆ 供电电压: 2.7V~3.6V
- ◆ 高速时钟频率
  - 数据读取频率高达 133MHz
  - 四通道数据吞吐量高达 532Mbit/s
- ◆ 灵活的存储结构
  - 2K Byte 页读取写入大小
  - 128K Byte 块擦除大小
- ◆ 增强访问性能
  - 提供 2K Byte Cache 空间随机读取
- ◆ SPI NAND 先进特性
  - 内置 ECC 算法
  - 内部数据搬移
  - 通过 ECC 确保 Block0 为出厂好块

### 1.8V

- ◆ 供电电压: 1.7V~2.0V
- ◆ 高速时钟频率
  - 数据读取频率高达 104MHz
  - 四通道数据吞吐量高达 416Mbit/s
- ◆ 灵活的存储结构
  - 2K Byte 页读取写入大小
  - 128K Byte 块擦除大小
- ◆ 增强访问性能
  - 提供 2K Byte Cache 空间随机读取
- ◆ SPI NAND 先进特性
  - 内置 ECC 算法
  - 内部数据搬移
  - 通过 ECC 确保 Block0 为出厂好块

## SPI NAND Flash 产品选型

Part No.	Density	Voltage	Frequency	I/O Bus	Page Size	Package
GD5F1GQ5UE	1Gb	3.3V	133MHZ	x1/x2/x4	2KB	WSO8 8*6mm/WSO8 6*5mm/ TFBGA24(5x5 ball array)
GD5F1GM7UE	1Gb	3.3V	133MHZ	x1/x2/x4	2KB	WSO8 8*6mm/WSO8 6*5mm
GD5F2GQ5UE	2Gb	3.3V	104MHZ	x1/x2/x4	2KB	WSO8 8*6mm/TFBGA24(5x5 ball array)/ TFBGA24(4x6 ball array)
GD5F2GM7UE	2Gb	3.3V	133MHZ	x1/x2/x4	2KB	WSO8 8*6mm/WSO8 6*5mm
GD5F4GQ6UE	4Gb	3.3V	104MHZ	x1/x2/x4	2KB	WSO8 8*6mm
GD5F4GM8UE	4Gb	3.3V	133MHZ	x1/x2/x4	2KB	WSO8 8*6mm
GD5F1GQ5RE	1Gb	1.8V	104MHZ	x1/x2/x4	2KB	WSO8 8*6mm/WSO8 6*5mm/ TFBGA24(5x5 ball array)
GD5F1GM7RE	1Gb	1.8V	104MHZ	x1/x2/x4	2KB	WSO8 8*6mm/WSO8 6*5mm
GD5F2GQ5RE	2Gb	1.8V	80MHZ	x1/x2/x4	2KB	WSO8 8*6mm/TFBGA24(5x5 ball array)/ TFBGA24(4x6 ball array)
GD5F2GM7RE	2Gb	1.8V	104MHZ	x1/x2/x4	2KB	WSO8 8*6mm/WSO8 6*5mm
GD5F4GQ6RE	4Gb	1.8V	80MHZ	x1/x2/x4	2KB	WSO8 8*6mm
GD5F4GM8RE	4Gb	1.8V	104MHZ	x1/x2/x4	2KB	WSO8 8*6mm

## SPI NAND Flash 车规产品选型

Part No.	Density	Voltage	Frequency	I/O Bus	Page Size	Package
GD5F1GQ5UE	1Gb	3.3V	133MHZ	x1/x2/x4	2KB	WSO8 8*6mm
GD5F2GQ5UE	2Gb	3.3V	104MHZ	x1/x2/x4	2KB	WSO8 8*6mm
GD5F4GQ6UE	4Gb	3.3V	104MHZ	x1/x2/x4	2KB	WSO8 8*6mm
GD5F1GQ5RE	1Gb	1.8V	104MHZ	x1/x2/x4	2KB	WSO8 8*6mm
GD5F2GQ5RE	2Gb	1.8V	80MHZ	x1/x2/x4	2KB	WSO8 8*6mm
GD5F4GQ6RE	4Gb	1.8V	80MHZ	x1/x2/x4	2KB	WSO8 8*6mm

## SPI NAND Flash 产品型号命名规则

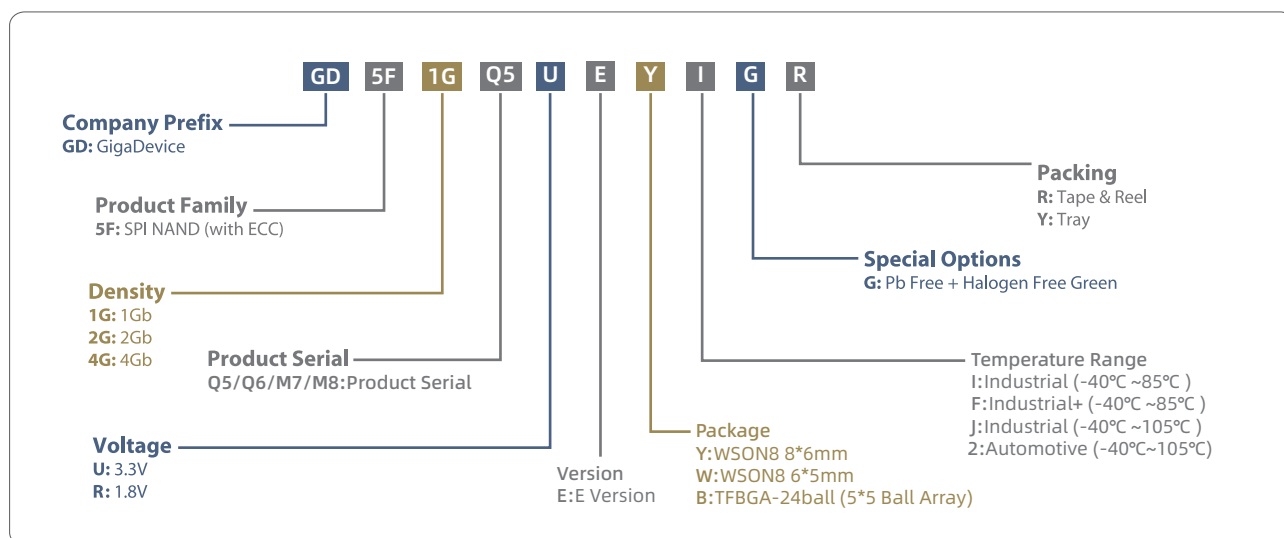

# 并口 NAND Flash

## Parallel NAND Flash 特性

### 3.3V

- ◆ 供电电压: 2.7V~3.6V
- ◆ 容量: 1Gb/2Gb/4Gb/8Gb
- ◆ 页大小: 2K+64 Byte / 2K+128 Byte / 4K+256 Byte
- ◆ 页读取时间: 25us
- ◆ I/O 传输速度: 12ns/20ns/25ns
- ◆ 总线宽度: x8/x16
- ◆ 温度等级: 工业级 -40~85°C / 工业级 -40~105°C
- ◆ 符合 ONFI1.0 标准

### 1.8V

- ◆ 供电电压: 1.7V~1.95V
- ◆ 容量: 1Gb/2Gb/4Gb/8Gb
- ◆ 页大小: 2K+64 Byte / 2K+128 Byte
- ◆ 页读取时间: 25us
- ◆ I/O 传输速度: 20ns/25ns/45ns
- ◆ 总线宽度: x8/x16
- ◆ 温度等级: 工业级 -40~85°C / 工业级 -40~105°C
- ◆ 符合 ONFI1.0 标准

## Parallel NAND Flash 产品选型

Part No.	Density	Voltage	Sequential Access Time	I/O Bus	Page Size	ECC Requirement	Package
GD9FU1GxF2A	1Gb	3.3V	25ns	x8/x16	2KB+128B	4bit/512B	TSOP48 20*12mm/BGA63 9*11mm
GD9FU1GxF3A	1Gb	3.3V	25ns	x8/x16	2KB+64B	4bit/512B	TSOP48 20*12mm/BGA63 9*11mm
GD9FU1G8F2D	1Gb	3.3V	12ns	x8	2KB+128B	8bit/512B	TSOP48 20*12mm/BGA63 9*11mm
GD9FU2GxF2A	2Gb	3.3V	20ns	x8/x16	2KB+128B	4bit/512B	TSOP48 20*12mm/BGA63 9*11mm
GD9FU2GxF3A	2Gb	3.3V	20ns	x8/x16	2KB+64B	4bit/512B	TSOP48 20*12mm/BGA63 9*11mm
GD9FU4GxF2A	4Gb	3.3V	20ns	x8/x16	2KB+128B	4bit/512B	TSOP48 20*12mm/BGA63 9*11mm
GD9FU4GxF3A	4Gb	3.3V	20ns	x8/x16	2KB+64B	4bit/512B	TSOP48 20*12mm/BGA63 9*11mm
GD9FU4GxF4B	4Gb	3.3V	25ns	x8/x16	4KB+256B	8bit/512B	TSOP48 20*12mm/BGA63 9*11mm
GD9FU8GxE2A	8Gb	3.3V	20ns	x8/x16	2KB+128B	4bit/512B	TSOP48 20*12mm/BGA63 9*11mm
GD9FU8GxE3A	8Gb	3.3V	20ns	x8/x16	2KB+64B	4bit/512B	TSOP48 20*12mm/BGA63 9*11mm
GD9FU8GxE4B	8Gb	3.3V	25ns	x8/x16	4KB+256B	8bit/512B	TSOP48 20*12mm/BGA63 9*11mm
GD9AU2GxF3A	2Gb	3.3V	20ns	x8/x16	2KB+64B	Internal 4bit/512B	TSOP48 20*12mm/BGA63 9*11mm
GD9AU4GxF3A	4Gb	3.3V	20ns	x8/x16	2KB+64B	Internal 4bit/512B	TSOP48 20*12mm/BGA63 9*11mm
GD9AU8GxE3A	8Gb	3.3V	20ns	x8/x16	2KB+64B	Internal 4bit/512B	TSOP48 20*12mm/BGA63 9*11mm
GD9FS1GxF2A	1Gb	1.8V	45ns	x8/x16	2KB+128B	4bit/512B	TSOP48 20*12mm/BGA63 9*11mm
GD9FS1GxF3A	1Gb	1.8V	45ns	x8/x16	2KB+64B	4bit/512B	TSOP48 20*12mm/BGA63 9*11mm
GD9FS1G8F2D	1Gb	1.8V	20ns	x8	2KB+128B	8bit/512B	TSOP48 20*12mm/BGA63 9*11mm
GD9FS2GxF2A	2Gb	1.8V	25ns	x8/x16	2KB+128B	4bit/512B	TSOP48 20*12mm/BGA63 9*11mm
GD9FS2GxF3A	2Gb	1.8V	25ns	x8/x16	2KB+64B	4bit/512B	TSOP48 20*12mm/BGA63 9*11mm
GD9FS4GxF2A	4Gb	1.8V	25ns	x8/x16	2KB+128B	4bit/512B	TSOP48 20*12mm/BGA63 9*11mm
GD9FS4GxF3A	4Gb	1.8V	25ns	x8/x16	2KB+64B	4bit/512B	TSOP48 20*12mm/BGA63 9*11mm
GD9FS8GxE2A	8Gb	1.8V	25ns	x8/x16	2KB+128B	4bit/512B	TSOP48 20*12mm/BGA63 9*11mm
GD9FS8GxE3A	8Gb	1.8V	25ns	x8/x16	2KB+64B	4bit/512B	TSOP48 20*12mm/BGA63 9*11mm
GD9AS2GxF3A	2Gb	1.8V	25ns	x8/x16	2KB+64B	Internal 4bit/512B	TSOP48 20*12mm/BGA63 9*11mm
GD9AS4GxF3A	4Gb	1.8V	25ns	x8/x16	2KB+64B	Internal 4bit/512B	TSOP48 20*12mm/BGA63 9*11mm
GD9AS8GxE3A	8Gb	1.8V	25ns	x8/x16	2KB+64B	Internal 4bit/512B	TSOP48 20*12mm/BGA63 9*11mm

备注：该型号支持内置 ECC，无需额外 ECC。

## Parallel NAND Flash 产品型号命名规则

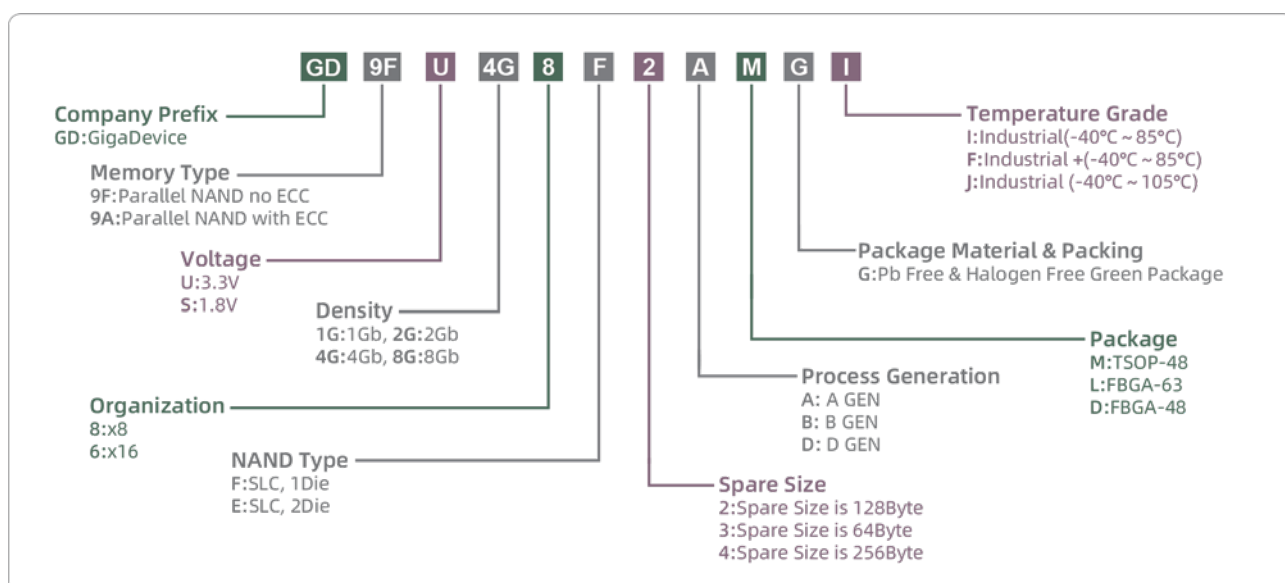



# Flash 产品 封装形式

T		SOP8 150mil	
		长度	4.90mm
		宽度	6.00mm
		厚度 (最大)	1.75mm
		间距	1.27mm

F		SOP16 300mil	
		长度	10.30mm
		宽度	10.35mm
		厚度 (最大)	2.75mm
		间距	1.27mm

S		SOP8 208mil	
		长度	5.23mm
		宽度	7.90mm
		厚度 (最大)	2.16mm
		间距	1.27mm

Z		TFBGA-24ball 6*8mm (4*6ball array)	
		长度	6.00mm
		宽度	8.00mm
		厚度 (最大)	1.20mm
		间距	1.00mm

M		VSOP8 150mil	
		长度	4.90mm
		宽度	6.00mm
		厚度 (最大)	0.90mm
		间距	1.27mm

B		TFBGA-24ball 6*8mm (5*5ball array)	
		长度	6.00mm
		宽度	8.00mm
		厚度 (最大)	1.20mm
		间距	1.00mm

M		TSOP48	
		长度	12.0mm
		宽度	20.0mm
		厚度 (最大)	1.20mm
		间距	0.50mm

8		LGA8 3*2mm	
		长度	3.00mm
		宽度	2.00mm
		厚度 (最大)	0.50mm
		间距	0.50mm

V		VSOP8 208mil	
		长度	5.28mm
		宽度	7.90mm
		厚度 (最大)	1.00mm
		间距	1.27mm

9		LGA8 8*6mm	
		长度	8.00mm
		宽度	6.00mm
		厚度 (最大)	0.80mm
		间距	1.27mm

备注:

1. 提供的长度、宽度、间距数值为标准值。厚度数值为最大值。
2. 图片仅供参考，请以所选型号的数据手册为主。

K		USON8 1.5*1.5mm	
		长度	1.50mm
		宽度	1.50mm
		厚度 (最大)	0.50mm
		间距	0.40mm

W		WSO8 6*5mm	
		长度	6.00mm
		宽度	5.00mm
		厚度 (最大)	0.80mm
		间距	1.27mm

E		USON8 3*2mm (0.45mm)	
		长度	3.00mm
		宽度	2.00mm
		厚度 (最大)	0.50mm
		间距	0.50mm

Y		WSO8 8*6mm	
		长度	8.00mm
		宽度	6.00mm
		厚度 (最大)	0.80mm
		间距	1.27mm

N		USON8 3*4mm	
		长度	3.00mm
		宽度	4.00mm
		厚度 (最大)	0.60mm
		间距	0.80mm

L		WLCSP	
		取决于具体产品	

Q		USON8 4*4mm	
		长度	4.00mm
		宽度	4.00mm
		厚度 (最大)	0.50mm
		间距	0.80mm

L		FBGA63	
		长度	9.00mm
		宽度	11.00mm
		厚度 (最大)	1.00mm
		间距	0.80mm

# 电容触控 芯片

## 电容触控芯片特性

- ◆ 极强的抗 RF, LCD 和电源干扰能力
- ◆ 同时探测多达 10 个触摸点
- ◆ 面板厚度：可支持最厚达 2.5mm 玻璃盖板，  
可支持最厚达 1.2mm 塑料盖板
- ◆ I2C 兼容从属模式, 400KHz
- ◆ I/O 接口兼容 1.8/3.3 V



## 手机触控芯片产品选型

Item	GSL1691F	GSL2681C	GSL915	GSL2338
Number of channels	18TX, 12RX	23TX, 12RX	26TX, 14RX	40 RX
Multi-touch points	5 points	5 points	5 points	2 points
Panel dimension	up to 7"	up to 7"	up to 7"	up to 5.5"
Wake-up gestures	Yes	Yes	Yes	Yes
TP compatible mode	Tx line Floating	Tx line Floating	GPIO(9 mode) + Tx line Floating	Rx line Floating
Panel dimension and pixel	5.0Inch(960*540) 5.0Inch(1280*720) 5.3Inch(800*480) 5.3Inch(960*540) 5.7Inch(1280*720) 6.0Inch(960*540) 6.0Inch(1280*720) 7Inch(800*480) 7Inch(1024*600)	5.0Inch(960*540) 5.0Inch(1280*720) 5.3Inch(800*480) 5.3Inch(960*540) 5.7Inch(1280*720) 6.0Inch(960*540) 6.0Inch(1280*720) 7Inch(800*480) 7Inch(1024*600)	5.0Inch(960*540) 5.0Inch(1280*720) 5.3Inch(800*480) 5.3Inch(960*540) 5.7Inch(1280*720) 6.0Inch(960*540) 6.0Inch(1280*720) 7Inch(800*480) 7Inch(1024*600)	5.0Inch(960*540) 5.0Inch(1280*720) 5.3Inch(800*480) 5.3Inch(960*540) 5.5Inch(1280*720)
Value proposition	Support single layer and multi-touch, high cost effectiveness	Support single layer and multi-touch, high performance	Support single layer and multi-touch, high performance	Self-capacitance, high cost effectiveness
Sensor profile	5*5*0.8mm	6*6*0.8mm	6*6*0.8mm	5*5*0.55mm
Package	QFN40	QFN48	QFN52	QFN48
High channel loading resistance support	Yes	Yes	Yes	Yes
Sensor pattern	OGS, SITO, DITO	OGS, SITO, DITO	OGS, SITO, DITO	SITO (duel segmentation)
Process support	1. Photolithography process 2. Laser process 3. Printing process	1. Photolithography process 2. Laser process 3. Printing process	1. Photolithography process 2. Laser process 3. Printing process	Printing process
Voltage	2.8V/3.0V/3.3V	2.8V/3.0V/3.3V	2.8V/3.0V/3.3V	2.8V/3.0V/3.3V
Communication	I2C	I2C	I2C	I2C

## 平板触控芯片产品选型

Item	GSL1680F	GSL1686F	GSL2681C		GSL3670D	GSL3676	GSL3680	GSL3692	GSL5680
Number of channels	16TX, 10RX	16TX, 10RX	23TX, 12RX		26TX, 14RX	28TX, 18RX	31TX, 20RX	32TX, 24RX	40TX, 32RX
Multi-touch Points	5~10 point	5~10 point	5~10 point		5~10 point	5~10 point	5~10 point	5~10 point	5~10 point
Panel dimension	up to 7"	up to 7"	up to 8"		up to 10.1"	up to 10.1"	up to 13.5"	up to 13.5"	up to 15.6"
Wake-up gestures	Yes	Yes	Yes		Yes	Yes	Yes	Yes	Yes
TP compatible mode	GPIO(2 modes)+ Tx line floating	GPIO(2 modes)+ Tx line floating	Tx line floating		GPIO(9 modes)+ Tx line floating	Tx line floating	GPIO(8 modes)+ Tx line floating	GPIO(6 modes)+ Tx line floating	GPIO(9 modes)+ Tx line floating
Panel dimension and pixel	7Inch(800*480) 7Inch(1024*600) 8Inch(800*600)	7Inch(800*480) 7Inch(1024*600) 8Inch(800*600)	7Inch(1024*600) 7Inch(1280*800) 7.85Inch(1024*768) 8Inch(800*600) 8Inch(1024*768)		7Inch(1280*800) 7.85Inch(1024*768) 7.85Inch(1280*800) 8Inch(1024*768) 8Inch(1280*800) 9Inch(800*480) 9Inch(1024*600) 9Inch(1024*768) 9Inch(1280*800) 9.7Inch(800*480) 10.1Inch(1024*768) 10.1Inch(1366*768)	7Inch(1280*800) 7.85Inch(1024*768) 7.85Inch(1280*800) 8Inch(1024*768) 8Inch(1280*800) 9Inch(800*480) 9Inch(1024*600) 9Inch(1024*768) 9Inch(1280*800) 9.7Inch(800*480) 10.1Inch(1024*768) 10.1Inch(1366*768)	7Inch(1280*800) 7.85Inch(1024*768) 7.85Inch(1280*800) 8Inch(1024*768) 8Inch(1280*800) 9Inch(800*480) 9Inch(1024*600) 9Inch(1024*768) 9Inch(1280*800) 9.7Inch(800*480) 10.1Inch(1024*768) 10.1Inch(1366*768) customer requirement	7Inch(1280*800) 7.85Inch(1024*768) 7.85Inch(1280*800) 8Inch(1024*768) 8Inch(1280*800) 9Inch(800*480) 9Inch(1024*600) 9Inch(1024*768) 9Inch(1280*800) 9.7Inch(800*480) 10.1Inch(1024*768) 10.1Inch(1366*768) customer requirement	7Inch(1280*800) 7.85Inch(1024*768) 7.85Inch(1280*800) 8Inch(1024*768) 8Inch(1280*800) 9Inch(800*480) 9Inch(1024*600) 9Inch(1024*768) 9Inch(1280*800) 9.7Inch(800*480) 10.1Inch(1024*768) 10.1Inch(1366*768) customer requirement
Sensor profile	5*5*0.8mm	5*5*0.8mm	6*6*0.8mm		6*6*0.8mm	7*7*0.8mm	8*8*0.8mm	8*8*0.8mm	10*10*0.8mm
Package	QFN40	QFN40	QFN48		QFN52	QFN56	QFN68	QFN68	QFN88
Value proposition	Support single layer and multi-touch, high cost effectiveness	Support single layer and multi-touch, high cost effectiveness, compatible with GSL1680	Support single layer and multi-touch, high cost effectiveness		Support single layer and multi-touch, high cost effectiveness	Support single layer and multi-touch, big panel size	Support single layer and multi-touch, big panel size	Support single layer and multi-touch, big panel size	Support single layer and multi-touch, big panel size
High channel loading resistance support	Yes	Yes	Yes		Yes	Yes	Yes	Yes	Yes
Sensor pattern	DITO	OGS, SITO, DITO	OGS, SITO, DITO		OGS, SITO, DITO	OGS, SITO, DITO	OGS, SITO, DITO	OGS, SITO, DITO	DITO
Process support	1. Photolithography process 2. Laser process 3. Printing process	1. Photolithography process 2. Laser process 3. Printing process	1. Photolithography process 2. Laser process 3. Printing process		1. Photolithography process 2. Laser process 3. Printing process	1. Photolithography process 2. Laser process 3. Printing process	1. Photolithography process 2. Laser process 3. Printing process	1. Photolithography process 2. Laser process 3. Printing process	1. Photolithography process 2. Laser process 3. Printing process
Voltage	2.8V/3.0V/3.3V	2.8V/3.0V/3.3V	2.8V/3.0V/3.3V		2.8V/3.0V/3.3V	2.8V/3.0V/3.3V	2.8V/3.0V/3.3V	2.8V/3.0V/3.3V	2.8V/3.0V/3.3V
Communication	I2C	I2C	I2C		I2C	I2C	I2C	I2C	I2C



# 指纹 传感器

## 电容指纹 传感器特性

- ◆ 支持圆形 / 方形 / 长条形等各种形状
- ◆ 支持不同直径的圆,不同长度的方形和长条形,尤其有超窄尺寸
- ◆ 支持放置在智能手机正面 / 背面 / 侧边等不同位置
- ◆ 支持不同表面处理工艺,如哑光 / 高光 / 陶瓷盖板 / 玻璃盖板等
- ◆ 高灵敏度设计,高信噪比设计,可获取高清晰度的指纹图像
- ◆ 图像是 8bit 精度, 256 阶灰阶
- ◆ 支持标准 SPI 接口
- ◆ 图像分辨率高达 508DPI
- ◆ 自适应校准:可根据不同指纹自动调整传感器配置
- ◆ 适配模式 / 特征点多种识别算法
- ◆ 无需金属环即可获得高清晰度的指纹图像
- ◆ 支持整机休眠的状态下实现冷屏快速唤醒
- ◆ FRR<2% @ FAR 1/50000

## 电学特性

- ◆ 电源电压 (AVDD): 2.8V~3.6V;
- ◆ 输入 / 输出端口电压 (VDDIO): 1.8V~AVDD;
- ◆ 功耗:
  - Image scan mode (扫描 帧率 > 20 F/s 或自定义): 8.5mA (可配置)
  - Sleep (即手指唤醒前的功耗): 100 $\mu$ A (典型值)
  - Deep sleep mode: 30~100 $\mu$ A

## 可靠性

- ◆ 传感器 ESD 性能
  - 空气放电:  $\pm$ 15.0 kV
  - 接触放电:  $\pm$ 8.0 kV
- ◆ 传感器 Latch-up 性能:
  - $\pm$ 400.0mA

## 电容指纹识别传感器选型

Part. No.	Type	Position	LGA Size / Square	LGA Size / Round	Sensing Size	Pixel Array
GSL6157N	Matte / Glossy Coating	Side-Mounted	14.3*2.4mm		8 x 1.8mm	160 x 36
GSL6159N	Matte / Glossy Coating	Side-Mounted	13.5*2.12mm		8 x 1.6mm	160 x 32
GSL6157R	Matte / Glossy Coating	Curved Side-Mounted	14.3*2.4mm		8 x 1.8mm	160 x 36
GSL6150N	Matte / Glossy Coating	Back-Mounted	Max:12x12mm Min:7.5x7.5mm	Max:φ12mm Min:φ8.5mm	4.0 x 3.2mm	80 x 64
GSL6135N	Matte / Glossy Coating	Back-Mounted	Max:12x12mm Min:7.5x7.5mm	Max:φ12 Min:φ8.5	3.2 x 3.2mm	64 x 64
GSL6182GS1	Matte / Glossy Coating	Smart door lock	Max:15x15mm Min:12.5x12.5mm	Max:φ15mm Min:φ12.5mm	5.7 x 6.6mm	128 x 112
GSL6186	Matte / Glossy Coating	Smart door lock	Max:13x13mm Min:10.5x10.5mm	Max:φ13mm Min:φ10.5mm	6.4 x 3.2mm	128 x 64

## 光学按压式指纹识别传感器特性

- ◆ 屏内指纹识别,支持 OLED 软屏和硬屏
- ◆  $FRR \leq 1.5\% @ FAR \leq 1/50,000$
- ◆ Enroll times  $\leq 12$  次
- ◆ 360 度均可识别



## CCM 传感器

- ◆ 定制化像素电路及工艺设计,以应用于低光照屏下指纹
- ◆ 领先的单芯片架构
- ◆ 定制化镜头设计,与定制像素搭配,获取高清晰度指纹图像
- ◆ 支持无 FLASH
- ◆ 首家在屏下指纹商用 CSP 方案

## 屏下(OLED)光学指纹传感器选型

Part. No.	Finger Touch Size	Pixel Array
GSL7000A	6.0 x 6.0 mm	320 x 320
GSL7001A	6.0 x 6.0 mm	250 x 250
GSL7002A	7.0 x 7.0 mm	200 x 200

# DDR3L

## 产品特点

- ◆ 存储容量：2Gb/4Gb
- ◆ 数据接口：x8/x16 可选
- ◆ 数据速率：最高可达 2133Mbps
- ◆ 温度范围：0~95°C / -40~95°C / -40~105°C
- ◆ 应用领域：网络通信、电视、安防监控、机顶盒、智慧家庭、工业、车载影音等诸多领域
- ◆ 从设计、流片，到封测、验证全国产化





## DDR3L 商规

型号	容量	架构	速率	电压	温度	封装
GDP1A8LM-CB	2Gb	x8	1866Mbps	1.35/1.5V	0~95°C	78-FBGA
GDP1A8LM-CA	2Gb	x8	2133Mbps	1.35/1.5V	0~95°C	78-FBGA
GDP1BFLM-CB	2Gb	x16	1866Mbps	1.35/1.5V	0~95°C	96-FBGA
GDP1BFLM-CA	2Gb	x16	2133Mbps	1.35/1.5V	0~95°C	96-FBGA
GDP2A8LM-CB	4Gb	x8	1866Mbps	1.35/1.5V	0~95°C	78-FBGA
GDP2A8LM-CA	4Gb	x8	2133Mbps	1.35/1.5V	0~95°C	78-FBGA
GDP2BFLM-CB	4Gb	x16	1866Mbps	1.35/1.5V	0~95°C	96-FBGA
GDP2BFLM-CA	4Gb	x16	2133Mbps	1.35/1.5V	0~95°C	96-FBGA

## DDR3L 工规 I

型号	容量	架构	速率	电压	温度	封装
GDP1A8LM-WB	2Gb	x8	1866Mbps	1.35/1.5V	-40~95°C	78-FBGA
GDP1A8LM-WA	2Gb	x8	2133Mbps	1.35/1.5V	-40~95°C	78-FBGA
GDP1BFLM-WB	2Gb	x16	1866Mbps	1.35/1.5V	-40~95°C	96-FBGA
GDP1BFLM-WA	2Gb	x16	2133Mbps	1.35/1.5V	-40~95°C	96-FBGA
GDP2A8LM-WB	4Gb	x8	1866Mbps	1.35/1.5V	-40~95°C	78-FBGA
GDP2A8LM-WA	4Gb	x8	2133Mbps	1.35/1.5V	-40~95°C	78-FBGA
GDP2BFLM-WB	4Gb	x16	1866Mbps	1.35/1.5V	-40~95°C	96-FBGA
GDP2BFLM-WA	4Gb	x16	2133Mbps	1.35/1.5V	-40~95°C	96-FBGA

## DDR3L 工规 II

型号	容量	架构	速率	电压	温度	封装
GDP1A8LM-IB	2Gb	x8	1866Mbps	1.35/1.5V	-40~105°C	78-FBGA
GDP1A8LM-IA	2Gb	x8	2133Mbps	1.35/1.5V	-40~105°C	78-FBGA
GDP1BFLM-IB	2Gb	x16	1866Mbps	1.35/1.5V	-40~105°C	96-FBGA
GDP1BFLM-IA	2Gb	x16	2133Mbps	1.35/1.5V	-40~105°C	96-FBGA
GDP2A8LM-IB	4Gb	x8	1866Mbps	1.35/1.5V	-40~105°C	78-FBGA
GDP2A8LM-IA	4Gb	x8	2133Mbps	1.35/1.5V	-40~105°C	78-FBGA
GDP2BFLM-IB	4Gb	x16	1866Mbps	1.35/1.5V	-40~105°C	96-FBGA
GDP2BFLM-IA	4Gb	x16	2133Mbps	1.35/1.5V	-40~105°C	96-FBGA

# DDR4

## 产品特点

- ◆ 存储容量:4Gb
- ◆ 数据接口:x8/x16 可选
- ◆ 数据速率:最高可达 3200Mbps
- ◆ 温度范围:0~95°C / -40~95°C / -40~105°C
- ◆ 应用领域:机顶盒、电视、安防监控、网络通信、智慧家庭、工业、车载影音等诸多领域
- ◆ 从设计、流片,到封测、验证全国产化



## DDR4 商规

型号	容量	架构	速率	电压	温度	封装
GDQ2A8AA-CE	4Gb	x8	2400Mbps	1.2V	0~95°C	78-FBGA
GDQ2A8AA-CQ	4Gb	x8	2666Mbps	1.2V	0~95°C	78-FBGA
GDQ2A8AA-CJ	4Gb	x8	3200Mbps	1.2V	0~95°C	78-FBGA
GDQ2BFAA-CE	4Gb	x16	2400Mbps	1.2V	0~95°C	96-FBGA
GDQ2BFAA-CQ	4Gb	x16	2666Mbps	1.2V	0~95°C	96-FBGA
GDQ2BFAA-CJ	4Gb	x16	3200Mbps	1.2V	0~95°C	96-FBGA

## DDR4 工规 I

型号	容量	架构	速率	电压	温度	封装
GDQ2A8AA-WE	4Gb	x8	2400Mbps	1.2V	-40~95°C	78-FBGA
GDQ2A8AA-WQ	4Gb	x8	2666Mbps	1.2V	-40~95°C	78-FBGA
GDQ2A8AA-WJ	4Gb	x8	3200Mbps	1.2V	-40~95°C	78-FBGA
GDQ2BFAA-WE	4Gb	x16	2400Mbps	1.2V	-40~95°C	96-FBGA
GDQ2BFAA-WQ	4Gb	x16	2666Mbps	1.2V	-40~95°C	96-FBGA
GDQ2BFAA-WJ	4Gb	x16	3200Mbps	1.2V	-40~95°C	96-FBGA

## DDR4 工规 II

型号	容量	架构	速率	电压	温度	封装
GDQ2A8AA-IE	4Gb	x8	2400Mbps	1.2V	-40~105°C	78-FBGA
GDQ2A8AA-IQ	4Gb	x8	2666Mbps	1.2V	-40~105°C	78-FBGA
GDQ2A8AA-IJ	4Gb	x8	3200Mbps	1.2V	-40~105°C	78-FBGA
GDQ2BFAA-IE	4Gb	x16	2400Mbps	1.2V	-40~105°C	96-FBGA
GDQ2BFAA-IQ	4Gb	x16	2666Mbps	1.2V	-40~105°C	96-FBGA
GDQ2BFAA-IJ	4Gb	x16	3200Mbps	1.2V	-40~105°C	96-FBGA

## 北京兆易创新科技股份有限公司

---

### 北京总部

北京市海淀区丰豪东路9号  
中关村集成电路设计园8号楼  
电话: +86-10-82881666  
传真: +86-10-82881668  
邮箱: info@gigadevice.com

北京市朝阳区安定路5号  
城奥大厦6层  
电话: +86-10-82881666  
邮箱: info@gigadevice.com

### 上海

上海市长宁区兆益科技园区  
天山路18号603室  
电话: +86-21-32567770  
邮箱: info@gigadevice.com

上海市浦东新区张江路505号  
展想中心大厦12-15层  
电话: +86-10-20221991  
邮箱: info@gigadevice.com

### 深圳

深圳市南山区高新南九道10号  
深圳湾科技生态园10栋B座3501  
电话: +86-755-83438655  
邮箱: info@gigadevice.com

### 合肥

合肥市经济技术开发区  
清华路368号  
电话: +86-551-68999899  
邮箱: info@gigadevice.com

### 西安

西安市高新区天谷七路88号  
腾飞科汇城东幢23层  
电话: +86-29-88858591  
邮箱: info@gigadevice.com

### 美国

100 Century Center Ct., Suite 120  
San Jose, CA 95112, USA  
Tel: +001-408-855-8336  
E-mail: info@gigadevice.com

### 英国

Innovation House  
Molly Millars Close, Wokingham  
Berkshire RG41 2RX  
Tel: +44-7585-707-735  
E-mail: info@gigadevice.com

### 德国

GmbH  
Lindwurmstr. 114, 80337 Munich, Germany  
Tel: +49-151-52494892  
E-mail: info@gigadevice.com

### 韩国

217, Yatap Leaders Bld, 42, Jangmi-ro,  
Bundang-gu, Seongnam-si  
Gyeonggi-do 13496, Korea  
Tel: +82-31-701-2408  
E-mail: Robert@gigadevice.com

### 日本

DSM Shin-Yokohama building 2F,  
2-6-3 Shin-Yokohama, Kohoku,  
Yokohama 222-0033  
Tel: +81-45-534-4102  
Fax: +81-45-534-4103  
E-mail: info@gigadevice.com

### 新加坡

5 Tampines Ave 8 #06-05  
Singapore 529596  
Tel: +65-9765-4231  
E-mail: info@gigadevice.com



## X-ON Electronics

Largest Supplier of Electrical and Electronic Components

*Click to view similar products for [32-bit Microcontrollers - MCU category](#):*

*Click to view products by [Gigadevice manufacturer](#):*

Other Similar products are found below :

[MCF51AC256AVFUE](#) [MCF51AC256BCFUE](#) [MCF51AC256BVFUE](#) [MB91F464AAPMC-GSE2](#) [R5S726B0D216FP#V0](#) [MB91F248PFV-GE1](#) [MB91243PFV-GS-136E1](#) [SAK-TC1782F-320F180HR BA](#) [TC364DP64F300WAAKXUMA1](#) [R5F566NNDDFP#30](#)  
[R5F566NNDDFC#30](#) [R5F566NNDDBD#20](#) [MC96F8216ADBN](#) [A96G181HDN](#) [A96G140KNN](#) [A96G174FDN](#) [A31G213CL2N](#)  
[A96G148KNN](#) [A96G174AEN](#) [AC33M3064TLBN-01](#) [V3s](#) [T3](#) [A40i-H](#) [V526](#) [A83T](#) [R11](#) [V851s](#) [A133](#) [V833](#) [F1C100S](#) [T3L](#) [T507](#) [A33](#)  
[A63](#) [T113-i](#) [H616](#) [V853](#) [V533](#) [R16-J](#) [V536-H](#) [A64-H](#) [V831](#) [V3LP](#) [T113-S3](#) [F1C200S](#) [F133-A](#) [R128-S2](#) [D1-H](#) [ADUCM360BCPZ128-TR](#)  
[APT32S003F8PT](#)