

GD32VF Series of RISC-V 32-bit MCUs



GD32VF Series of RISC-V 32-bit MCUs

Overview

GigaDevice Semiconductor has recently launched the world's first open source RISC-V based GD32V series of 32-bit general-purpose MCU products. Within six months after the launch of the GD32VF103 RISC-V core MCU series, it attracted high volumes of interest and won the title for the best hardware product of the year at the Embedded World Exhibition 2020, Germany.

As the first product line of the GD32 MCU family based on the RISC-V core, the new GD32VF103 series RISC-V MCU is designed for the demanding embedded market. While providing a cost-effective solution, the processing performance and features still remain well balanced.

Why RISC-V Architecture?

- A completely open ISA that is freely available to the academia and industry.
- A real ISA suitable for direct native hardware implementation, not just simulation or binary translation.
- An ISA that avoids “over-architecting” for a particular microarchitecture style (e.g. micro-coded, in-order, decoupled, out-of-order) or implementation technology (e.g. full-custom, ASIC, FPGA), but which allows efficient implementation in any of these.
- An ISA separated into a small base integer ISA, usable by itself as a base for customized accelerators or for educational purposes, optional standard extensions and to support general-purpose software development.

GD32VF103 RISC-V General Purpose MCU

The GD32VF103 MCU series adopts the new Bumblebee processor core based on the open source RISC-V instruction set architecture.

The Bumblebee core uses a 32-bit RISC-V open source instruction set architecture and supports custom instructions to optimize interrupt handling. It is not only equipped with a 64-bit wide real-time timer but also it can generate timer interrupts defined by the RISC-V standard, support of dozens of external interrupt sources, while possessing 16 interrupt levels and priorities, interrupt nesting and fast vector interrupts processing mechanism.

Features:

- **RISC-V Bumblebee core at up to 108MHz**
- **Support RV32IMAC instruction set**
- **Two-stage variable length pipeline architecture**
- **Integrated hardware multiplier and divider**
- **Memory**
16 - 128KB Flash, 6 - 32KB SRAM
- **Timers**
1x 16-bit Adv.TM, 4x 16-bit GPTM, 2x 16-bit Bsc.TM
1x 24-bit Systick TM, 2x WDG, 1x RTC
- **Best-in-class peripheral support**
2x UART, 3x USART, 2x I2C, 3x SPI, 2x I2S, 1x USB 2.0 OTG
2x CAN 2.0B, External Memory Controller (NOR Flash, SRAM, PSRAM, ROM)

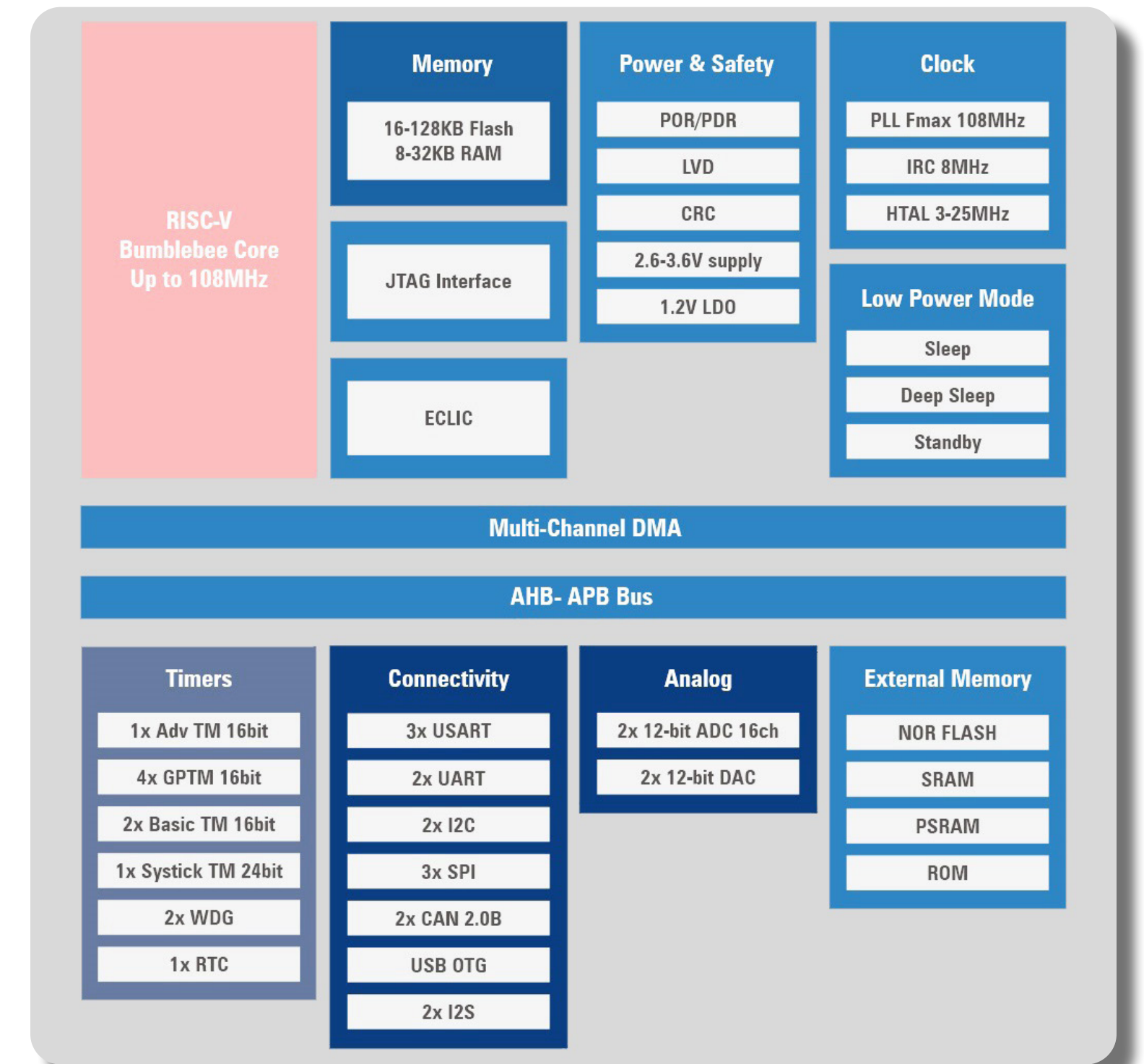

- **Analog peripheral**
2x 12-bit 16ch ADC, 2x 12-bit DAC
High-precision 1MSPS ADC
- **2.6-3.6V supply; 5V tolerance I/Os, up to 80 GPIOs**
- **Three low power consumption modes;**
Sleep, Deep-Sleep, Standby Mode
Standby Current @6.3uA
- **QFN36, LQFP48, LQFP64, LQFP100**

RISC-V Development Ecosystem

GigaDevice is providing a rich and comprehensive support framework, including a variety of development boards and application software for the RISC-V development ecosystem. Users of the GD32V family can easily implement their design ideas, with the new development tools and software libraries.

Software Library

GigaDevice offers the software libraries which include a good variety of example solutions for both the full function evaluation board and starter kits. The users can easily test the functionality of all the peripherals, while they can modify the examples and build their own projects quick and easy.

IDE Support

GigaDevice also cooperates with Nuclei System Technology and third-party partners to provide various IDE's (Integrated Development Environment). This allows users the opportunity to choose the IDE that fits their specific needs. All the IDE's are provided by vendors with years of experience in the field of embedded software development. Examples of these IDE tools include:

- **Nuclei Studio**
- **SEGGER Embedded Studio**
- **IoT Studio**
- **IAR Embedded Workbench**

Debugging Tools

Additionally, GD32 RISC-V MCU users have the option to choose their programming and debugging tools from the world market leaders, SEGGER (J-Link) and IAR (I-Jet) debugging probes. In addition, GigaDevice has their own "in-house" GD-Link debug probe (supports both programming and debugging) and is embedded on all of the GigaDevice range of development boards. It is also available as a separate stand-alone tool.

- **GD-Link**
- **SEGGER J-Link V10**
- **IAR I-Jet**

Full Function EVB & Starter Kit

GigaDevice provides all the hardware tools including the GD32VF103V-EVAL full function evaluation board along with the GD32VF103R-START, GD32VF103C-START and GD32VF103T-START entry-level starter kits.

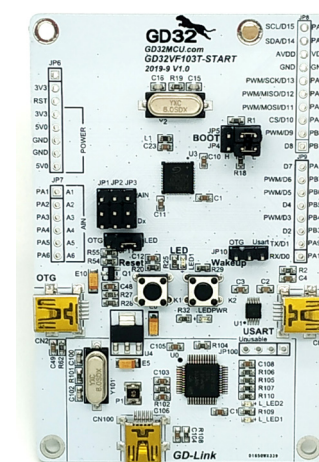
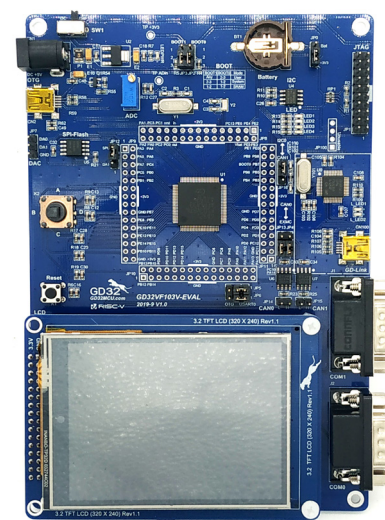

- **GD32VF103V-EVAL**
- **GD32VF103R-START**
- **GD32VF103C-START**
- **GD32VF103T-START**

Demos and Solutions

Moreover, GigaDevice and its partners provide varied application boards based on the GD32VF103 RISC MCU portfolio.

- **GD32VF103-BLDC**
- **GD32VF103-DRONE**
- **GD32VF103-LCD**

This allows to demonstrate the RISC-V technology and demonstrates how well suited they are for the embedded fields of;

- **Industrial**
- **Consumer**
- **IoT**
- **Edge Computing**
- **Artificial Intelligence**
- **Vertical Market**

Operating System

For embedded operating systems such as μ C/OS II, FreeRTOS, RT-Thread, TencentOS-tiny and LiteOS, these are also fully supported and can provide connectivity with the cloud. All of these tools have greatly simplified the development of the GD32 RISC-V based MCU's.

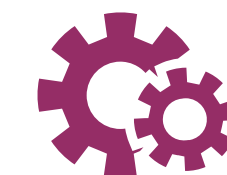

Software Library

- GD32 Library
- Third Party Middleware



IDE Support

- Nuclei Studio
- SEGGER Embedded Studio
- IoT Studio
- IAR Embedded Workbench



Debugging & Programming Tools

- GD-Link
- SEGGER J-Link V10
- IAR I-jet



Full Function EVB & Starter Kit

- GD32VF103V-EVAL
- GD32VF103T-START
- GD32VF103R-START
- GD32VF103C-START



Demos & Solutions

- GD32VF103-BLDC
- GD32VF103-LCD
- GD32VF103-DRONE



Operating System

- Link to Cloud
- FreeRTOS
- μ C/OS II
- LiteOS
- RT-Thread
- TencentOS-tiny

GigaDevice & Third Party Partners Solutions

GigaDevice is a [Silver member of the RISC-V Foundation](#), a member of China RISC-V Alliance and a member of China RISC-V Industry Consortium. GD32 has an extensive and in-depth interaction with global MCU developers and lots of third-party partners to continue to grow the RISC-V MCU ecosystem.



BLDC

- GD32VF103RBT6 on board
- BLDC Square wave control
- Hall Sensors
- Encoder & Comparator

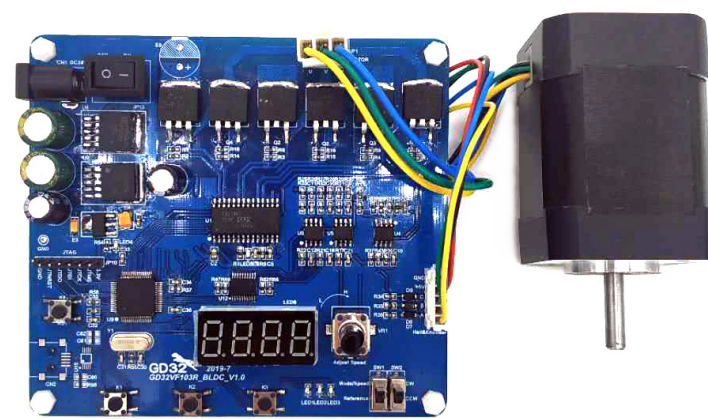

7" LCD Multi touch

- 5 touch points at the same time
- Communication with the main controller through I2C protocol
- GD32VF103C8T6 on board

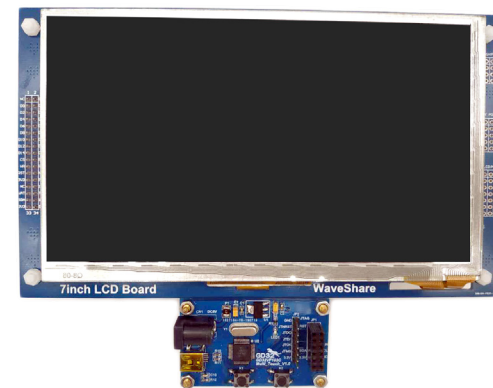

Drone

- Square Wave control
- Maximum motor speed 28000rpm
- 1,176 Million commutation per minute
- GD32VF103C8T6 on board

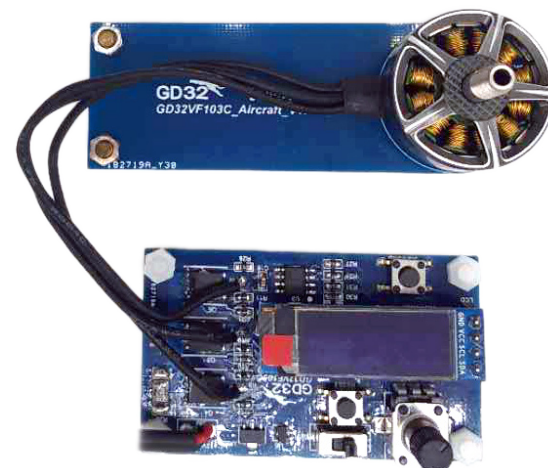

SEGGER's support tools include:

- Embedded Studio integrated development environment for RISC-V
- The market-leading J-Link debug probe
- Ozone debugger
- emPack with the RTOS embOS and Software Libraries.



The SEGGER RISC-V support tools can be found [here](#).



Embedded Workbench IDE, launched by the well-known Swedish software developer IAR Systems.

IAR has also released a RISC-V version which supports the GD32VF103 MCU product series.

The IAR RISC-V support tools can be found [here](#).



The TencentOS-tiny IoT development board is the first RISC-V based IoT learning development board.

It can support Wi-Fi, NB-IoT, 2G and LoRaWAN.

Additionally, it can support E53 sensor expansion for IoT verification solutions.

Example code for the TencentOS-tiny development board can be found on github [here](#).

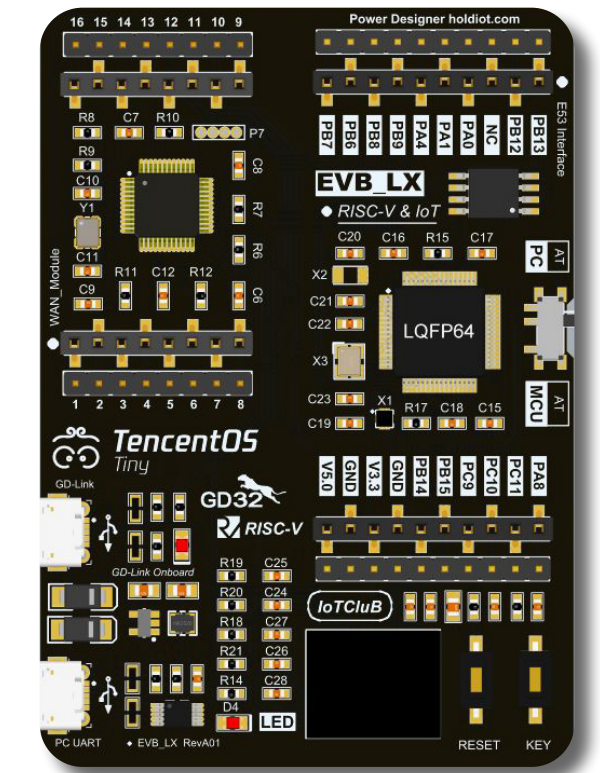

The new SeeedStudio GD32 RISC-V Dev Board equipped with the powerful GD32VF103VBT6 MCU has more I/O resources, onboard flash, communication interfaces, etc...

The board also supports the "TFT eSPI" library and together with an LCD kit it can easily implement various display effects, graphics and lightweight GUI.

The RISC-V kits provided by [Seed](#) are available on Mouser [here](#).

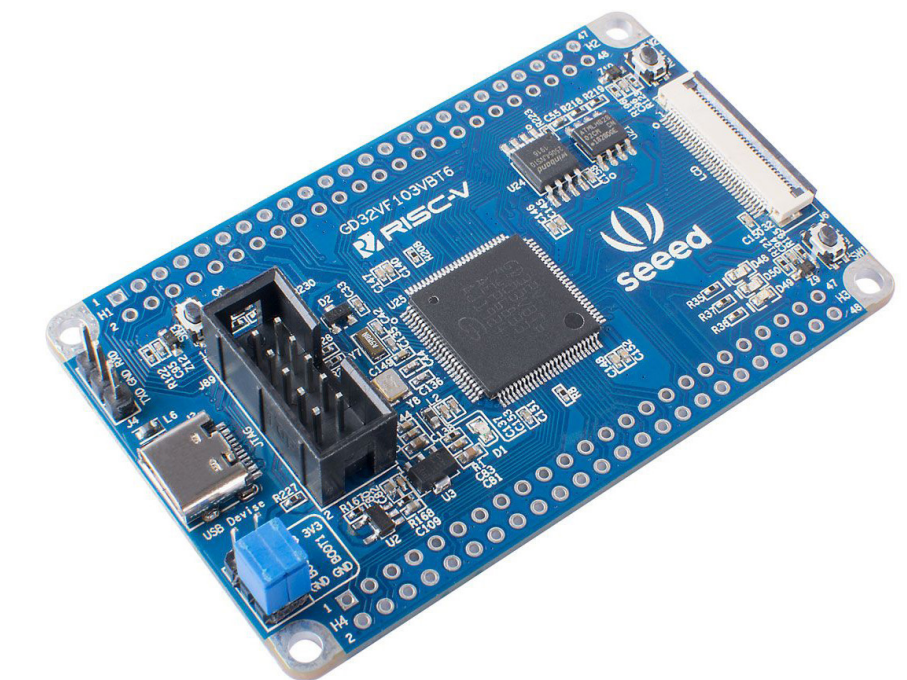

GD32 MCU - Website

GigaDevice welcomes its users to a new and modernized website. www.GD32MCU.com the new website is available in two versions, Chinese and English, while providing complete documentation for all the GD32 MCU products in both languages.



The user can easily move from the Chinese Version to English version by simply clicking the “English Version“ button at the top right corner of the navigation menu.

At the home page there is a navigation menu, Product, News, Solutions, Downloads and language selection items. Below the navigation menu there is a news board with information about events, conferences, exhibitions, shows and forums in which GigaDevice participates in. The user can have access to product news, such as “[GD32VF103 series of RISC-V MCU Quick Start](#)” article, which was written by the famous author Tam Hanna of Elektor online magazine.

Exhibitions & Conferences

GigaDevice participates in university programs across the world, cooperates with university professors, prepares technical training materials and books, organizes student contests, while the GigaDevice experts join efforts with university laboratories and give lectures to the students.

Furthermore, GigaDevice participates in exhibitions and conferences in China and abroad. On February 25-27 2020, the world’s largest embedded system exhibition, the Embedded World 2020, was successfully held in Nuremberg Germany. At the conference, GD32 had an extensive and in-depth interaction with global MCU developers and discussed with new third-party partners to continue to grow their MCU ecosystem.



Additionally, the GigaDevice experts gave an impressive keynote speech to the audience at the Embedded World, introduced the development of the latest RISC-V embedded technology, the RISC-V specifications, provided in-depth explanation about exception handling, interrupt handling, peripheral design and the characteristics of GD32VF103 product series.

Product of the year - External References

The GD32VF103 MCU product series, based on the RISC-V open source ISA (Instruction Set Architecture), has won the award of hardware product of the year at the Embedded World 2020 in Nuremberg Germany.

To read more news about the GD32 MCU, there are many online magazines and media platforms. These include [Embedded World Newsroom](#) (English), [Polyscope](#) (German) and [Channel-e](#) online media platform (German).



Contact Us

More information about all the GigaDevice products can be found at www.gigadevice.com.

For technical support and other requests, please contact ao.li@gigadevice.com.

X-ON Electronics

Largest Supplier of Electrical and Electronic Components

Click to view similar products for [Gigadevice manufacturer](#):

Other Similar products are found below :

[GD25B512MEFIRR](#) [GD25B64ESIGR](#) [GD25D05BTIG](#) [GD25D05CEIGR](#) [GD25D05CTIGR](#) [GD25D10BOIGR](#) [GD25D10CEIGR](#)
[GD25D10CKIGR](#) [GD25D10CTEGR](#) [GD25D10CTIGR](#) [GD25LB256E3IRR](#) [GD25LB64EWIGR](#) [GD25LE128EWIGR](#) [GD25LE64ELIGR](#)
[GD25LQ128ESIGR](#) [GD25LQ16EEIGR](#) [GD25LQ16ENIGR](#) [GD25LQ16SIG](#) [GD25LQ16TIG](#) [GD25LQ32ESIGR](#) [GD25LQ32EWIGR](#)
[GD25LQ40CEIGR](#) [GD25LQ40CTIGR](#) [GD25LQ64ENIGR](#) [GD25LQ64ESIGR](#) [GD25LQ80CEIGR](#) [GD25LQ80ETIGR](#) [GD25Q128EFIRR](#)
[GD25Q128ESIG](#) [GD25Q128EWIGR](#) [GD25Q16CSJGR](#) [GD25Q16EEIGR](#) [GD25Q16ESIG](#) [GD25Q16ESIGR](#) [GD25Q20CEIGR](#)
[GD25Q20CTIGR](#) [GD25Q32CSJGR](#) [GD25Q32ESIG](#) [GD25Q32ESIGR](#) [GD25Q32ETIGR](#) [GD25Q40CEIGR](#) [GD25Q40CEJGR](#)
[GD25Q40CSIGR](#) [GD25Q40CTIGR](#) [GD25Q64CSJGR](#) [GD25Q64CYIGR](#) [GD25Q64ESIG](#) [GD25Q64ESIGR](#) [GD25Q64EWIGR](#)
[GD25Q80EEIGR](#)