

产品承认书

PRODUCT SPECIFICATIONS

客 户
CUSTOMER:

产 品 名 称 网络变压器
PART NAME: (10/100 BASE TRANSFORMER)

产 品 型 号
PART NUMBER: GBHB16M-351Z01

客 户 型 号
CUSTOMER'S PART:

承认书编号
REF NO:

日 期
DATE: 2023-03-02

版本/版次
REV/NO: A/0

公司承认 COMPANY APPROVAL		
制作 PREPARED BY	审核 CHECKED BY	批准 APPROVED BY
张添来	张立华	吴显峰

客户承认 CUSTOMER APPROVAL	
批准签字 APPROVED SIGNATURES	



深圳市格莱尔电子有限公司
Shenzhen Glorious Electronic

公司地址: 深圳市宝安区固戍华丰智谷航程高科技产业园A2栋228室
TEL: 0755-27815501 FAX: 0755-27815500
Http: //www.glecorp.com



A. ELECTRICAL SPECIFICATIONS @25 °C

OCL:350uH Min @ 100KHz,0.1V,8mA DC BIAS

LL:0.5uH Max @100KHz,0.1V

Cw/w:28PF TYP @100KHz,0.1V

DCR:1.2 Ω Max 16-14,11-9

Turn Ratio:1CT:1CT(TX)/1CT:1CT(RX)±3%

Polarity:1-16,6-11 In-Phase

Insertion Loss : 0.5-100MHz -1.1dB Max(TX/RX)

Return Loss : 0.5-30MHz -18dB Min(TX/RX)

30.1-60MHz -18+20log(f/30)dB Min

60.1-80MHz -12dB Min

Cross Talk: 0.5-40MHz -35dB Min

40.1-100MHz -33+20log(f/50)dB Min

CMRR: 0.5-100MHz -30dB Min

Isolation Hi-Pot:1650Vrms 1mA 3S

OPERATING TEMPERATURE:-40 °C TO 85 °C.

Product Type: Green Product

B. SCHEMATIC:

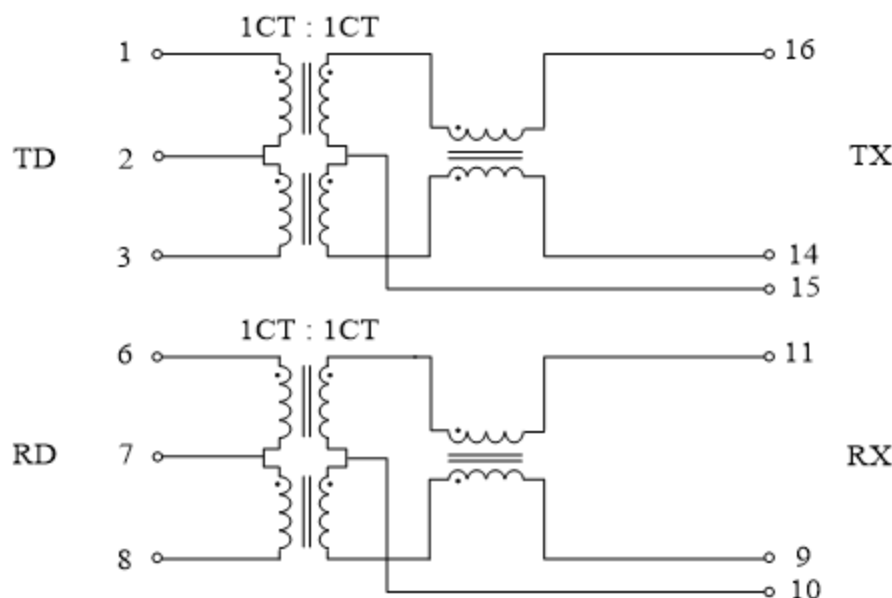

DRAWN BY	CHECKED BY	APPROVED BY	CUSTOMER:	DATE	2023-3-2
张添来	张立华	吴显峰	PART NO: GBHB16M-351Z01	PAGE	1 OF 3

C. DIMENSIONS & MARKING:

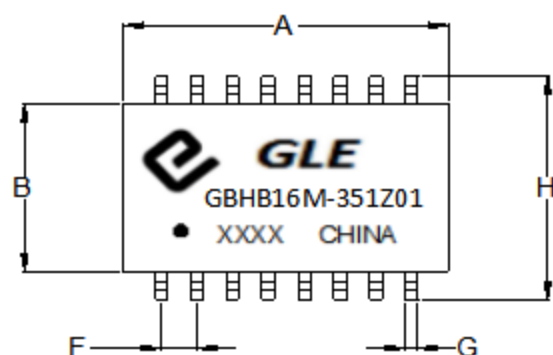

YYWW:Date Code

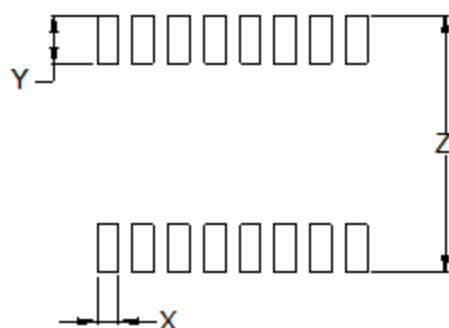

Suggested Pad layout

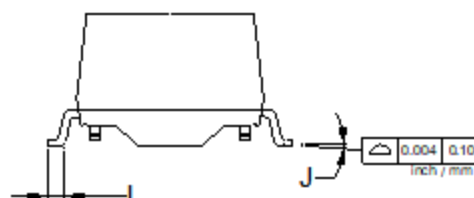

DIM	MILLIMETERS		INCHES	
	Center	Tolerances	Center	Tolerances
A	12.80	± 0.254	0.504	± 0.010
B	6.90	± 0.254	0.272	± 0.010
C	6.0(max)		0.236(max)	
D	8.89	± 0.127	0.350	± 0.005
E	0.30	± 0.127	0.012	± 0.005
F	1.27	± 0.127	0.050	± 0.005
G	0.46	± 0.127	0.018	± 0.005
H	9.40	± 0.300	0.370	± 0.012
I	4°	± 4°	0.157	± 0.157
J	0.70	± 0.254	0.028	± 0.010
X	0.76(typical)		0.024(typical)	
Y	2.03(typical)		0.074(typical)	
Z	10.67(typical)		0.420(typical)	

DRAWN BY	CHECKED BY	APPROVED BY	CUSTOMER:	DATE	2023-3-2
张添来	张立华	吴显峰	PART NO: GBHB16M-351Z01	PAGE	2 OF 3

G. PACKAGE CRITERION:

1. Inner Carton: 335*340*40

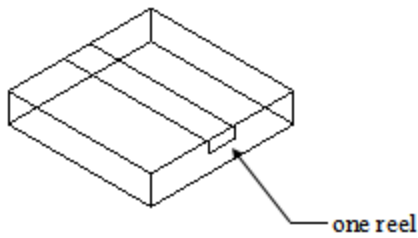

2. Export Carton: 400*400*270

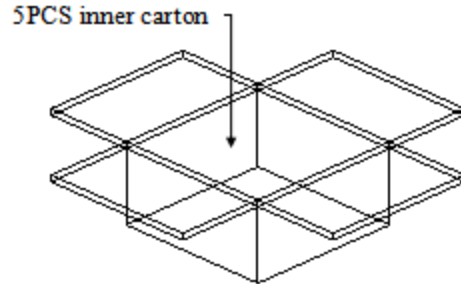

3. Reel:

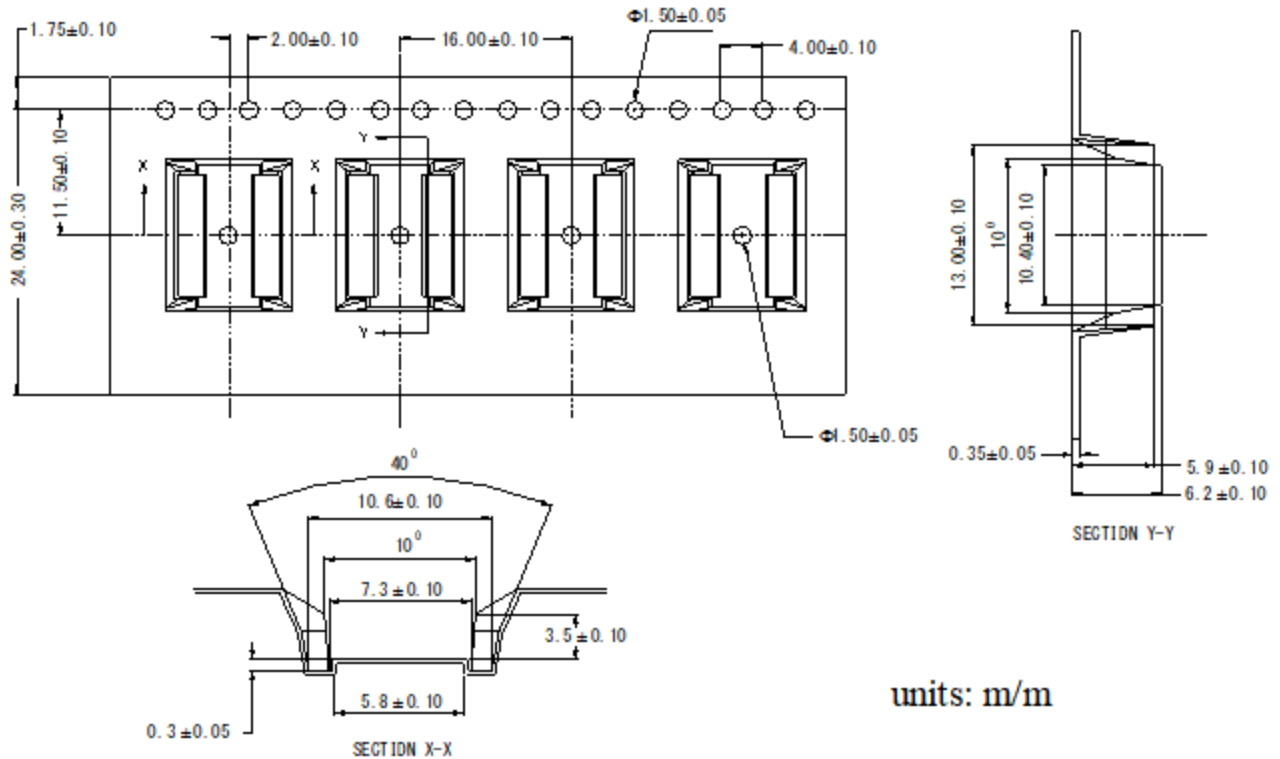
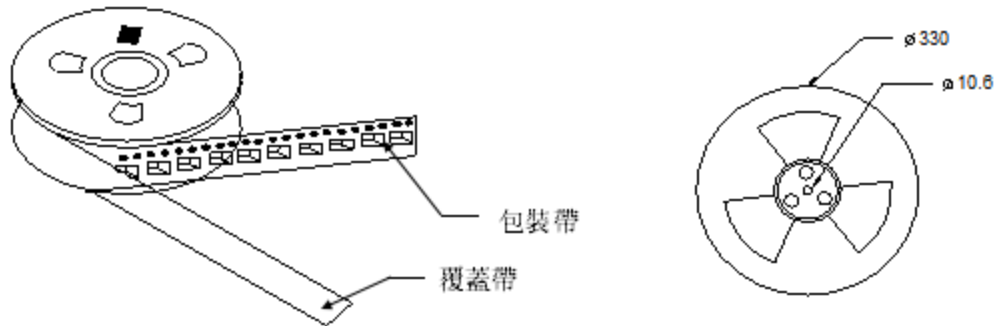

units: m/m

4. Package Quantity:

One Reel=600Pcs

One carton =4800Pcs

DRAWN BY	CHECKED BY	APPROVED BY	CUSTOMER:	DATE	2023-3-2
张添来	张立华	吴显峰	PART NO: GBHB16M-351Z01	PAGE	3 OF 3

X-ON Electronics

Largest Supplier of Electrical and Electronic Components

Click to view similar products for [Audio Transformers](#) / [Signal Transformers](#) category:

Click to view products by [GLE manufacturer](#):

Other Similar products are found below :

[CU4S0506AT-2655-H1](#) [MGPWT-00449-P](#) [PE-64961](#) [1812WBT2-4](#) [BX1194WNL](#) [1879479-1](#) [PA1528ANL](#) [T1137NLT](#) [T3012NL](#) [PE-65848FNLT](#) [H5019EFNL](#) [CX2045ALNLT](#) [MET-14](#) [MGPWT-00059-P](#) [MGPWT-00266-P](#) [MGPWT-00278-P](#) [MGPWT-00431-P](#) [TTC-100](#) [TTC-143-H](#) [TTC-5032-1](#) [4-1879391-0](#) [100213](#) [T1142NL](#) [T1124NL](#) [1879732-1](#) [2-1879391-5](#) [B8846NL](#) [MABA-010321-CT1A42](#) [TX1341NL](#) [H0013FNL](#) [H5020FNL](#) [H2009FNLT](#) [H5004NLT](#) [S553-5999-52-F](#) [T5008NLT](#) [PE-68517T](#) [TG111-E212NWLFR](#) [H5014FNLT](#) [TX1473NLT](#) [PE-69011NLT](#) [CX2043LNLT](#) [H7137FNLT](#) [H1259NLT](#) [TX1344NLT](#) [LM-LP-1005L](#) [H0013NLT](#) [S558-5500-JV](#) [TX1193NLT](#) [T7015NL](#) [T1124NLT](#)