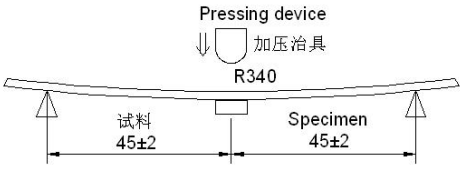
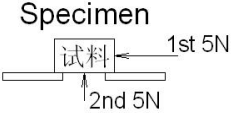

<b>承认书 Specifications</b>		型 名 Type		<b>GCRH73</b>
		GLE 部品型号 GLE Part NO.		<b>GCRH73 系列</b>
接受 Accepted by		客户部品型号 Customer's Part No.		
外形寸法 Physical dimensions			单位 Unit: mm	<b>RoHS Comp.</b>
<b>备注：黑色印字</b>				
<b>使用材料 Materials</b>				
NO.	构成部品 Components	材质 Materials		原产国 Country of origin
1	磁性材料 Magnetic powder	镍锌铁氧体磁粉 Nickel zinc ferrite magnetic powder		中国 China
2	铜线 Wire	改良聚胺脂涂布铜线 Polyurethane-system coated copper wire		德国 Germany
3	胶水 epoxy	环氧树脂 Phenolic epoxy resin		中国 China
4	电极 Electrode	铜镀锡 Tinned copper		中国 China
Issued	2019.09.21			
记号 Symbol	日期 Date	页 Page	变更内容 Contents of revision	确认 Check
	<b>深圳市格莱尔电子有限公司</b>		承认者 Approved by	审查者 Checked by
	Shenzhen Glorious Electronic Co.,Ltd. TEL: 0755-27815501-5503 / 29305001-5003 FAX: 0755-27815500 / 29305500		张立华	张顺钧
				担当者 Made by
				刘子善

## GCRH73 Type 一般规格 General Specifications (1/3)

项目 Item	规格 Specification	条件 Condition
1	弯曲测试 <b>Bending test</b>  Change from an initial value L : within $\pm 10\%$	试件焊接在基板上，按箭头方向以大约 0.5mm/秒的速度加压，直到基板变形幅度到 3mm 保持 30 秒。 Apply pressure gradually in the direction of the arrow at a rate of about 0.5mm/s until bent depth reaches 3mm and hold for $30 \pm 5s$ .  
2	固着强度 <b>Adhesion strength</b>  Change from an initial value L : within $\pm 10\%$	按箭头方向用 R0.5 的加压棒在试件中施加一定的静力并保持 $60 \pm 5$ 秒。 A static load using a R0.5 pressing tool shall be applied the arrow and to the body of the specimen in the direction of the arrow and shall be hold for $60 \pm 5s$ . Measure after removing pressure.  
3	耐振性 <b>Vibration</b>  Change from an initial value L : within $\pm 10\%$	振动频率 10~55~10Hz，振幅 1.5mm，分 X, Y, Z 方向各振动 2 小时（共 6 小时）。 The specimen shall be subjected to a vibration of 1.5mm amplitude, sweep frequency 10~55Hz (10Hz to 55Hz to 10Hz in a period of one minute) for 1 h in each of 3(X,Y,Z) axes.
4	耐冲击性 <b>Mechanical shock</b>  Change from an initial value L : within $\pm 10\%$	利用橡胶块式落下冲击试验机，分别在 3 个互相垂直的方向以 $981 \text{ m/S}^2$ 的冲击加速度落下。 Peak acceleration: $981 \text{ m/S}^2$ Duration of pulse: 6ms 3 times in each of 3(X,Y,Z) axes. The specimen must be fixed on test board. Three successive shock shall be applied in the perpendicular direction of each surface of the specimen.
5	自然落下试验 <b>Free fall test</b>  Change from an initial value L : within $\pm 10\%$	试件安装在基板上，并固定在重 500 克的盒中，由 1 米高自由落体，3 个互相垂直的方向各 3 次。 The specimen must be fixed on test board. It must be equipped with instruments of which weight is 500g. Then it shall be fallen freely from 1m height to rigid wood 3 times in each of three axes.
6	焊锡附着性 <b>Solder ability</b>  90% 以上的面积要被覆盖。 New solder shall cover 90% minimum of the surface immersed.	试验品的电极深布松香后，在 5~10 秒内焊锡，焊锡槽温度 $245 \pm 5^\circ\text{C}$ ，时间： $3 \pm 0.5$ 秒。 Terminals shall be immersed for 5 to 10 seconds in flux at room temperature. Dip sample into solder bath containing molten solder at $245 \pm 5^\circ\text{C}$ for $3 \pm 0.5$ seconds.
7	焊锡耐热性 <b>Resistance to soldering heat</b>  Change from an initial value L : within $\pm 10\%$	<b>试验方法 Test method</b> 热风炉焊接 Reflow soldering method 预热 Preheat $150 \sim 180^\circ\text{C}$ $90 \pm 30s$ 峰值温度 Peak temp $260^\circ\text{C}$ ( $230^\circ\text{C min}$ , $30 \pm 10s$ ) 试验板的厚度 0.8mm 上按上面条件通过两次热风炉。 The specimen shall be subjected to the reflow process under the above condition 2 times. Test board shall be 0.8mm thick. Base material shall be glass epoxy resin.  <b>测定 Measurement</b> 常温常湿中放置于 1 小时以上测试。 The specimen shall be stored at standard atmospheric conditions for 1 h in prior to the measurement.

**GCRH73 Type 一般规格 General Specifications (2/3)**

	项目 Item	规格 Specification	条件 Condition
8	耐电压 Dielectric strength	没有损害。 Without damage.	在电极与磁材之间加入直流电压 100V 通电时间 1 分钟。 100V DC shall be applied for 60s between the terminal and the core.
9	绝缘抵抗 Insulation resistance	100MΩ 以上 100MΩ or more.	在电极与磁材之间加入直流电压 100V。 100V DC shall be applied between the terminal and the core.
10	耐寒性 Low temperature	Change from an initial value L : within ± 10%	在温度-40±3℃中放置 500±12 小时后, 常温常湿中放置 1 小时以上 2 小时以内测试。 After stored at a temperature of -40 ± 3℃ for 500 ± 12h. The specimen should be measured, then it should be measured under normal temperature and humidity in 1h~ 2h hours.
11	耐热性 Dry heat	Change from an initial value L : within ± 10%	在温度 85±2℃中放置 500±12 小时后, 常温常湿中放置 1 小时以上 2 小时以内测试。 The specimen shall be stored at a temperature of 85 ± 2℃ for 500± 12h. Then it shall be stabilized under standard atmospheric conditions for 1 h before measurement. Measurement shall be made within 1h~ 2h.
12	耐湿性 Dump heat	Change from an initial value L : within ± 10%	在温度 60±2℃, 湿度 90~95%中放置 500±12 小时后, 常温常湿中放置 1 小时以上 2 小时以内测试。 The specimen shall be stored at a temperature of 60 ± 2℃ with relative humidity of 90 ~ 95% for 500 ± 12h. Then it shall be stabilized under standard atmospheric conditions for 1 h before measurement. Measurement shall be made within 1h~ 2h.
13	温度循环 Temperature cycle	Change from an initial value L : within ± 10%	以温度-40℃中放置 30 分钟, 在 85℃放置 30 分钟, 中间转换时间不超过 2 分钟为一个循环。完成 500 个循环后, 常温常湿中放置 1 小时以上 2 小时以内测试。 The specimen shall be measured after to 500 continuous cycles of temperature change of -40℃ for 30 min and 85℃ for 30 min with the transit period of 2min or less. Then it shall be stabilized under standard atmospheric conditions for 1 h before measurement. Measurement shall be made within 1h~ 2h.
14	温度特性 Temperature drift	Inductance temperature coefficient 2000 ppm/℃ or less	在温度-25~+ 85℃之间测试。 To be measured in the range of -25℃ to 85℃.
15	使用温度范围 Operating temperature range	-40 ~ + 125℃	包括制品的发热温度。 Products heating tempratne.
16	保存温度范围 Storage temperature range	-40 ~ + 85℃ *(-40 ~ + 60℃)	在包装的状态下。 In packing state.

**标准状态 Standard atmospheric conditions**

Unless otherwise specified, the standard range of atmospheric conditions in making measurements and test as follows;

Ambient temperature : 5℃ to 35℃, Relative humidity: 45% to 85%, Air pressure: 86kPa to 106kPa

If more strict measurement is required, measurement shall be made within following limits;

Ambient temperature : 20±2℃, Relative humidity: 65±5%, Air pressure: 86kPa to 106kPa

# GCRH73 Type 一般规格 General Specifications (3/3)

## 条件 Reflow soldering condition

- 1 回数: 2 回
- 2 Reflow times: 2times max
- 3 We recommend infrared ray as heat source of reflow bath.
- 4 However halogen lamp shall be used, side heat will be beyond range of resistance heat, so we can't recommend it.

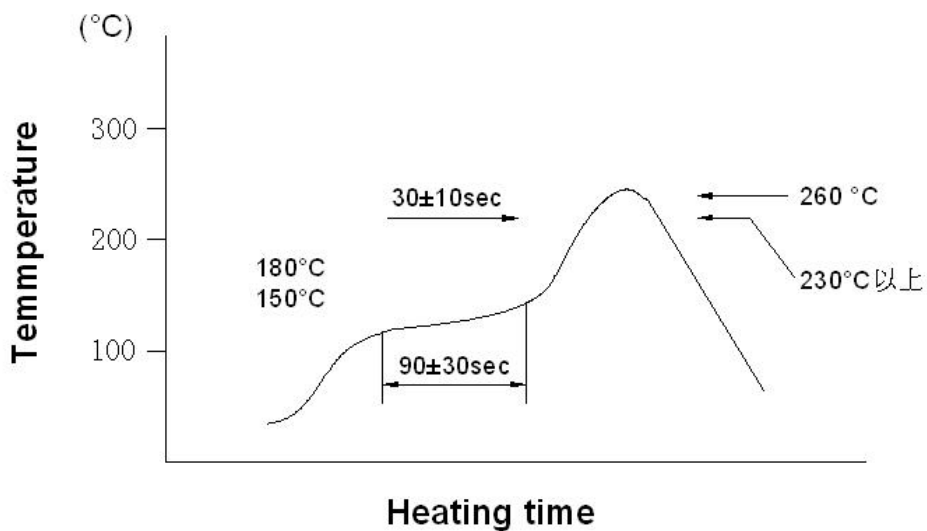

## 推荐焊盘寸法 Recommended PCB pattern

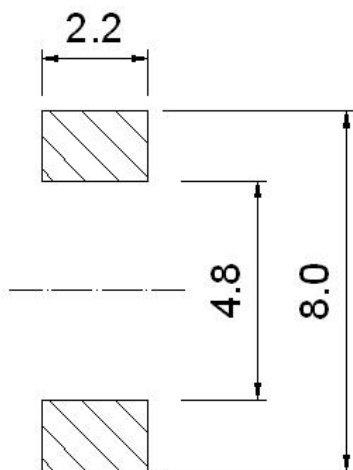

单位 Unit: mm

**GCRH73 个别规格 Part Specifications**

客户部品型号 Customer's Part No.	GLE 部品型号 GLE Part NO.	中心 InductanceLo (uH)	测定频率 Test Frequency (Hz/v)	直流阻抗 DC Resistance (mΩ) max.	饱和电流 Isat (A) Max. △L/L ≧ -35%
	GCRH73-2R2NC	2.2	1KHz/0.25v	27	4.50
	GCRH73-3R3NC	3.3	1KHz/0.25v	31	4.00
	GCRH73-4R7NC	4.7	1KHz/0.25v	48	3.50
	GCRH73-5R6NC	5.6	1KHz/0.25v	56	3.00
	GCRH73-6R8MC	6.8	1KHz/0.25v	62	2.00
	GCRH73-100MC	10	1KHz/0.25v	72	1.68
	GCRH73-120MC	12	1KHz/0.25v	98	1.52
	GCRH73-150MC	15	1KHz/0.25v	130	1.33
	GCRH73-180MC	18	1KHz/0.25v	140	1.20
	GCRH73-220MC	22	1KHz/0.25v	190	1.07
	GCRH73-270MC	27	1KHz/0.25v	210	0.96
	GCRH73-330MC	33	1KHz/0.25v	240	0.91
	GCRH73-390MC	39	1KHz/0.25v	320	0.77
	GCRH73-470MC	47	1KHz/0.25v	360	0.76
	GCRH73-560MC	56	1KHz/0.25v	470	0.68
	GCRH73-680MC	68	1KHz/0.25v	520	0.61
	GCRH73-820MC	82	1KHz/0.25v	690	0.57
	GCRH73-101MC	100	1KHz/0.25v	790	0.50
	GCRH73-121MC	120	1KHz/0.25v	890	0.49
	GCRH73-151MC	150	1KHz/0.25v	1270	0.43
	GCRH73-181MC	180	1KHz/0.25v	1450	0.39
	GCRH73-221MC	220	1KHz/0.25v	1650	0.35
	GCRH73-271MC	270	1KHz/0.25v	2310	0.32
	GCRH73-331MC	330	1KHz/0.25v	2620	0.28
	GCRH73-391MC	390	1KHz/0.25v	2940	0.26
	GCRH73-471MC	470	1KHz/0.25v	4180	0.24
	GCRH73-561MC	560	1KHz/0.25v	4670	0.22
	GCRH73-681MC	680	1KHz/0.25v	5730	0.19
	GCRH73-821MC	820	1KHz/0.25v	6540	0.18
	GCRH73-102MC	1000	1KHz/0.25v	9440	0.16

**Note:**

许容公差 Inductance Tolerance : (特性以实物为准)

 J = ±5% K = ±10% L = ±15% M = ± 20% N = ±30%

# GCRH73 捆包规格 Packing Specifications

Unit : mm

## 1. 寸法 Tape Dimensions

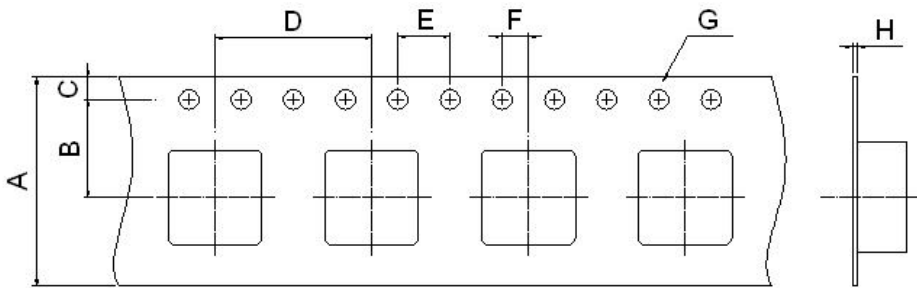

A	16.0
B	7.50
C	1.75
D	12.0
E	4.00
F	2.00
G	Ø1.50
H	0.40

## 2. 方法 Taping method 冷封 (The direction shall be seen from the top cover tape side.)

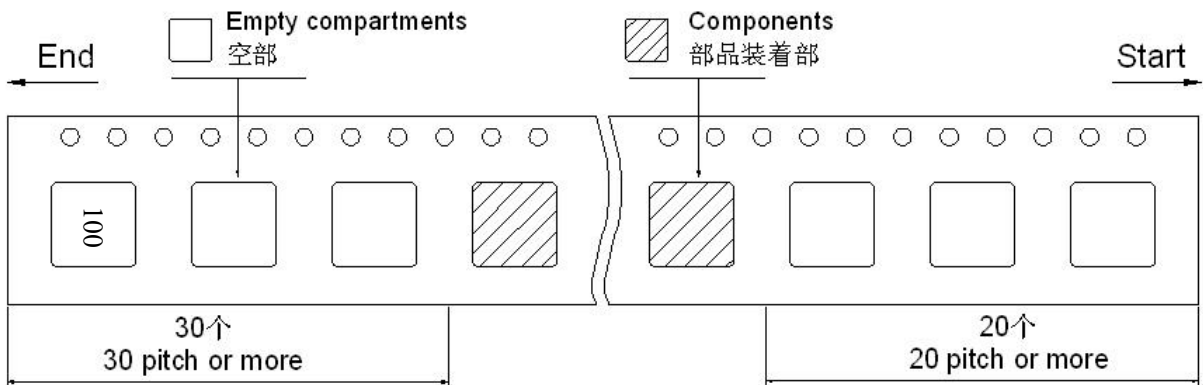

## 3. 卷盘寸法图 Reel dimensions

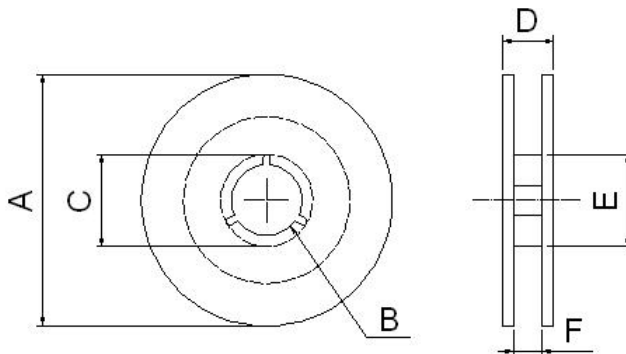

A	330.0
B	Ø13.0
C	21.0
D	20.4
E	100
F	16.4

## 4. 捆包箱 Packing box

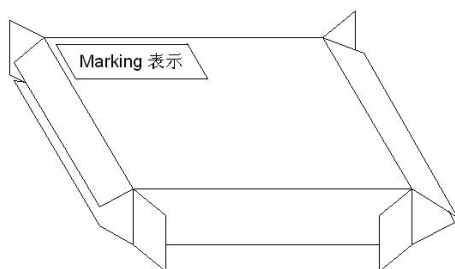

- 捆包箱材质 Packing case material  
纸 Kraft paper
- 收纳数 Real quantity per packing box  
3reel / 1box
- 数量/ 卷 Quantity : 1000PCS / reel
- 表示 Marking  
客户部品型号, 数量, Lot No.  
Customer's part number, Quantity, Lot number.

## 禁用物质 Prohibited Substances

### 1. RoHS 规制的六种物质

- |            |                                     |
|------------|-------------------------------------|
| 1) 铅及其化合物  | Lead and its compounds              |
| 2) 水银及其化合物 | Mercury and its inorganic compounds |
| 3) 镉及其化合物  | Cadmium and its compounds           |
| 4) 六价铬化合物  | Hexavalent chromium compounds       |
| 5) 多溴联苯    | PBB                                 |
| 6) 多溴二苯醚   | PBDE                                |

### 2. 破坏臭氧层的化学物质使用限制

#### PROHIBITION TO USE OZONE DEPLETING SUBSTANCES (ODS)

- | 限制性物质          | Prohibited substances               |
|----------------|-------------------------------------|
| 1) 氟氯化碳        | CFCS                                |
| 2) 氟哌丁苯        | Halon                               |
| 3) 四氯化碳        | Carbon tetrachloride                |
| 4) 三氯乙烯 (三氯乙烷) | Trichloroethane (Methy1 chloroform) |

我公司保证我司的产品和生产过程符合“RoHS 规则”，所有产品中使用的材料均是化学物质生产规则中登记的材料。

We confirm that our products and our production process accord with "rule of RoHS". All materials used in this product are registered material under Regulation of Manufacture of Chemical Substances.

## X-ON Electronics

Largest Supplier of Electrical and Electronic Components

*Click to view similar products for [Fixed Inductors](#) category:*

*Click to view products by [GLE](#) manufacturer:*

Other Similar products are found below :

[MLZ1608M6R8WTD25](#) [MLZ1608N6R8LT000](#) [MLZ1608N3R3LTD25](#) [MLZ1608N3R3LT000](#) [MLZ1608N150LT000](#)

[MLZ1608M150WTD25](#) [MLZ1608M3R3WTD25](#) [MLZ1608M3R3WT000](#) [MLZ1608M150WT000](#) [MLZ1608A1R5WT000](#)

[MLZ1608N1R5LT000](#) [B82432C1333K000](#) [PCMB053T-1R0MS](#) [PCMB053T-1R5MS](#) [PCMB104T-1R5MS](#) [CR32NP-100KC](#) [CR32NP-](#)

[151KC](#) [CR32NP-180KC](#) [CR32NP-181KC](#) [CR32NP-1R5MC](#) [CR32NP-390KC](#) [CR32NP-3R9MC](#) [CR32NP-680KC](#) [CR32NP-820KC](#)

[CR32NP-8R2MC](#) [CR43NP-390KC](#) [CR43NP-560KC](#) [CR43NP-680KC](#) [CR54NP-181KC](#) [CR54NP-470LC](#) [CR54NP-820KC](#) [CR54NP-8R5MC](#)

[ET3542-057](#) [MGDQ4-00004-P](#) [MGDU1-00016-P](#) [MHL1ECTTP18NJ](#) [MHL1JCTTD12NJ](#) [PE-51506NL](#) [PE-53601NL](#) [PE-53630NL](#) [PE-](#)

[53824SNLT](#) [PE-62892NL](#) [PE-92100NL](#) [PG0434.801NLT](#) [PG0936.113NLT](#) [PM06-2N7](#) [PM06-39NJ](#) [HC2LP-R47-R](#) [HC2-R47-R](#) [HC3-2R2-](#)

[R](#)