



INDUSTRIAL STRENGTH

CONNECTOR CONTACTS

FOR MIL-DTL-5015 (VG95234) AND MIL-DTL-26482 (VG95328) TYPE CONNECTORS

AUGUST 2016

CONNECTOR CONTACTS

IT - ITS - ITS-RG - ITZ Connectors

Series Presentation



A

Contacts in this chapter can be used for the following circular connector series:

IT, ITZ, ITS and **ITS RG.**



Threaded **IT** series have been designed to be fully conform to all material and performance requirements of MIL-DTL-5015 specification. IT circular connectors, designed and used in the military market have wide applications in today's industry where strength, reliability and ease of availability in other countries is essential.



ITZ presents same characteristics of IT series except for a special trapezoidal threading system, assured by a rubber o-ring that makes it an excellent choice for amphibious military vehicles and railway applications.

The Glenair Series **ITS** and ITS-RG connector series are based on the MIL-DTL-5015 standard, but feature an improved reverse bayonet coupling technology in place of the threaded coupling used in MIL-DTL-5015. The 3-point bayonet coupling mechanism reduces coupling time and provides easier mating when the connector is in an awkward position. Positive locking of the three stainless steel pins provides reliable resistance to vibration and shock, and prevents connector de-coupling in even the most rugged applications such as locomotives, mass-transit cars and military vehicles.



The **ITS-RG** Series incorporates a ruggedized outer coating of rubber for additional mechanical strength and to prevent shell damage due to rough handling.

Supported contact types include solder, crimp, and PCB versions in both gold or silver surface platings. Standard materials are Copper Alloys (Brass) or High Conductivity Copper Alloys (eg. CuTe) according to capacity or customer request anyway. Special parts of them are made by special material too, as well for special applications we develop dedicated platings. Thermocouple contacts are also available.



CONNECTOR CONTACTS IT - ITS - ITS-RG - ITZ Connectors



Contact Retention System

A

*ITS Series Example
Wall Mount Receptacle*

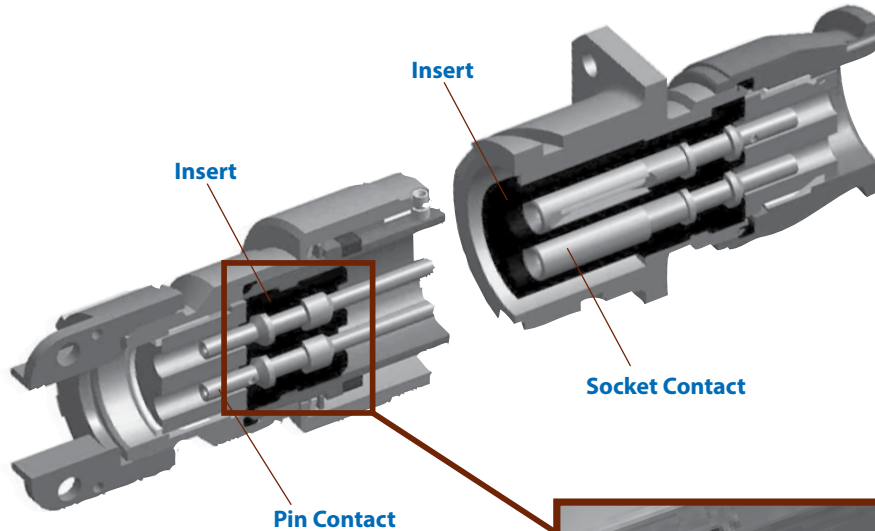

*ITS Series Example
Straight Plug*

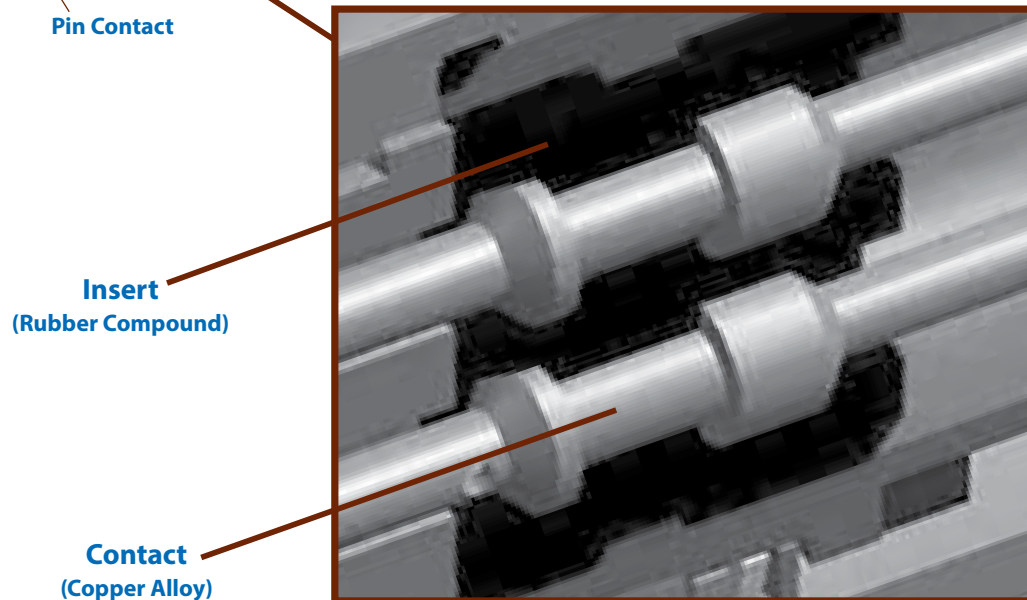

All our connector series IT, ITS, ITS-RG and ITZ, that are based on MIL-DTL-5015 and VG95234 military standards, have a special insert in synthetic rubber that hold in place the contacts.

In fact the contact is maintained in its position thanks to:

- The mechanical interference between contact and insert surfaces profiling
- The mechanical friction between metal contact and rubber insert materials

Retention force for each contact part number, male or female, is according the above specifications, validated during connector qualification phase and periodically checked.

CONNECTOR CONTACTS IT - ITS - ITS-RG - ITZ Connectors



Contact Mating Types

For these contact series we can offer different types of mating technologies between pin and socket. According size, ampacity, contact material or specific customer request, there are four types of socket mating end style as per the drawings below.

Pin contact maintain instead always the same configuration/design.

A



Socket Contact
Internal Clip Type
Standard for Size 20



Socket Contact
Pencil Clip Type
Standard for Size 16 and 12



Socket Contact
Tulip Pressure Member With Hood
Standard from Size 8 to 4/0



Socket Contact
Louver Band
Optional from Size 4 to 4/0



Pin Contact
Standard Configuration
From Size 22 to 4/0

Please consult our Sales Department for other options.

Contact Electrical Performances

A

CURRENT RATING AND CONTACT RESISTANCE TABLE

Contact Size	Current Rating ¹		Max. Contact Resistance (mΩ)
	A @ 20°C ²	A @ 80°C	
20	7.5	7.5	12.0
18	10	7.5	12.0
16	22	13	6.0
12	41	23	3.0
8	73	46	1.0
4	135	80	0.5
0	245	150	0.3
4/0	350	225	0.2

Note . Indicated temperatures are the temperature of the ambient/air where the connector is placed, at "connector power" OFF.

CURRENT RATING GRAPHIC (DERATING CURVES)

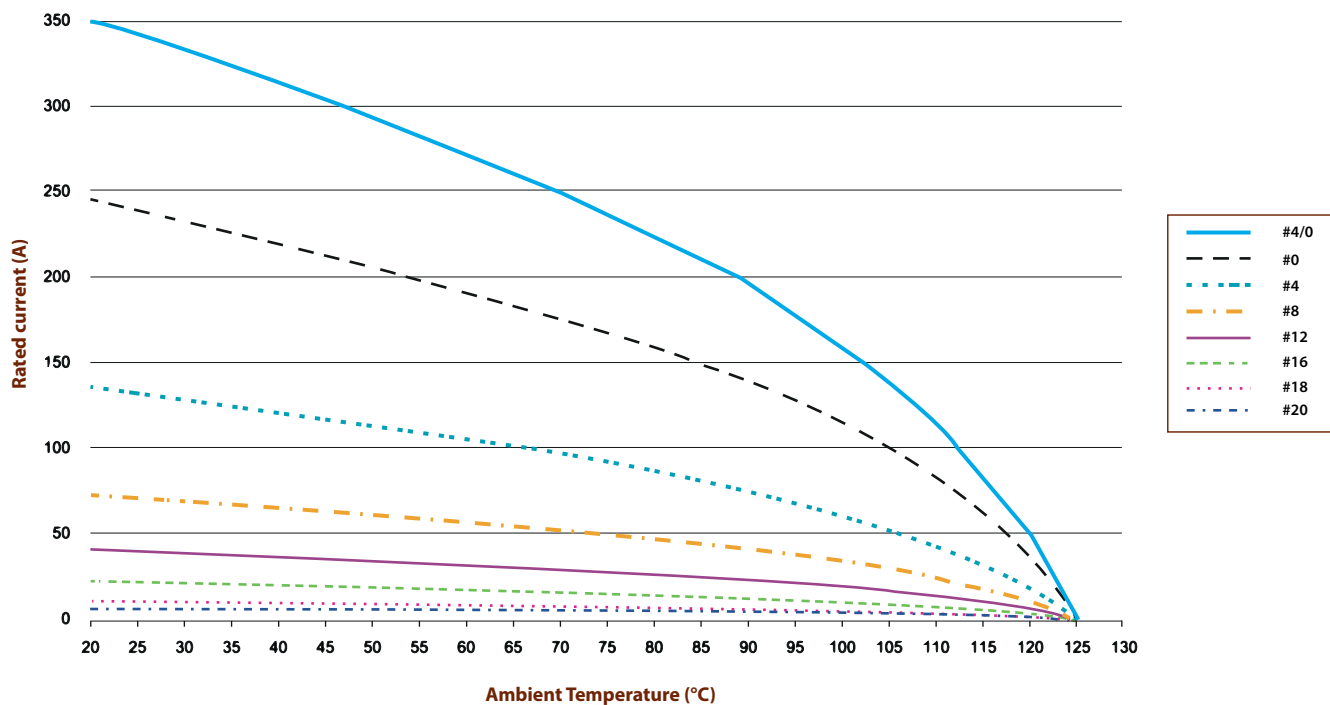

Contacts - Material, Plating and Type

MATERIAL AND PLATING

Contact Size	Material	Plating	
		Standard	Optional
20 - 16 - 12 - 8	Copper Alloy (CuZn)	Silver	Gold or Heavy Gold
4 - 0 - 2/0 - 4/0	High Conductivity Copper Alloy (CuTe)		

A

MATERIAL

Signal and Power Contacts

Choice of body material for the contacts is generally driven by two main factors:

- Current rate
- Connection type between wire and contact (solder or crimp)

What in the table above is the standard for us, changes can be discussed with the customer.

Thermocouple Contacts

For sizes 16 and 12 are available thermocouple materials, in a lot of arrangements as showed in the dedicated pages for each connector series.

Materials we can supply for this application are:

- Chromel
- Alumel
- Iron
- Constantan
- Copper



CONNECTOR CONTACTS

IT - ITS - ITS-RG - ITZ Connectors



Contacts - Material, Plating and Type

A

PLATING

Silver plating is the standard finish for these connector series, thickness of $3\mu\text{m}$ as minimum on a suitable under-plating layer ($3\mu\text{m}^{+3/-0}$). We can provide as optional platings our standard Gold thick $0,4\mu\text{m}^{+0,2/-0}$, or our improved wearing resistance Heavy gold with a thickness of $0,8\mu\text{m}^{+0,2/-0}$.

Performances of our electroplated precious metal are tested by our internal qualified ISO/IEC 17025 Laboratory according ASTM B-700, MIL-DTL-45204 and SAE AS39029 specifications.

WIRE TERMINATION

Connectors of the series IT, ITS, ITS-RG and ITZ can be supplied both with crimp contacts to be assembled later into the insert, or with solder contacts already installed into the connector. Solder type contact is available in the PCB version also (PC TAIL).

Crimp technology requires a specific and dedicated crimping tool according material used, size, wire barrel design, etc. To guarantee a reliable termination for each contact, Glenair offers the right tool and accessories combination, from leading crimp tools manufacturers, according the tables in the "Crimping Tools" section of this catalog.

Since connectors for crimp contacts can be bought with or without contacts, therefore you can buy crimp contacts as spare parts also, according the full list in the "Part Numbering" section.

When you buy a contact as spare, not in bundle with the connector, pay attention to add the plating type at the end of p/n (see "How To Order" in the A-9 page).

Most of the standard crimp contacts offered for the series IT, ITS, IT-RG and ITZ have own special versions, with a modified wire barrel, in order to accommodate smaller and/or larger wire size than standard one.

The complete list of these contacts is again in the Part Numbers section.



Crimp (Wire) Barrel



Soldering Cup



Pc Tail

CONNECTOR CONTACTS

IT - ITS - ITS-RG - ITZ Connectors



How to Order (Only Crimp)

How to order			
Sample Part Number	10-113474-4P	-XX	YY
Basic Part Number	10-113474-4P		
Dash Version	Omitted for standard		
Plating	G10 = Silver G117 = Gold (0.4 μm) G112 = Heavy Gold (0.8 μm)		

A

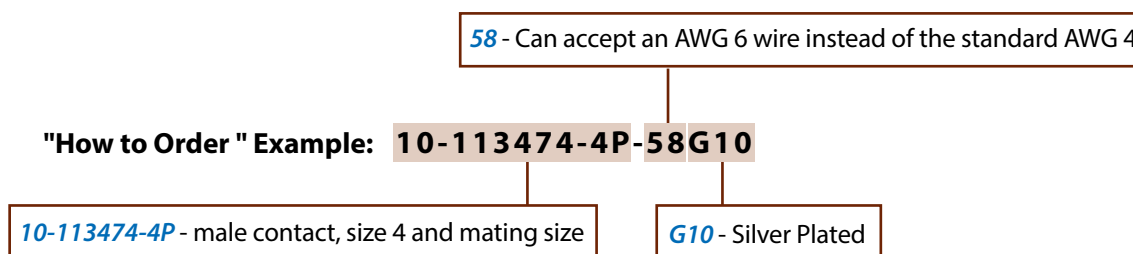

Important Notice: When you buy a connector of the IT, ITZ, ITS and ITS-RG series, their standard configuration include the std contact p/n (bold in the following tables), silver plated. Different needs have to be specified in the "How to order" configuration part number of the connector as follow:

- **G10** Silver plated contacts: (to be omitted)
- **G117** Gold plated contact: add B1 in the Modification Code
- **G112** Heavy Gold plated contact: add B12 in the Modification Code

For the special wire barrels (Dash Version) and other options please consult factory.

CONNECTOR CONTACTS

IT - ITS - ITS-RG - ITZ Connectors



Pin Crimp Contacts

A

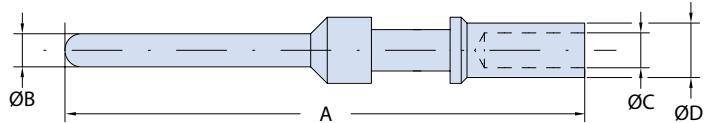

Pin Crimp Contact Part Numbers, Size & Dimensions Table 1/2

Part number	Contact Size	A		ØB		ØC		ØD		Wire Size	
		mm	Inches	mm	Inches	mm	Inches	mm	Inches	mm ²	AWG
10-375-20	20	24,30	0,957	1,00	0,039	1,30	0,051	1,93	0,076	0,15-0,6	26÷20
10-40579	18	29,60	1,165	1,40	0,055	1,30	0,051	1,93	0,076	0,15÷0,6	26÷20
10-40553	16S	26,60	1,047	1,58	0,062	1,70	0,067	2,60	0,102	1÷1,5	18÷16
10-40553-12	16S	26,60	1,047	1,58	0,062	1,19	0,047	2,59	0,102	0,6	20
10-40553-13*	16S	26,60	1,047	1,58	0,062	1,30	0,051	1,93	0,076	0,15÷0,6	26÷20
10-40553-15*	16S	26,60	1,047	1,58	0,062	1,50	0,059	2,60	0,102	0,75-1,0	18
10-40553-20	16S	26,60	1,047	1,58	0,062	2,00	0,079	2,90	0,114	1-2	14
10-40553-26	16S	26,60	1,047	1,58	0,062	2,5	0,098	3,8	0,150	2,5-3,0	12
10-40557	16	31,75	1,250	1,58	0,062	1,70	0,067	2,60	0,102	1÷1,5	18÷16
10-40557L	16	33,25	1,309	1,58	0,062	1,70	0,067	2,60	0,102	1÷1,5	18÷16
10-40557-08*	16	31,75	1,250	1,58	0,062	0,85	0,033	1,55	0,061	0,15÷0,2	26÷24
10-40557-12*	16	31,75	1,250	1,58	0,062	1,20	0,047	2,60	0,102	0,6	20
10-40557-13*	16	31,75	1,250	1,58	0,062	1,30	0,051	1,93	0,076	0,15÷0,6	26÷20
10-40557-15*	16	31,75	1,250	1,58	0,062	1,50	0,059	2,60	0,102	0,75-1,0	18
10-40557-20**	16	31,75	1,250	1,58	0,062	2,00	0,079	2,90	0,114	1-2	14
10-40557-22**	16	31,75	1,250	1,57	0,062	2,2	0,087	3,8	0,150	2,5	/
10-40557-22L**	16	33,25	1,309	1,57	0,062	2,2	0,087	3,8	0,150	2,5	/
10-40557-26**	16	31,75	1,250	1,58	0,062	2,5	0,098	3,8	0,150	2,5-3,0	12
10-40557-32*	16	31,75	1,250	1,58	0,062	0,45	0,018	1,95	0,077	/	32÷28
10-40561	12	37,65	1,482	2,38	0,094	2,50	0,098	3,90	0,154	2,5-3,0	12
10-40561-12*	12	37,65	1,482	2,38	0,094	1,20	0,047	2,60	0,102	0,6	20
10-40561-15*	12	37,65	1,482	2,38	0,094	1,50	0,059	2,60	0,102	0,75-1,0	18
10-40561-177*	12	37,65	1,482	2,38	0,094	1,77	0,070	2,75	0,108	1,5	18-16
10-40561-20*	12	37,65	1,482	2,38	0,094	2,00	0,079	3,90	0,154	2	14
10-40561-22*	12	37,65	1,482	2,38	0,094	2,10	0,083	3,90	0,154	2,5	/
10-40561-30**	12	37,65	1,482	2,38	0,094	3,00	0,118	4,80	0,189	4-5	/
10-40561-30M**	12	37,65	1,482	2,38	0,094	3,30	0,130	4,20	0,165	4	/
10-40561-38**	12	37,65	1,482	2,38	0,094	3,60	0,142	4,8	0,189	6	10

Please consult our sales department for other contacts or crimp tooling details.

PLATING OPTIONS

G10 : Silver (Standard)

G117 : Gold

G112: Heavy Gold

Note

*These contacts accept smaller wire than standard ones. There may be a sealing problem with grommets. The max current rating is limited by the wire max current rating.

** These contacts accept larger wires than standard ones. The reduced air/creepage distance may worsen the service rating and there may be difficulties with grommets. The max current rating is limited by the contact max current rating.

Please contact factory for solutions.

CONNECTOR CONTACTS

IT - ITS - ITS-RG - ITZ Connectors



Pin Crimp Contacts

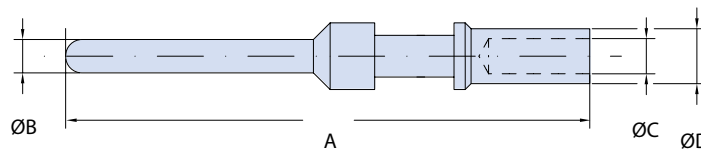

Pin Crimp Contact Part Numbers, Size & Dimensions Table 2/2

Part number	Contact Size	A		ØB		ØC		ØD		Wire Size	
		mm	Inches	mm	Inches	mm	Inches	mm	Inches	mm ²	AWG
10-40792	8	42,00	1,654	3,60	0,142	4,50	0,177	6,90	0,272	9	8
10-40792-15*	8	42,00	1,654	3,60	0,142	1,50	0,059	3,40	0,134	0,75-1,0	18
10-40792-18*	8	42,00	1,654	3,60	0,142	1,80	0,071	3,80	0,150	1÷2	18÷14
10-40792-20*	8	42,00	1,654	3,60	0,142	2,00	0,079	3,80	0,150	2	14
10-40792-26*	8	42,00	1,654	3,60	0,142	2,5	0,098	3,8	0,150	3	12-14
10-40792-30*	8	42,00	1,654	3,60	0,142	3,00	0,118	4,80	0,189	4-5	/
10-40792-38*	8	42,00	1,654	3,60	0,142	3,60	0,142	6,80	0,268	6	10
10-40792-50**	8	42,00	1,654	3,60	0,142	5,00	0,197	6,90	0,272	10	/
10-40792-58**	8	42,00	1,654	9,05	0,356	5,80	0,228	7,80	0,307	13,2	6
10-113474-4P	4	42,00	1,654	5,70	0,224	7,10	0,280	9,53	0,375	22-25	4
10-113474-4P-22*	4	42,00	1,654	5,70	0,224	2,20	0,087	3,80	0,150	2,5	/
10-113474-4P-25	Replaced by 10-113474-4P										
10-113474-4P-26*	4	42,00	1,654	5,70	0,224	2,50	0,098	3,80	0,150	3	/
10-113474-4P-30*	4	42,00	1,654	5,70	0,224	3,00	0,118	4,80	0,189	4-5	/
10-113474-4P-38*	4	42,00	1,654	5,70	0,224	3,60	0,142	6,80	0,268	6	10
10-113474-4P-50*	4	42,00	1,654	5,70	0,224	5,00	0,197	7,00	0,276	10	/
10-113474-4P-58*	4	42,00	1,654	9,05	0,356	5,80	0,228	7,80	0,307	13,2	6
10-113474-4P-62*	4	42,00	1,654	5,70	0,224	6,20	0,244	9,53	0,375	16	/
10-113474-1P	0	45,00	1,772	9,05	0,356	11,50	0,453	14,30	0,563	50-60	0
10-113474-1P-107*	0	45,00	1,772	9,05	0,356	10,70	0,421	14,35	0,565	50	/
10-113474-1P-78*	0	45,00	1,772	9,05	0,356	7,15	0,281	9,50	0,374	22-25	4
10-113474-1P-35*	0	45,00	1,772	9,05	0,356	9,00	0,354	14,35	0,565	35	/
10-113474-1P-45*	0	45,00	1,772	9,05	0,356	4,55	0,179	6,80	0,268	9	8
10-113474-1P-50*	0	45,00	1,772	9,05	0,356	5,00	0,197	7,00	0,276	10	/
10-113474-1P-58*	0	45,00	1,772	9,05	0,356	5,80	0,228	7,80	0,307	13,2	6
10-113474-1P-62*	0	45,00	1,772	9,05	0,356	6,20	0,244	9,50	0,374	16	/
10-113474-0P*	4/0	63,00	2,480	12,69	0,500	16,5	0,650	20	0,787	107	4/0
10-113474-0P-78*	4/0	63,00	2,480	12,69	0,500	7,10	0,280	9,53	0,375	22-25	4
10-113474-0P-107*	4/0	63,00	2,480	12,69	0,500	10,7	0,421	14,35	0,565	50	/
10-113474-0P-144*	4/0	63,00	2,480	12,69	0,500	14,5	0,571	20	0,787	70	/

Please consult our sales department for other contacts or crimp tooling details.

PLATING OPTIONS

G10 : Silver (Standard)

G117 : Gold

G112: Heavy Gold

Note

*These contacts accept smaller wire than standard ones. There may be a sealing problem with grommets. The max current rating is limited by the wire max current rating.

** These contacts accept larger wires than standard ones. The reduced air/creepage distance may worsen the service rating and there may be difficulties with grommets. The max current rating is limited by the contact max current rating.

Please contact factory for solutions.

CONNECTOR CONTACTS

IT - ITS - ITS-RG - ITZ Connectors



Socket Crimp Contacts

A

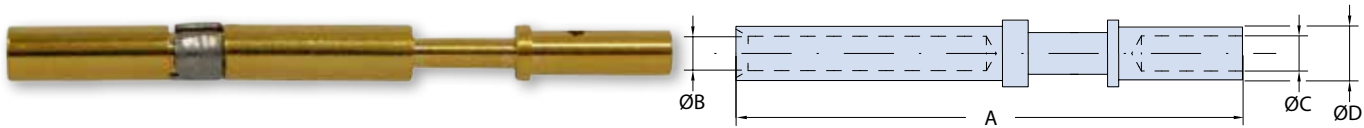

Socket Crimp Contact Part Numbers, Size & Dimensions Table 1/2

Part number	Contact Size	A		ØB		ØC		ØD		Wire Size	
		mm	Inches	mm	Inches	mm	Inches	mm	Inches	mm ²	AWG
10-40520LC	20	36,5	1,437	1,08	0,043	1,3	0,051	1,93	0,076	0,15-0,6	26-20
10-40588	18	34,4	1,354	1,46	0,057	1,3	0,051	1,93	0,076	0,15-0,6	26-20
10-40552	16S	26,6	1,047	1,65	0,065	1,7	0,067	2,60	0,102	1-1,5	18-16
10-40552 TU	16S	26,6	1,047	1,65	0,065	1,7	0,067	2,60	0,102	1-1,5	18-16
10-40552-12*	16S	26,6	1,047	1,65	0,065	1,2	0,047	2,60	0,102	0,6	20
10-40552-13*	16S	26,6	1,047	1,65	0,065	1,3	0,051	1,93	0,076	0,15-0,6	26-20
10-40552-15*	16S	26,6	1,047	1,65	0,065	1,5	0,059	2,60	0,102	0,75-1	18
10-40552-20**	16S	26,6	1,047	1,65	0,065	2,0	0,079	2,90	0,114	1-2	14
10-40552-26**	16S	26,6	1,047	1,65	0,065	2,5	0,098	3,80	0,150	2,5-3,0	12
10-40556	16	36,5	1,437	1,65	0,065	1,7	0,067	2,60	0,102	1-1,5	18-16
10-40556 TU	16	36,5	1,437	1,65	0,065	1,7	0,067	2,60	0,102	1-1,5	18-16
10-40556-08*	16	36,5	1,437	1,65	0,065	0,85	0,033	1,55	0,061	0,15-0,2	26-24
10-40556-12*	16	36,5	1,437	1,65	0,065	1,2	0,047	2,60	0,102	0,6	20
10-40556-13*	16	36,5	1,437	1,65	0,065	1,3	0,051	1,93	0,076	0,15-0,6	26-20
10-40556-15*	16	36,5	1,437	1,65	0,065	1,45	0,057	2,60	0,102	0,75-1	18
10-40556-20**	16	36,5	1,437	1,65	0,065	2,0	0,079	2,90	0,114	1-2	14
10-40556-22**	16	36,5	1,437	1,65	0,065	2,2	0,087	3,8	0,150	2,5	/
10-40556-26**	16	36,5	1,437	1,65	0,065	2,5	0,098	3,80	0,150	2,5-3,0	12
10-40556-32*	16	36,5	1,437	1,65	0,065	0,45	0,018	1,95	0,077	/	32-28
10-40560	12	37,65	1,482	2,48	0,098	2,5	0,098	3,9	0,154	2,5-3,0	12
10-40560 TU	12	37,65	1,482	2,48	0,098	2,5	0,098	3,9	0,154	2,5-3,0	12
10-40560-12*	12	37,65	1,482	2,48	0,098	1,2	0,047	2,6	0,102	0,6	20
10-40560-15*	12	37,65	1,482	2,48	0,098	1,45	0,057	2,60	0,102	0,75-1	18
10-40560-177*	12	37,65	1,482	2,48	0,098	1,77	0,070	2,75	0,108	1,5	18-16
10-40560-20*	12	37,65	1,482	2,48	0,098	2,0	0,079	3,8	0,150	2	14
10-40560-22*	12	37,65	1,482	2,48	0,098	2,1	0,083	3,8	0,150	2,5	/
10-40560-30**	12	37,65	1,482	2,38	0,094	3,00	0,118	4,80	0,189	4-5	/
10-40560-30M**	12	37,65	1,482	2,38	0,094	3,30	0,130	4,20	0,165	4	/
10-40560-38**	12	37,65	1,482	2,38	0,094	3,60	0,142	4,80	0,189	6	10

Please consult our sales department for other contacts or crimp tooling details.

PLATING OPTIONS

G10 : Silver (Standard)

G117 : Gold

G112: Heavy Gold

Note

*These contacts accept smaller wire than standard ones. There may be a sealing problem with grommets. The max current rating is limited by the wire max current rating.

** These contacts accept larger wires than standard ones. The reduced air/creepage distance may worsen the service rating and there may be difficulties with grommets. The max current rating is limited by the contact max current rating.

Please contact factory for solutions.

CONNECTOR CONTACTS

IT - ITS - ITS-RG - ITZ Connectors



Socket Crimp Contacts

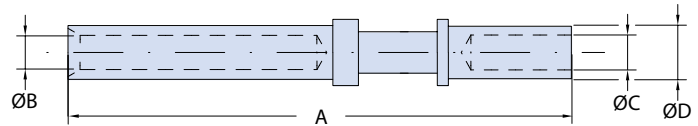

Socket Crimp Contact Part Numbers, Size & Dimensions Table 2/2

Part number	Contact Size	A		ØB		ØC		ØD		Wire Size	
		mm	Inches	mm	Inches	mm	Inches	mm	Inches	mm ²	AWG
10-40793-1	8	40,5	1,594	3,70	0,146	4,5	0,177	6,75	0,266	9	8
10-40793-1-15*	8	40,5	1,594	3,70	0,146	1,45	0,057	3,4	0,134	0,75-1	18
10-40793-1-18*	8	40,5	1,594	3,70	0,146	1,8	0,071	3,8	0,150	1-2	18-14
10-40793-1-20*	8	40,5	1,594	3,60	0,142	2,00	0,079	3,80	0,150	2	14
10-40793-1-26*	8	40,5	1,594	3,70	0,146	2,5	0,098	3,8	0,150	3	12
10-40793-1-30*	8	40,5	1,594	3,70	0,146	3,0	0,118	4,8	0,189	4-5	/
10-40793-1-38*	8	40,5	1,594	3,70	0,146	3,6	0,142	6,8	0,268	6	10
10-40793-1-50**	8	40,5	1,594	3,70	0,146	5,0	0,197	6,9	0,272	10	/
10-10793-1-58**	8	40,5	1,594	3,70	0,146	5,8	0,228	7,8	0,307	13,2	6
10-113474-4S-1	4	41,0	1,614	5,80	0,228	7,1	0,280	9,53	0,375	22-25	4
10-113474-4S-1-22*	4	41,0	1,614	5,80	0,228	2,2	0,087	3,8	0,150	2,5	/
10-113474-4S-1-25	Replaced by 10-113474-4S-1										
10-113474-4S-1-26*	4	41,0	1,614	5,80	0,228	2,5	0,098	3,8	0,150	3	/
10-113474-4S-1-30*	4	41,0	1,614	5,80	0,228	3,0	0,118	4,8	0,189	4-5	/
10-113474-4S-1-38*	4	41,0	1,614	5,80	0,228	3,6	0,142	6,8	0,268	6	10
10-113474-4S-1-50*	4	41,0	1,614	5,80	0,228	5,0	0,197	7,0	0,276	10	/
10-113474-4S-1-58*	4	41,0	1,614	5,80	0,228	5,8	0,228	7,8	0,307	13,2	6
10-113474-4S-62*	4	41,0	1,614	5,80	0,228	6,2	0,244	9,5	0,374	16	/
10-113474-1S	0	44,6	1,756	9,17	0,361	11,5	0,453	14,3	0,563	50-60	0
10-113474-1S-107*	0	44,6	1,756	9,17	0,361	10,7	0,421	14,35	0,565	50	/
10-113474-1S-78*	0	44,6	1,756	9,17	0,361	7,15	0,281	9,5	0,374	22-25	4
10-113474-1S-35*	0	44,6	1,756	9,17	0,361	9,0	0,354	14,35	0,565	35	/
10-113474-1S-45*	0	44,6	1,756	9,17	0,361	4,55	0,179	6,8	0,268	9	8
10-113474-1S-50*	0	44,6	1,756	9,17	0,361	5,0	0,197	7,0	0,276	10	/
10-113474-1S-58*	0	44,6	1,756	9,17	0,361	5,8	0,228	7,8	0,307	13,2	6
10-113474-1S-62*	0	45,3	1,783	9,17	0,361	6,2	0,244	9,5	0,374	16	/
10-113474-0S	4/0	65,9	2,594	12,7	0,500	16,5	0,650	20	0,787	107	4/0
10-113474-0S-78*	4/0	65,9	2,594	12,7	0,500	7,15	0,281	9,5	0,374	22-25	4
10-113474-0S-107*	4/0	65,9	2,594	12,7	0,500	10,7	0,421	14,35	0,565	50	/
10-113474-0S-144*	4/0	65,9	2,594	12,7	0,500	14,5	0,571	20	0,787	70	/

Please consult our sales department for other contacts or crimp tooling details.

PLATING OPTIONS

G10 : Silver (Standard)

G117 : Gold

G112: Heavy Gold

Note

*These contacts accept smaller wire than standard ones. There may be a sealing problem with grommets. The max current rating is limited by the wire max current rating.

** These contacts accept larger wires than standard ones. The reduced air/creepage distance may worsen the service rating and there may be difficulties with grommets. The max current rating is limited by the contact max current rating.

Please contact factory for solutions.

CONNECTOR CONTACTS

IT - ITS - ITS-RG - ITZ Connectors



Size 8 Coaxial Pin and Socket Contacts

A

COAXIAL PIN CONTACT

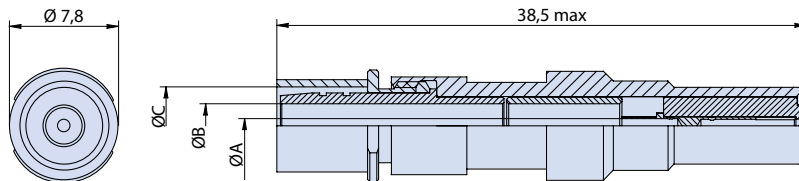

COAXIAL SOCKET CONTACT

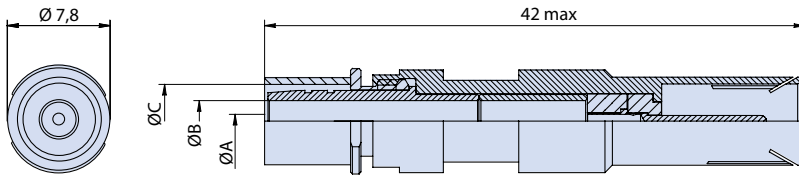

Coaxial Pin and Socket Contact Part Number, Cable information and Dimensions

Pin P/N	Socket P/N	Used with Cable	Ø A	Ø B	Ø C
CC 70038	CC 70040	RG 58	1.05	3.15	5.23
CC 70046	CC 70042	RG 59	0.75	3,90	5,60
CC 70054	CC 70052	RG 179	0.55	1,70	3,10
CC 70056	CC 70058	RG 174 / RG 316	0.75	1,70	3,10
CC 70060	CC 70062	RG 142	1.05	3.15	5,60
CC 70064	CC 70066	RG 223	1.05	3.15	5,90

COAXIAL INSERTION AND EXTRACTION TOOL - SIZE 8



M.118260/C

Insertion and Extraction Tool for COAX Contacts Size 8

CONNECTOR CONTACTS IT - ITS - ITS-RG - ITZ Connectors



Coaxial Contacts Assembly

A

COAXIAL CONTACTS ASSEMBLY

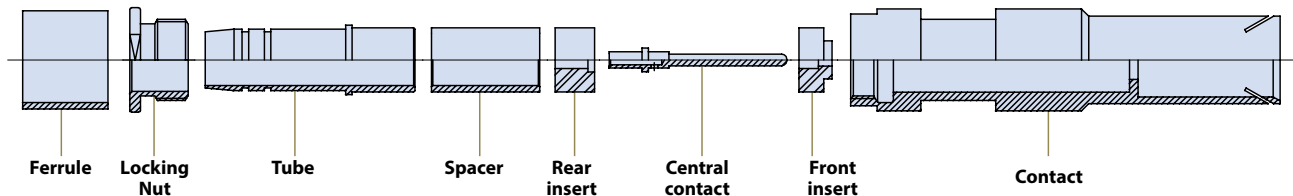

1 – Strip the cable according to the following dimensions

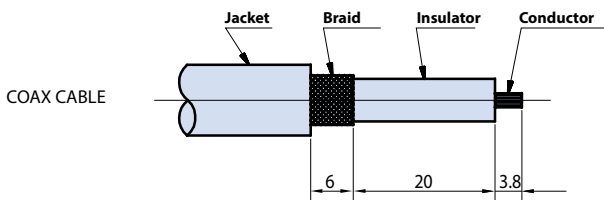

2 – Solder the central contact with the conductor of the coax cable after having pre-tinned the hole of the contact and the conductor, too

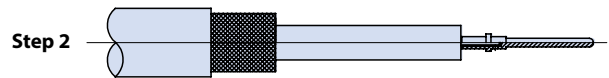

3 – Place the ferrule on the braid

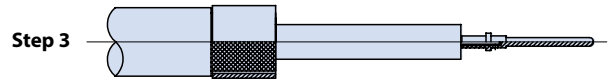

4 – Place the locking nut on the tube and then this one on the insulator, then insert the tube under the braid



5 – Crimp the ferrule on the braid using the follow tools:

- Crimping tool: M22520 / 5-01
- Die assy for RG58: M22520 / 5-05 A
- Die assy for RG59: M22520 / 5-45 B
- Die assy for RG142: M22520 / 5-45 B
- Die assy for RG174: M22520 / 5-08 A
- Die assy for RG179: M22520 / 5-08 A
- Die assy for RG223: M22520 / 5-45 A

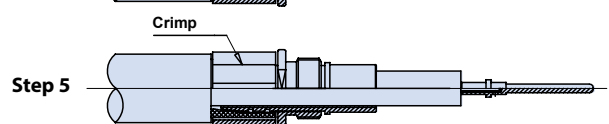

Note: the nut has to remain free to rotate

6 – Withdraw the spacer on the insulator till it stops against the tube

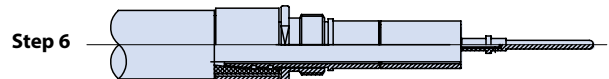

7 – Place the rear insert on the central contact by the cut on the side

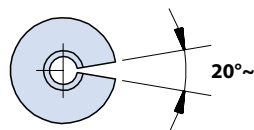

8 – Place the front insert on the central contact and insert everything inside the contact lightly pressing the rear insert; then screw the nut and the contact together.

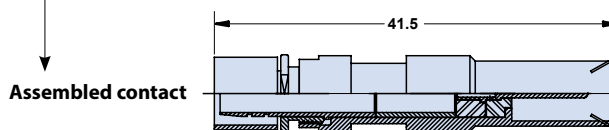
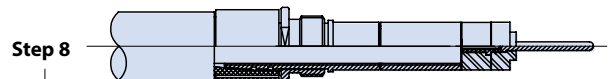

CONNECTOR CONTACTS

IT - ITS - ITS-RG - ITZ Connectors



Louver Band Socket Contacts

A

These contacts series are precision-machined using high conductivity copper alloy. A stamped and formed spring (“louverband”) is installed into the socket contact. The spring is made from 6 mil beryllium copper (BeCu). Testing has demonstrated that this contact system outperforms conventional aerospace-grade contact systems. The louverband spring provides many points of electrical contact with the mating pin, as opposed to a few “high spots” on a conventional four-finger contact as shown in Fig. 2. The louverband design offers lower voltage drop for reduced temperature rise and higher current carrying capacity. In addition to its electrical advantages, the louverband also is mechanically superior to four-finger contacts. The louverband spring has consistent, stable normal force, even when subjected to thousands of mating cycles and temperature extremes.



Figure 1. LouverBand Socket Contact

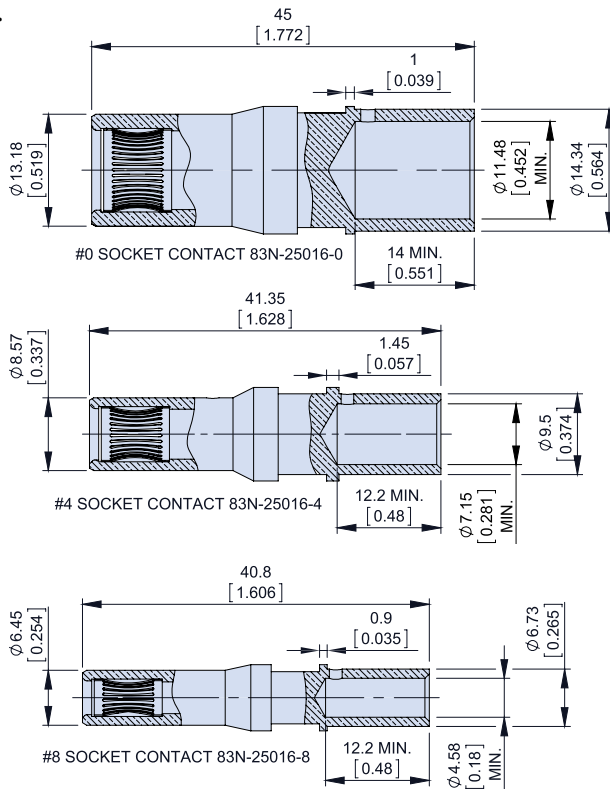

Figure 2. Conventional Contact on the left, LouverBand Contact on the right



Size	Wire Size	Part Number
0	#0	83N-25016-0G10-L
4	#4	83N-25016-4G10-L
8	#8	83N-25016-8G10-L

Contact Size	Current Rating		Contact Resistance (mΩ Max.)	Min Separation Force (ounces) min Diameter SAE-AS31971 pin	Max Average Engagement Force (ounces) Max Diameter SAE-AS31971 pin
	Rated current at +20°C (Ampere)	Rated current at +80°C (Ampere)			
0	300	250	0.2	15	320
4	160	130	0.5	10	240
8	90	70	1	5	160

CONNECTOR CONTACTS

IT - ITS - ITS-RG - ITZ Connectors



Reducers

For crimp contacts are available special reducers in order to accommodate a smaller wire size in a contact. The reducer is fully inserted into the wire barrel, then the crimping of the wire can be performed.

A



AWG4 to AWG8 reducer



**Size 4 contact
with AWG4 wire barrel**



**Size 4 contact
with AWG8 reducer**

Part Number	Contact Size	From wire size	To wire size
10-869-20A-26AG117	20	AWG 20	AWG 26
10-869-16A-22AG10	16	AWG 16	AWG 22
10-869-16A-20AG10	16	AWG 16	AWG 20
10-869-12A-26AG10	12	AWG 12	AWG 26
10-869-12A-20AG10	12	AWG 12	AWG 20
10-869-12A-16AG10	12	AWG 12	AWG 16
10-869-8A-18AG10	8	AWG 8	AWG 18
10-869-8A-16AG10	8	AWG 8	AWG 16
10-869-8A-14AG10	8	AWG 8	AWG 14
10-869-8A-12AG10	8	AWG 8	AWG 12
10-869-8A-10AG10	8	AWG 8	AWG 10
10-869-8A-2.5MG10	8	AWG 8	2,5 mm2
10-869-8A-6MG10	8	AWG 8	6 mm2
10-869-4A-8AG10	4	AWG 4	AWG 8
10-869-4A-6AG10	4	AWG 4	AWG 6
10-869-4A-16MG10	4	AWG 4	16 mm2
10-869-4A-10MG10	4	AWG 4	10 mm2
10-869-4A-6MG10	4	AWG 4	6 mm2
10-869-4A-2.5MG10	4	AWG 4	2,5 mm2
10-869-0A-6AG10	0	AWG 0	AWG 6
10-869-0A-2AG10	0	AWG 0	AWG 2
10-869-0A-50MG10	0	AWG 0	50 mm2
10-869-0A-35MG10	0	AWG 0	35 mm2
10-869-0A-25MG10	0	AWG 0	25 mm2
10-869-0A-16MG10	0	AWG 0	16 mm2
10-869-0A-10MG10	0	AWG 0	10 mm2
10-869-4/0A-70MG10	4/0	AWG 4/0	70 mm2

Please consult our Sales Department for other options.

CONNECTOR CONTACTS IT - ITS - ITS-RG - ITZ Connectors



Pin Crimp Contacts - Insertion and Removal Tools

A

Insertion and Removal Tools Table					
Part Number	Contact Size	Wire Size		Insertion Tool	Removal Tool
		mm ²	AWG	Glenair P/N	Glenair P/N
10-375-20	20	0,15-0,6	26÷20	M.117346	M.118251
10-40579	18	0,15÷0,6	26÷20	M.117346	M.118249
10-40553	16S	1÷1,5	18÷16	M.117083	M.118250
10-40553-12	16S	0,6	20	M.117083	M.118250
10-40553-13	16S	0,15÷0,6	26÷20	M.117346	M.118250
10-40553-15	16S	0,75-1,0	18	M.117083	M.118250
10-40553-20	16S	1-2	14	M.117083	M.118250
10-40553-26	16S	2,5-3,0	12	M.117082	M.118250
10-40557	16	1÷1,5	18÷16	M.117083	M.118250
10-40557L	16	1÷1,5	18÷16	M.117083	M.118250
10-40557-08	16	0,15÷0,2	26÷24	M.117346	M.118250
10-40557-12	16	0,6	20	M.117083	M.118250
10-40557-13	16	0,15÷0,6	26÷20	M.117346	M.118250
10-40557-15	16	0,75-1,0	18	M.117083	M.118250
10-40557-20	16	1-2	14	M.117083	M.118250
10-40557-22	16	2,5	/	M.117083	M.118250
10-40557-22L	16	2,5	/	M.117083	M.118250
10-40557-26	16	2,5-3,0	12	M.117083	M.118250
10-40557-32	16	/	32÷28	M.117083	M.118250
10-40561	12	2,5-3,0	12	M.117082	M.118250
10-40561-12	12	0,6	20	M.117083	M.118250
10-40561-15	12	0,75-1,0	18	M.117083	M.118250
10-40561-177	12	1,5	18-16	M.117082	M.118250
10-40561-20	12	2	14	M.117082	M.118250
10-40561-22	12	2,5	/	M.117082	M.118250
10-40561-30	12	4-5	/	M.117082	M.118250
10-40561-30M	12	4	/	M.117082	M.118250
10-40561-38	12	6	10	M.117082	M.118250

Please consult our sales department for other contact options or crimp tooling details.



CONNECTOR CONTACTS IT - ITS - ITS-RG - ITZ Connectors



Pin Crimp Contacts - Insertion and Removal Tools

A

Insertion and Removal Tools Table					
Part Number	Contact Size	Wire Size		Insertion Tool	Removal Tool
		mm ²	AWG	Glenair P/N	Glenair P/N
10-40792	8	9	8	M.117344	M.118260
10-40792-15	8	0,75-1,0	18	M.117082	M.118260
10-40792-18	8	1÷2	18÷14	M.117082	M.118260
10-40792-20	8	2	14	M.117082	M.118260
10-40792-26	8	3	12 -14	M.117082	M.118260
10-40792-30	8	4-5	/	M.117082	M.118260
10-40792-38	8	6	10	M.117344	M.118260
10-40792-50	8	10	/	M.117344	M.118260
10-40792-58	8	13,2	6	M.117344	M.118260
10-113474-4P	4	25	4	M.117347	M.118270
10-113474-4P-22	4	2,5	/	M.117082	M.118270
10-113474-4P-26	4	3	/	M.117082	M.118270
10-113474-4P-30	4	4-5	/	M.117082	M.118270
10-113474-4P-38	4	6	10	M.117344	M.118270
10-113474-4P-50	4	10	/	M.117344	M.118270
10-113474-4P-58	4	13,2	6	M.117344	M.118270
10-113474-4P-62	4	16	/	M.117347	M.118270
10-113474-1P	0	50-60	0	M.117348	M.118280
10-113474-1P-107	0	50	/	M.117348	M.118280
10-113474-1P-72	0	22-25	4	M.117347	M.118280
10-113474-1P-35	0	35	/	M.117348	M.118280
10-113474-1P-45	0	9	8	M.117344	M.118280
10-113474-1P-50	0	10	/	M.117344	M.118280
10-113474-1P-58	0	13,2	6	M.117344	M.118280
10-113474-1P-62	0	16	/	M.117347	M.118280
10-113474-0P	4/0	107	4/0	/	/
10-113474-0P-78	4/0	25	/	/	/
10-113474-0P-107	4/0	50	/	/	/
10-113474-0P-144	4/0	70	/	/	/

Please consult our sales department for other contact options or crimp tooling details.



CONNECTOR CONTACTS IT - ITS - ITS-RG - ITZ Connectors



Socket Crimp Contacts - Insertion and Removal Tools

A

Insertion and Removal Tools Table						
Part Number	Contact Size	Wire Size		Insertion Tool	Removal Tool	Guide Pin
		mm ²	AWG	Glenair P/N	Glenair P/N	
10-40520LC	20	0,15-0,6	26-20	M.117346	M.118251	M.125007
10-40588	18	0,15-0,6	26-20	M.117346	M.118249	M.125000
10-40552	16S	1-1,5	18-16	M.117083	M.118250	M.125001
10-40552-12	16S	0,6	20	M.117083	M.118250	M.125001
10-40552-13	16S	0,15-0,6	26-20	M.117346	M.118250	M.125001
10-40552-15	16S	0,75-1	18	M.117083	M.118250	M.125001
10-40552-20	16S	1-2	14	M.117083	M.118250	M.125001
10-40552-26	16S	2,5-3,0	12	M.117082	M.118250	M.125001
10-40556	16	1-1,5	18-16	M.117083	M.118250	M.125001
10-40556-08	16	0,15-0,2	26-24	M.117346	M.118250	M.125001
10-40556-12	16	0,6	20	M.117083	M.118250	M.125001
10-40556-13	16	0,15-0,6	26-20	M.117346	M.118250	M.125001
10-40556-15	16	0,75-1	18	M.117083	M.118250	M.125001
10-40556-20	16	1-2	14	M.117083	M.118250	M.125001
10-40556-22	16	2,5	/	M.117083	M.118250	M.125001
10-40556-26	16	2,5-3,0	12	M.117082	M.118250	M.125001
10-40556-32	16	/	32-28	M.117083	M.118250	M.125001
10-40560	12	2,5-3,0	12	M.117082	M.118250	M.125002
10-40560-12	12	0,6	20	M.117083	M.118250	M.125002
10-40560-15	12	0,75-1	18	M.117083	M.118250	M.125002
10-40560-177	12	1,5	18-16	M.117082	M.118250	M.125002
10-40560-20	12	2	14	M.117082	M.118250	M.125002
10-40560-22	12	2,5	/	M.117082	M.118250	M.125002
10-40560-30	12	4-5	/	M.117082	M.118250	M.125002
10-40560-30M	12	4	/	M.117082	M.118250	M.125002
10-40560-38	12	6	10	M.117082	M.118250	M.125002

Please consult our sales department for other contact options or crimp tooling details.



CONNECTOR CONTACTS IT - ITS - ITS-RG - ITZ Connectors



Socket Crimp Contacts - Insertion and Removal Tools

A

Insertion and Removal Tools Table						
Part Number	Contact Size	Wire Size		Insertion Tool	Removal Tool	Guide Pin
		mm ²	AWG	Glenair P/N	Glenair P/N	
10-40793-1	8	9	8	M.117344	M.118260	M.125003
10-40793-1-15	8	0,75-1	18	M.117082	M.118260	M.125003
10-40793-1-18	8	1-2	18-14	M.117082	M.118260	M.125003
10-40793-1-20	8	2	14	M.117082	M.118260	M.125003
10-40793-1-26	8	3	12	M.117082	M.118260	M.125003
10-40793-1-30	8	4-5	/	M.117082	M.118260	M.125003
10-40793-1-38	8	6	10	M.117344	M.118260	M.125003
10-40793-1-50	8	10	/	M.117344	M.118260	M.125003
10-10793-1-58	8	13,2	6	M.117344	M.118260	/
10-113474-4S-1	4	22-25	4	M.117347	M.118270	/
10-113474-4S-1-22	4	2,5	/	M.117082	M.118270	/
10-113474-4S-1-26	4	3	/	M.117082	M.118270	/
10-113474-4S-1-30	4	4-5	/	M.117082	M.118270	/
10-113474-4S-1-38	4	6	10	M.117344	M.118270	/
10-113474-4S-1-50	4	10	/	M.117344	M.118270	/
10-113474-4S-1-58	4	13,2	6	M.117344	M.118270	/
10-113474-4S-62	4	16	/	M.117347	M.118270	/
10-113474-1S	0	50-60	0	M.117348	M.118280	/
10-113474-1S-107	0	50	/	M.117348	M.118280	/
10-113474-1S-72	0	22-25	4	M.117347	M.118280	/
10-113474-1S-35	0	35	/	M.117348	M.118280	/
10-113474-1S-45	0	9	8	M.117344	M.118280	/
10-113474-1S-50	0	10	/	M.117344	M.118280	/
10-113474-1S-58	0	13,2	6	M.117344	M.118280	/
10-113474-1S-62	0	16	/	M.117347	M.118280	/
10-113474-0S	4/0	107	4/0	/	/	/
10-113474-0S-78	4/0	22-25	4	/	/	/
10-113474-0S-107	4/0	50	/	/	/	/
10-113474-0S-144	4/0	70	/	/	/	/

Please consult our sales department for other contact options or crimp tooling details.



CONNECTOR CONTACTS IT - ITS - ITS-RG - ITZ Connectors



Pin Crimp Contacts - Manual and Pneumatic Tools

A

Manual and Pneumatic Tools Table							
Part Number	Contact Size	Wire Size		Manual Crimp Tool		Pneumatic Tool Type "A"	
		mm ²	AWG	Manual Tool	Turret	Pneumatic Tool	Turret
10-375-20	20	0,15-0,6	26÷20	M.105001	M.105026	M.105003	M.105026
10-40579	18	0,15÷0,6	26÷20	M.105001	M.105025	M.105003	M.105025
10-40553	16S	1÷1,5	18÷16	M.105007	M.105009	M.105002	M.105009
10-40553-12	16S	0,6	20	M.105007	M.105009	M.105002	M.105009
10-40553-13	16S	0,15÷0,6	26÷20	M.105001	M.105009	M.105003	M.105009
10-40553-15	16S	0,75-1,0	18	M.105007	M.105009	M.105002	M.105009
10-40553-20	16S	1-2	14	M.105007	M.105009	M.105002	M.105009
10-40553-26	16S	2,5-3,0	12	M.105007	M.105009	M.105002	M.105009
10-40557	16	1÷1,5	18÷16	M.105007	M.105009	M.105002	M.105012
10-40557L	16	1÷1,5	18÷16	M.105007	M.105012	M.105002	M.105009
10-40557-08	16	0,15÷0,2	26÷24	M.105001	M.105009	M.105003	M.105009
10-40557-12	16	0,6	20	M.105007	M.105009	M.105003	M.105009
10-40557-13	16	0,15÷0,6	26÷20	M.105001	M.105009	M.105003	M.105009
10-40557-15	16	0,75-1,0	18	M.105007	M.105009	M.105002	M.105009
10-40557-20	16	1-2	14	M.105007	M.105009	M.105002	M.105009
10-40557-22	16	2,5	/	M.105007	M.105009	M.105002	M.105009
10-40557-22L	16	2,5	/	M.105007	M.105012	M.105002	M.105012
10-40557-26	16	2,5-3,0	12	M.105007	M.105009	M.105002	M.105009
10-40557-32	16	/	32÷28	M.105007	M.105009	M.105003	M.105009
10-40561	12	2,5-3,0	12	M.105007	M.105009	M.105002	M.105009
10-40561-12	12	0,6	20	M.105007	M.105009	M.105003	M.105009
10-40561-15	12	0,75-1,0	18	M.105007	M.105009	M.105002	M.105009
10-40561-177	12	1,5	18-16	M.105007	M.105009	M.105002	M.105009
10-40561-20	12	2	14	M.105007	M.105009	M.105002	M.105009
10-40561-22	12	2,5	/	M.105007	M.105009	M.105002	M.105009
10-40561-30	12	4-5	/	M.105007	M.105009	M.105002	M.105009
10-40561-30M	12	4	/	M.105007	M.105009	M.105002	M.105009
10-40561-38	12	6	10	M.105007	M.105009	M.105002	M.105009

Please consult our sales department for other contact options or crimp tooling details.

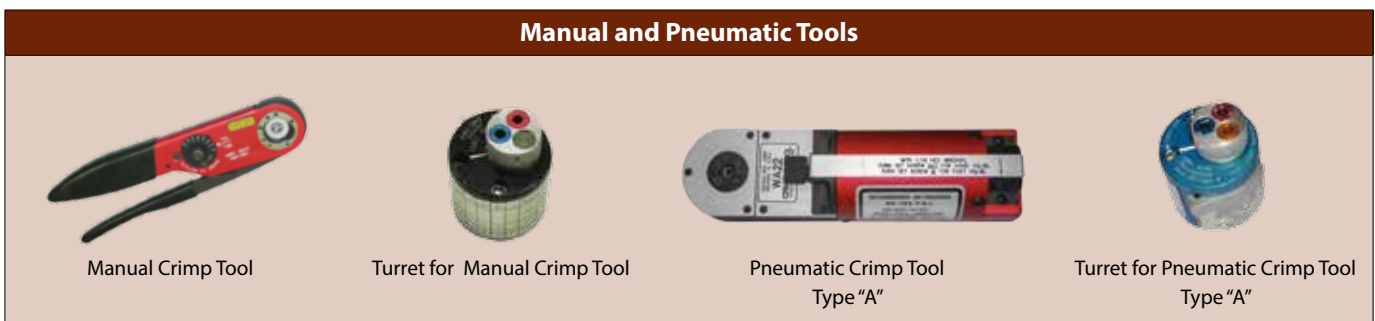

CONNECTOR CONTACTS IT - ITS - ITS-RG - ITZ Connectors



Pin Crimp Contacts - Manual and Pneumatic Tools

A

Manual and Pneumatic Tools Table										
Part Number	Contact Size	Wire Size		Manual Crimp Tool		Pneumatic Tool Type "B"			Oleodinamic Tool	
		mm ²	AWG	Manual Tool	Turret	Pneumatic Tool	Die	Locator	Oleodinamic Tool	Die
10-40792	8	9	8	/	/	M.112000	M.112001	M.112309	M.112004	M.112005
10-40792-15	8	0,75-1,0	18	M.105028	M.104002	/	/	/	/	/
10-40792-18	8	1÷2	18÷14	M.105028	M.104002	/	/	/	/	/
10-40792-20	8	2	14	M.105028	M.104002	/	/	/	/	/
10-40792-26	8	3	12 -14	M.105028	M.104002	/	/	/	/	/
10-40792-30	8	4-5	/	M.105028	M.104002	/	/	/	M.112004	M.112008
10-40792-38	8	6	10	/	/	M.112000	M.112001	M.112309	M.112004	M.112005
10-40792-50	8	10	/	/	/	M.112000	M.112001	M.112309	M.112004	M.112005
10-40792-58	8	13,2	6	/	/	M.112000	M.112001	M.112309	M.112004	M.112005
10-113474-4P	4	25	4	/	/	M.112000	M.112002	M.112311	M.112004	M.112006
10-113474-4P-22	4	2,5	/	/	/	/	/	/	M.112004	M.112009
10-113474-4P-26	4	3	/	/	/	/	/	/	M.112004	M.112009
10-113474-4P-30	4	4-5	/	/	/	/	/	/	M.112004	M.112008
10-113474-4P-38	4	6	10	/	/	M.112000	M.112001	M.112311	M.112004	M.112005
10-113474-4P-50	4	10	/	/	/	M.112000	M.112001	M.112311	M.112004	M.112005
10-113474-4P-58	4	13,2	6	/	/	M.112000	M.112001	M.112311	M.112004	M.112005
10-113474-4P-62	4	16	/	/	/	M.112000	M.112002	M.112311	M.112004	M.112006
10-113474-1P	0	50-60	0	/	/	M.112000	M.112003	M.112313	M.112004	M.112010
10-113474-1P-107	0	50	/	/	/	M.112000	M.112003	M.112313	M.112004	M.112010
10-113474-1P-72	0	22-25	4	/	/				M.112004	M.112006
10-113474-1P-35	0	35	/	/	/	/	/	/	M.112004	M.112007
10-113474-1P-45	0	9	8	/	/				M.112004	M.112005
10-113474-1P-50	0	10	/	/	/				M.112004	M.112005
10-113474-1P-58	0	13,2	6	/	/				M.112004	M.112005
10-113474-1P-62	0	16	/	/	/				M.112004	M.112006
10-113474-0P	4/0	107	4/0	/	/	/	/	/	M.105013	M.112012
10-113474-0P-78	4/0	25	/	/	/	/	/	/	M.112004	M.112006
10-113474-0P-107	4/0	50	/	/	/	/	/	/	M.112004	M.112010
10-113474-0P-144	4/0	70	/	/	/	/	/	/	M.105013	M.105053

Please consult our sales department for other contact options or crimp tooling details.

Manual and Pneumatic Tools				
				
Pneumatic Crimp Tool Type "B"	Die For Pneumatic Crimp Tool Type "B"	Locator for Pneumatic Crimp Tool Type "B"	Oleodinamic Crimp Tool	Die for Oleodinamic Crimp Tool

CONNECTOR CONTACTS IT - ITS - ITS-RG - ITZ Connectors



Socket Crimp Contacts - Manual and Pneumatic Tools

A

Manual and Pneumatic Tools Table							
Part Number	Contact Size	Wire Size		Manual Crimp Tool		Pneumatic Tool Type "A"	
		mm ²	AWG	Manual Tool	Turret	Pneumatic Tool	Turret
10-40520LC	20	0,15-0,6	26-20	M.105001	M.105026	M.105003	M.105026
10-40588	18	0,15-0,6	26-20	M.105001	M.105025	M.105003	M.105025
10-40552	16S	1-1,5	18-16	M.105007	M.105009	M.105002	M.105009
10-40552-12	16S	0,6	20	M.105007	M.105009	M.105002	M.105009
10-40552-13	16S	0,15-0,6	26-20	M.105001	M.105009	M.105003	M.105009
10-40552-15	16S	0,75-1	18	M.105007	M.105009	M.105002	M.105009
10-40552-20	16S	1-2	14	M.105007	M.105009	M.105002	M.105009
10-40552-26	16S	2,5-3,0	12	M.105007	M.105009	M.105002	M.105009
10-40556	16	1-1,5	18-16	M.105007	M.105009	M.105002	M.105009
10-40556-08	16	0,15-0,2	26-24	M.105001	M.105009	M.105003	M.105009
10-40556-12	16	0,6	20	M.105007	M.105009	M.105003	M.105009
10-40556-13	16	0,15-0,6	26-20	M.105001	M.105009	M.105003	M.105009
10-40556-15	16	0,75-1	18	M.105007	M.105009	M.105002	M.105009
10-40556-20	16	1-2	14	M.105007	M.105009	M.105002	M.105009
10-40556-22	16	2,5	/	M.105007	M.105009	M.105002	M.105009
10-40556-26	16	2,5-3,0	12	M.105007	M.105009	M.105002	M.105009
10-40556-32	16	/	32-28	M.105007	M.105009	M.105003	M.105009
10-40560	12	2,5-3,0	12	M.105007	M.105009	M.105002	M.105009
10-40560-12	12	0,6	20	M.105007	M.105009	M.105003	M.105009
10-40560-15	12	0,75-1	18	M.105007	M.105009	M.105002	M.105009
10-40560-177	12	1,5	18-16	M.105007	M.105009	M.105002	M.105009
10-40560-20	12	2	14	M.105007	M.105009	M.105002	M.105009
10-40560-22	12	2,5	/	M.105007	M.105009	M.105002	M.105009
10-40560-30	12	4-5	/	M.105007	M.105009	M.105002	M.105009
10-40560-30M	12	4	/	M.105007	M.105009	M.105002	M.105009
10-40560-38	12	6	10	M.105007	M.105009	M.105002	M.105009

Please consult our sales department for other contact options or crimp tooling details.

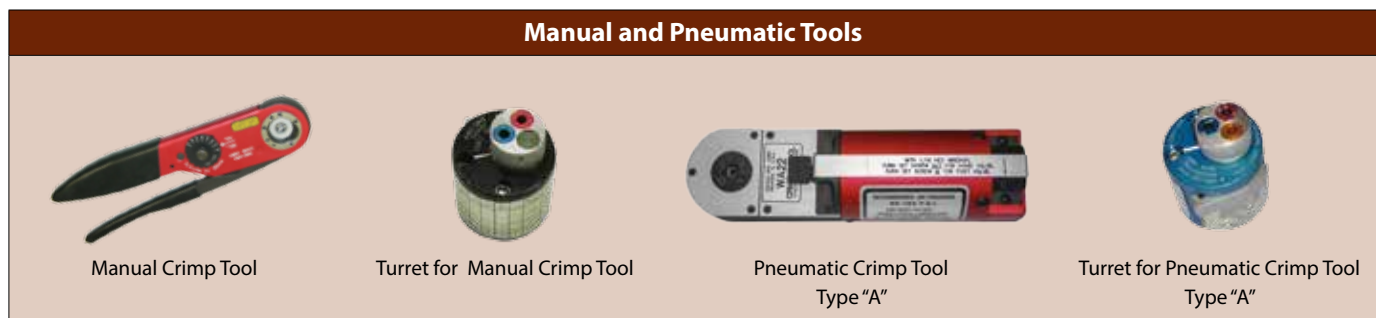

CONNECTOR CONTACTS IT - ITS - ITS-RG - ITZ Connectors



Socket Crimp Contacts - Manual and Pneumatic Tools

A

Manual and Pneumatic Tools Table										
Part Number	Contact Size	Wire Size		Manual Crimp Tool		Pneumatic Tool Type "B"			Oleodynamic Tool	
		mm ²	AWG	Manual Tool	Turret	Pneumatic Tool	Die	Locator	Oleodynamic Tool	Die
10-40793-1	8	9	8	/	/	M.112000	M.112001	M.112309	M.112004	M.112005
10-40793-1-15	8	0,75-1	18	M.105028	M.104002	/	/	/	/	/
10-40793-1-18	8	1-2	18-14	M.105028	M.104002	/	/	/	/	/
10-40793-1-20	8	2	14	M.105028	M.104002	/	/	/	/	/
10-40793-1-26	8	3	12	M.105028	M.104002	/	/	/	/	/
10-40793-1-30	8	4-5	/	M.105028	M.104002	/	/	/	M.112004	M.112008
10-40793-1-38	8	6	10	/	/	M.112000	M.112001	M.112309	M.112004	M.112005
10-40793-1-50	8	10	/	/	/	M.112000	M.112001	M.112309	M.112004	M.112005
10-10793-1-58	8	13,2	6	/	/	M.112000	M.112001	M.112309	M.112004	M.112005
10-113474-4S-1	4	25	4	/	/	M.112000	M.112002	M.112311	M.112004	M.112006
10-113474-4S-1-22	4	2,5	/	/	/	/	/	/	M.112004	M.112009
10-113474-4S-1-26	4	3	/	/	/	/	/	/	M.112004	M.112009
10-113474-4S-1-30	4	4-5	/	/	/	/	/	/	M.112004	M.112008
10-113474-4S-1-38	4	6	10	/	/	M.112000	M.112001	M.112311	M.112004	M.112005
10-113474-4S-1-50	4	10	/	/	/	M.112000	M.112001	M.112311	M.112004	M.112005
10-113474-4S-1-58	4	13,2	6	/	/	M.112000	M.112001	M.112311	M.112004	M.112005
10-113474-4S-62	4	16	/	/	/	M.112000	M.112002	M.112311	M.112004	M.112006
10-113474-1S	0	50-60	0	/	/	M.112000	M.112003	M.112313	M.112004	M.112010
10-113474-1S-107	0	50	/	/	/	M.112000	M.112003	M.112313	M.112004	M.112010
10-113474-1S-72	0	22-25	4	/	/	M.112000	M.112002	M.112313	M.112004	M.112006
10-113474-1S-35	0	35	/	/	/	/	/	/	M.112004	M.112007
10-113474-1S-45	0	9	8	/	/				M.112004	M.112005
10-113474-1S-50	0	10	/	/	/				M.112004	M.112005
10-113474-1S-58	0	13,2	6	/	/				M.112004	M.112005
10-113474-1S-62	0	16	/	/	/				M.112004	M.112006
10-113474-0S	4/0	107	4/0	/	/	/	/	/	M.105013	M.112012
10-113474-0S-78	4/0	25	/	/	/	/	/	/	M.112004	M.112006
10-113474-0S-107	4/0	50	/	/	/	/	/	/	M.112004	M.112010
10-113474-0S-144	4/0	70	/	/	/	/	/	/	M.105013	M.105053

Please consult our sales department for other contact options or crimp tooling details.

Manual and Pneumatic Tools				
				
Pneumatic Crimp Tool Type "B"	Die For Pneumatic Crimp Tool Type "B"	Locator for Pneumatic Crimp Tool Type "B"	Oleodynamic Crimp Tool	Die for Oleodynamic Crimp Tool

CONNECTOR CONTACTS IT - ITS - ITS-RG - ITZ Connectors



DMC Tools

A

Daniels (DMC) tools have been utilized in military aircraft and aerospace programs for over 60 years. Surely the leading company in crimping technology, it's used by Glenair as first choice for these powerful tools. Hereafter you find a cross table of P/Ns for our ruggedized power and signal connectors series ITS and the other MIL-DTL-5015 type products.



Manual Crimp Tool
AF8



Turret



Adjustable Positioner



Pneumatic Crimp Tool
WA23



Die Assy

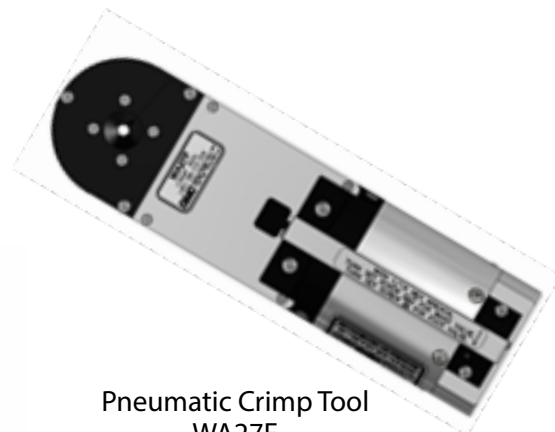

Pneumatic Crimp Tool
WA27F

Tool Description	DMC P/N	Glenair P/N
Manual crimp tool	AF8	M.105001
Manual crimp tool	VM8	M.105007
Manual crimp tool	M300BT	M.105028
Turret	VH435	M.105009
Adjustable Positioner	UH2-5	M.105012
Pneumatic crimp tool	WA27VM8	M.105002
Pneumatic crimp tool	WA27F	M.105003
Pneumatic crimp tool	WA23	M.112000
DIE ASSY 8	WA23-2	M.112001
DIE ASSY 4	WA23-4	M.112002
DIE ASSY 1/0	WA23-5	M.112003

Please consult our Sales Department for other options.

X-ON Electronics

Largest Supplier of Electrical and Electronic Components

Click to view similar products for [Circular MIL Spec Connector](#) category:

Click to view products by [Glenair](#) manufacturer:

Other Similar products are found below :

[0025-262-542](#) [0025-264-3014](#) [58-570121-04S](#) [0134-202-1200](#) [0134-207-1206](#) [0134-207-1800](#) [0134-207-2207](#) [0134-213-0806](#) [0134-213-1007](#) [0134-213-1009](#) [0134-213-1208](#) [0134-213-1800](#) [0134-213-2209](#) [0025-258-000](#) [015-9516-002](#) [60-042217-10P](#) [60-042722-19P](#) [0114-201-1278](#) [602GB06EG24-61SN](#) [0134-201-1207](#) [0134-201-1806](#) [0134-201-2006](#) [0134-201-2007](#) [0134-201-2010](#) [0134-202-1400](#) [0134-207-0809](#) [0134-207-1208](#) [0134-207-2009](#) [0134-213-1006](#) [6104-207-2302](#) [6104-208-1902](#) [6131-202-19149P](#) [6131-204-21149P](#) [6131-207-13149P](#) [6131-208-13149P](#) [6131-209-17149P](#) [6131-210-11149P](#) [6131-211-19149P](#) [6131-216-19149P](#) [6131-220-25149P](#) [6131-259-11149P](#) [6131-259-21149P](#) [6131-259-23149P](#) [6131-263-19149P](#) [6131-265-17149P](#) [6131-265-19149P](#) [6134-203-21149](#) [CS3102A-20-15P](#) [CS3102A-20-15S](#) [CS3102A-28-15S](#)