

SERIES 151 MIL-DTL-55116 QPL Field-Serviceable Audio Plug with wire strain relief



151-001 • M55116/3 - /4 • U-229



Series 151 MIL-DTL-55116 QPL audio plugs are designed for high-reliability, severe environment radio communications equipment. They are available in both 5 pin and 6 pin configurations, with either crimp sleeve (COTS) or solder cup terminals (QPL). All feature versatile wire strain relief to protect cable conductors from damage. Shells are made of nylon overmolded passivated stainless steel, contacts are gold plated copper alloy. Plug connector contacts are sealed in the unmated condition.

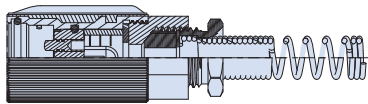

**U-229 Plug,
5 Crimp Contacts**

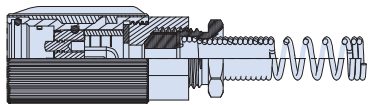
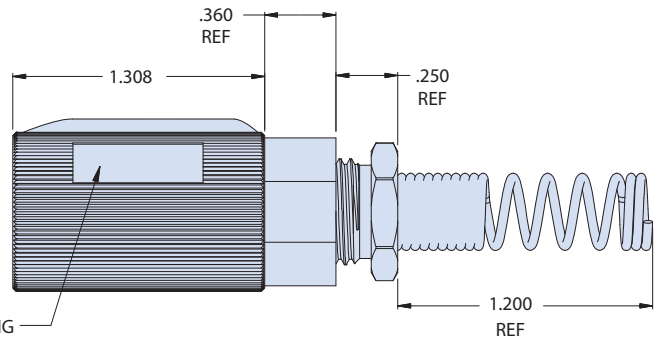
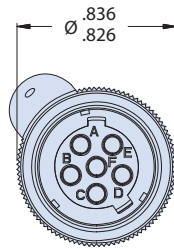
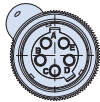

**U-229 Plug,
6 Crimp Contacts**

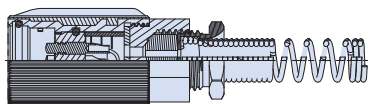
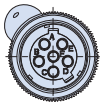

**U-229 Plug,
5 Solder Cup
Contacts**

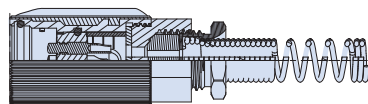
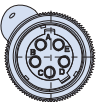

**U-229 Plug,
6 Solder Cup
Contacts**

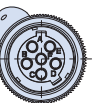

No. of Contacts	Contact Type	Ø Cable ± .010	MIL SPEC Part Number	Glenair Part Number	Mates With
5	Crimp (COTS)	.165	N/A	151-001-1-1	152-003-1 152-004-1 152-004-3
		.228	N/A	151-001-1-2	152-007-5 151-003-1 151-004-1
		.250	N/A	151-001-1-3	151-004-1 151-004-3
		.290	N/A	151-001-1-4	
		.320	N/A	151-001-1-5	
6	Crimp (COTS)	.165	N/A	151-001-2-1	152-003-2 152-004-2 152-004-4
		.228	N/A	151-001-2-2	152-007-6 151-003-2 151-004-2
		.250	N/A	151-001-2-3	151-004-4
		.290	N/A	151-001-2-4	
		.320	N/A	151-001-2-5	
5	Solder Cup (QPL)	.165	M55116/3-1	151-001-3-1	152-003-1 152-004-1 152-004-3
		.228	M55116/3-2	151-001-3-2	152-007-5 151-003-1 151-004-1
		.250	M55116/3-3	151-001-3-3	151-004-1 151-004-3
		.290	M55116/3-4	151-001-3-4	
		.320	M55116/3-5	151-001-3-5	
6	Solder Cup (QPL)	.165	M55116/4-1	151-001-4-1	152-003-2 152-004-2 152-004-4
		.228	M55116/4-2	151-001-4-2	152-007-6 151-003-2 151-004-2
		.250	M55116/4-3	151-001-4-3	151-004-4
		.290	M55116/4-4	151-001-4-4	
		.320	M55116/4-5	151-001-4-5	

X-ON Electronics

Largest Supplier of Electrical and Electronic Components

Click to view similar products for [Circular DIN Connectors](#) category:

Click to view products by [Glenair](#) manufacturer:

Other Similar products are found below :

[D38999/20MJ37PB](#) [75-190222-09G](#) [FRCIR030FP-36-10P-F80](#) [FRCIR08F-18-19S-F80](#) [FRCIR08R-36-7S-F80](#) [8R3006A18M0033](#) [PT05A-14-18SW\(023\)](#) [PT05A-14-5SX](#) [GTC01A-22-28P](#) [PT05A1832SW](#) [PT05A2041SX](#) [PT05SE1832SWLC](#) [PT05SE1832SYLC](#)
[GTC030-20-27PW-LC](#) [ACC06AF-20-23P\(003\)](#) [1210500311](#) [1210503216](#) [ACS00F-16-10S\(003\)](#) [ACS06AF-16-10P\(003\)](#) [D38999/42FE35AN](#)
[D38999/46WE6SN](#) [MS3100F22-23S](#) [MS3100R36-5S](#) [MS3101E28-21S](#) [MS3101E2821SX](#) [MS3102E184PW](#) [MS310314S-5P](#) [MS310314S-6P](#) [MS310314S-7P](#) [MS310322-8S](#) [MS3114F10-6P](#) [MS3116E8-4SW](#) [MS3122E10-6PW](#) [MS3456W28-21PZ-LC](#) [C18213N21](#) [CA3100E14S-9PB](#) [CA3100E14SA7P](#) [CA3100E16-10S](#) [CA3100E16S-8PBF80](#) [CA3100E18-1SBF80A176](#) [CA3100E20-7SB-F80-A176](#) [CA3100E22-14SB](#) [CA3100E22-14SBF80](#) [CA3100E22-19PBF80](#) [CA3100E22-22SB](#) [CA3100E22-22SBF80](#) [CA3100E22-2SBF80](#) [CA3100E22-7PB](#)
[CA3100E28-21PWB02](#) [CA3100E32-15PB](#)