



## Series 80 Mighty Mouse Environmental Backshell Ordering Information

370MS037, 370MS038, 370MB038 and 370MA038



Environmental backshells feature silicone o-rings for a watertight seal.

**Straight Entry** backshells are available with direct coupling or rotatable coupling.

**45° and 90°** adapters feature rotatable coupling nuts.

### MATERIALS

Adapter, Clamp, Nut and Saddles	Aluminum Alloy 6061-T6 or 300 Series Stainless Steel
O-Rings	Silicone Rubber
Hardware	300 Series Stainless Steel

### HOW TO ORDER

#### Sample Part Number

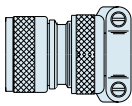
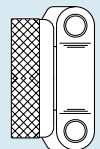
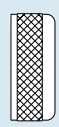
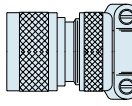
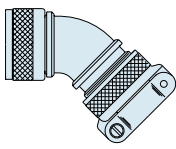
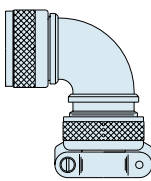
370MS037	C	10	05-	6	N																																																																																										
Part Number	Shell Material / Finish	Size Code	Cable Entry Code	Length	Clamp Style																																																																																										
 <b>370MS038</b> Straight Entry, Rotatable Coupling	<b>C</b> Aluminum / Black Anodize (Non-Conductive) RoHS Compliant	<table border="1"> <thead> <tr> <th>Size Code</th> <th>Thread Size</th> </tr> </thead> <tbody> <tr><td>05</td><td>.2500-32</td></tr> <tr><td>06</td><td>.3125-32</td></tr> <tr><td>11</td><td>.3750-32</td></tr> <tr><td>07</td><td>.4375-28</td></tr> <tr><td>08</td><td>.5000-28</td></tr> <tr><td>09</td><td>.5625-24</td></tr> <tr><td>10</td><td>.6250-24</td></tr> <tr><td>12</td><td>.6875-24</td></tr> <tr><td>13</td><td>.7500-20</td></tr> <tr><td>14</td><td>.9375-20</td></tr> <tr><td>17</td><td>1.1875-18</td></tr> </tbody> </table>	Size Code	Thread Size	05	.2500-32	06	.3125-32	11	.3750-32	07	.4375-28	08	.5000-28	09	.5625-24	10	.6250-24	12	.6875-24	13	.7500-20	14	.9375-20	17	1.1875-18	<table border="1"> <thead> <tr> <th rowspan="2">Cable Entry Code</th> <th colspan="2">Cable Sealing Diameter</th> </tr> <tr> <th>Max.</th> <th>Min.</th> </tr> </thead> <tbody> <tr><td>01-</td><td>.109</td><td>.031</td></tr> <tr><td>02-</td><td>.172</td><td>.078</td></tr> <tr><td>03-</td><td>.234</td><td>.140</td></tr> <tr><td>04-</td><td>.297</td><td>.203</td></tr> <tr><td>05-</td><td>.359</td><td>.265</td></tr> <tr><td>06-</td><td>.422</td><td>.328</td></tr> <tr><td>07-</td><td>.484</td><td>.390</td></tr> <tr><td>08-</td><td>.547</td><td>.453</td></tr> <tr><td>09-</td><td>.609</td><td>.515</td></tr> </tbody> </table>	Cable Entry Code	Cable Sealing Diameter		Max.	Min.	01-	.109	.031	02-	.172	.078	03-	.234	.140	04-	.297	.203	05-	.359	.265	06-	.422	.328	07-	.484	.390	08-	.547	.453	09-	.609	.515	Straight Entry 370MS Only <table border="1"> <thead> <tr> <th>Length Code</th> <th>Length (Inches)</th> </tr> </thead> <tbody> <tr><td>5</td><td>.625</td></tr> <tr><td>6</td><td>.750</td></tr> <tr><td>7</td><td>.875</td></tr> <tr><td>8</td><td>1.000</td></tr> <tr><td>9</td><td>1.125</td></tr> <tr><td>10</td><td>1.250</td></tr> <tr><td>11</td><td>1.375</td></tr> <tr><td>12</td><td>1.500</td></tr> <tr><td>13</td><td>1.625</td></tr> <tr><td>14</td><td>1.750</td></tr> <tr><td>15</td><td>1.875</td></tr> <tr><td>16</td><td>2.000</td></tr> <tr><td>17</td><td>2.125</td></tr> <tr><td>18</td><td>2.250</td></tr> <tr><td>19</td><td>2.375</td></tr> <tr><td>20</td><td>2.500</td></tr> </tbody> </table>	Length Code	Length (Inches)	5	.625	6	.750	7	.875	8	1.000	9	1.125	10	1.250	11	1.375	12	1.500	13	1.625	14	1.750	15	1.875	16	2.000	17	2.125	18	2.250	19	2.375	20	2.500	 Omit for screw clamp with saddle bars   <b>N</b> Compression Nut, Low Profile
		Size Code	Thread Size																																																																																												
05	.2500-32																																																																																														
06	.3125-32																																																																																														
11	.3750-32																																																																																														
07	.4375-28																																																																																														
08	.5000-28																																																																																														
09	.5625-24																																																																																														
10	.6250-24																																																																																														
12	.6875-24																																																																																														
13	.7500-20																																																																																														
14	.9375-20																																																																																														
17	1.1875-18																																																																																														
Cable Entry Code	Cable Sealing Diameter																																																																																														
	Max.	Min.																																																																																													
01-	.109	.031																																																																																													
02-	.172	.078																																																																																													
03-	.234	.140																																																																																													
04-	.297	.203																																																																																													
05-	.359	.265																																																																																													
06-	.422	.328																																																																																													
07-	.484	.390																																																																																													
08-	.547	.453																																																																																													
09-	.609	.515																																																																																													
Length Code	Length (Inches)																																																																																														
5	.625																																																																																														
6	.750																																																																																														
7	.875																																																																																														
8	1.000																																																																																														
9	1.125																																																																																														
10	1.250																																																																																														
11	1.375																																																																																														
12	1.500																																																																																														
13	1.625																																																																																														
14	1.750																																																																																														
15	1.875																																																																																														
16	2.000																																																																																														
17	2.125																																																																																														
18	2.250																																																																																														
19	2.375																																																																																														
20	2.500																																																																																														
 <b>370MS037</b> Straight Entry, Direct Coupling	<b>M</b> Aluminum / Electroless Nickel RoHS Compliant																																																																																														
 <b>370MB038</b> 45° Entry	<b>NF</b> Aluminum / Cadmium with Olive Drab Chromate																																																																																														
 <b>370MA038</b> 90° Entry	<b>ZN</b> Aluminum / Zinc-Nickel with Olive Drab Chromate																																																																																														
	<b>ZNU</b> Aluminum / Zinc-Nickel with Black Chromate																																																																																														
	<b>MT</b> Aluminum / Nickel-PTFE RoHS Compliant																																																																																														
	<b>Z1</b> Stainless Steel / Passivated RoHS Compliant																																																																																														

Dimensions in inches (millimeters) and are subject to change without notice.

# Series 80 Mighty Mouse Environmental Backshell Dimensions

370MS037, 370MS038, 370MB038 and 370MA038

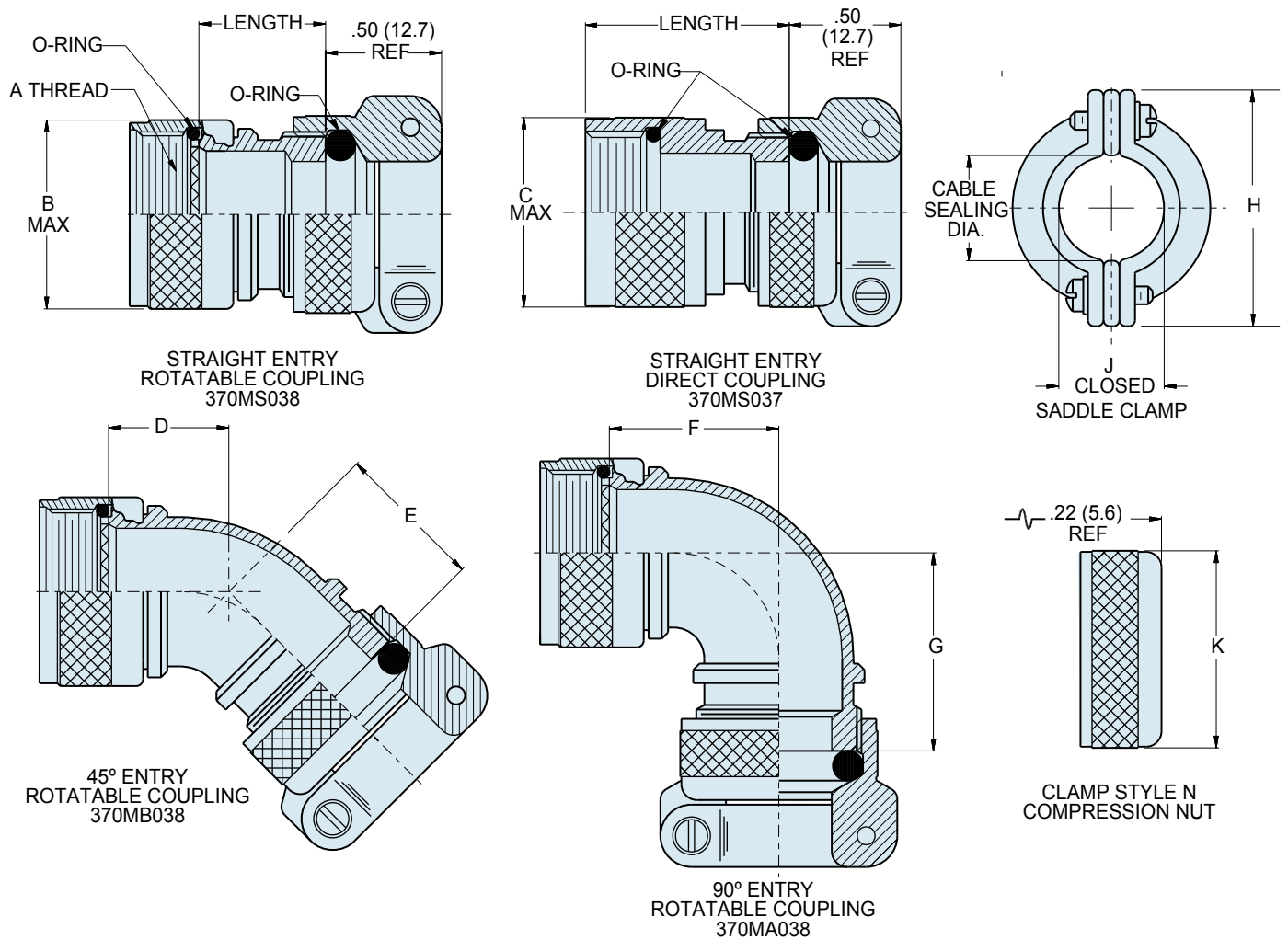

DIMENSIONS							
Size Code	A Thds.	B Max.		C Max.		Std. Length*	
		In.	mm.	In.	mm.	In.	mm.
05	.2500-32	.470	11.94	.350	8.89	.750	19.05
06	.3125-32	.530	13.46	.415	10.54	.750	19.05
11	.3750-32	.570	14.48	.465	11.68	.750	19.05
07	.4375-28	.637	16.18	.530	13.46	.750	19.05
08	.5000-28	.700	17.78	.595	15.11	.750	19.05
09	.5625-24	.758	19.25	.650	16.51	.750	19.05
10	.6250-24	.819	20.80	.715	18.16	.750	19.05
12	.6875-24	.896	22.76	.785	19.94	.880	22.35
13	.7500-20	.930	23.62	.830	21.08	.880	22.35
14	.9375-20	1.137	28.88	1.020	25.91	1.000	25.40
17	1.1875-18	1.280	32.51	1.387	35.23	1.130	28.70

\*Choose standard length for best availability

DIMENSIONS																
Cable Entry Code	Cable Sealing Dia.		D Max.		E Max.		F Max.		G Max.		H		Ø J Closed		Ø K	
	Max.	Min.	In.	mm.	In.	mm.	In.	mm.	In.	mm.	In.	mm.	In.	mm.	In.	mm.
01	.109	.031	.603	15.32	.581	14.76	.724	18.39	.702	17.83	.496	12.60	.110	2.79	.398	10.11
02	.172	.078	.603	15.32	.581	14.76	.724	18.39	.702	17.83	.582	14.78	.170	4.32	.460	11.68
03	.234	.140	.603	15.32	.581	14.76	.724	18.39	.702	17.83	.656	16.66	.230	5.84	.523	13.28
04	.297	.203	.629	15.98	.607	15.42	.786	19.96	.764	19.41	.726	18.44	.300	7.62	.585	14.86
05	.359	.265	.629	15.98	.607	15.42	.786	19.96	.764	19.41	.885	22.48	.360	9.14	.647	16.43
06	.422	.328	.655	16.64	.633	16.00	.848	21.54	.826	20.98	.952	24.18	.420	10.67	.710	18.03
07	.484	.390	.655	16.64	.633	16.00	.848	21.54	.826	20.98	1.018	25.86	.480	12.19	.773	19.63
08	.547	.453	.707	17.96	.685	17.40	.911	23.14	.889	22.58	1.084	27.53	.550	13.97	.835	21.21
09	.609	.515	.707	17.96	.685	17.40	.911	23.14	.889	22.58	1.148	29.16	.610	15.49	.897	22.78

Dimensions in inches (millimeters) and are subject to change without notice.

## X-ON Electronics

Largest Supplier of Electrical and Electronic Components

*Click to view similar products for [Circular MIL Spec Backshells](#) category:*

*Click to view products by [Glenair](#) manufacturer:*

Other Similar products are found below :

[60-036152-022](#) [610HS012M15](#) [M28840/504WA](#) [M28840/805WB](#) [M28840/809WA](#) [M28840/815WA](#) [M28840/816WA](#) [627AS017M14](#)  
[627MA124M14S](#) [655HS002NF11](#) [CW3899-000](#) [M85049/10-134S](#) [M85049/10-17S](#) [M85049/10-33S](#) [M85049/10-94W](#) [M85049/11-28N](#)  
[M85049/11-37N](#) [M85049/11-53N](#) [M85049/11-63N](#) [M85049/124-23W](#) [M85049/1720N04B](#) [M85049/1821W05C](#) [M85049/1825W06C](#)  
[M85049/1919N05](#) [M85049/23-74W](#) [M85049/24-71N](#) [M85049/25-47N](#) [M85049/25-94W](#) [M85049/27S12N](#) [M85049/39-11S](#) [M85049/39-17S](#)  
[M85049/39-9S](#) [M85049/6-10B](#) [M85049/6-19N](#) [M85049/6-20B](#) [M85049/77-20W04](#) [M85049/78-11N03](#) [M85049/78-15W02](#) [M85049/78-](#)  
[17N04](#) [M85049/78-19N05](#) [M85049/79-19N07](#) [M85049/79-25N04](#) [M85049/82-18N02](#) [M85049/82-22P02](#) [M85049/83-10W03](#) [M85049/84-](#)  
[20N03](#) [M85049/8-48N](#) [M85049/85-24N01](#) [M85049/85-24P01](#) [M85049/86-16P03](#)