

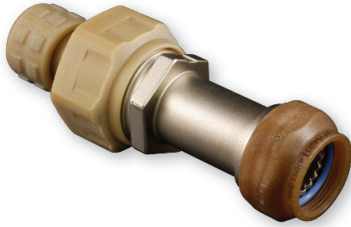

377-014

**Convoluted Tubing-to-Connector Backshell
for Fiber Optic MIL-DTL-38999 Series III & IV Connectors**

Convoluted tubing-to-connector backshell, fiber optic, composite with grommet



How To Order

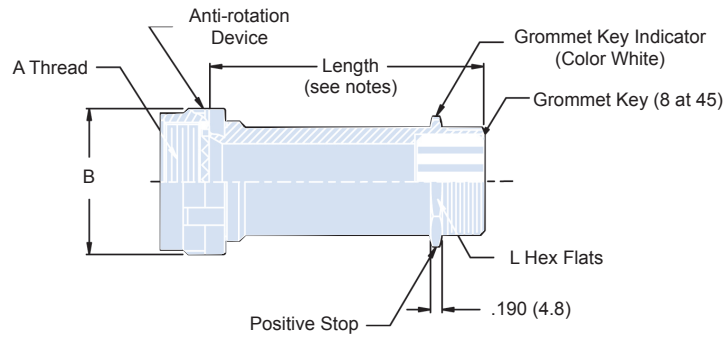
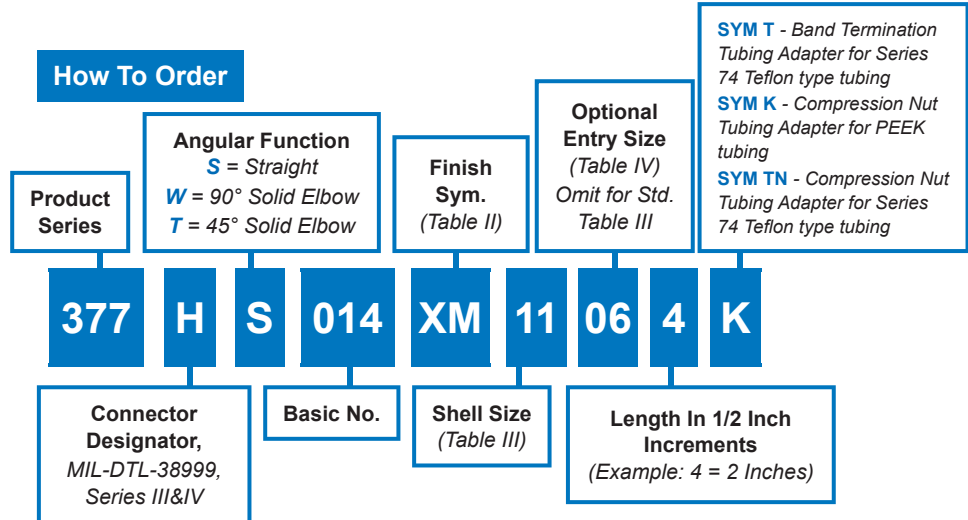

Sym S - Straight

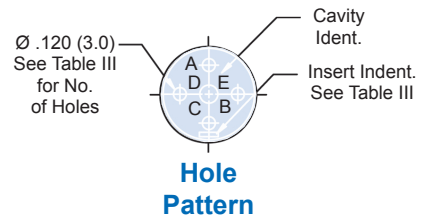
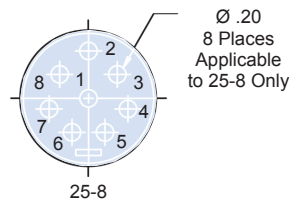

Material and Finish

- Adapters, Elbows, Coupling Nut, Nut: Hi-grade engineering thermoplastic/see table II
- Grommet, O-Ring: Fluorosilicone/N.A.
- Anti-Rotation Device: Corrosion resistant material/N.A.

Notes

- Standard minimum length: 1.5 inches, for shorter length consult factory.
- For Sealing Plugs, see Glenair drawing 687-142.

377-014

**Convolved Tubing-to-Connector Backshell
for Fiber Optic MIL-DTL-38999 Series III & IV Connectors**



Special Applications

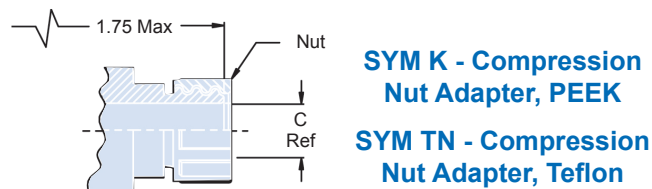
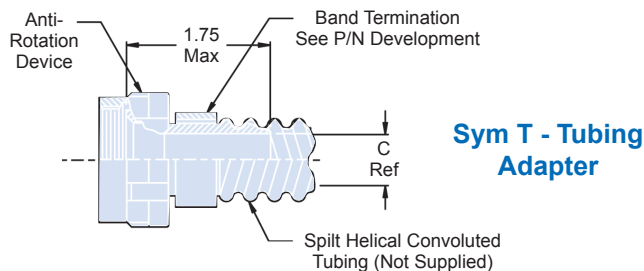
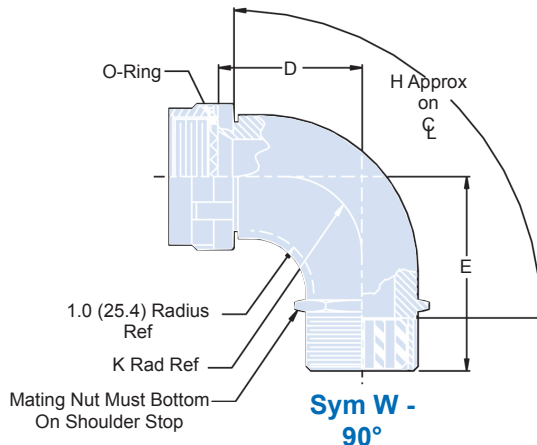
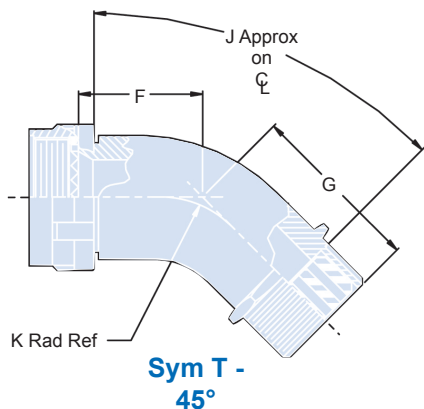

Shell Size	A Thread Iso Metric	B Max	Tubing Size	D Max	E Max	F Max	G Max	H Approx	J Radius	K Radius	L Flats	Insert Indent	Hole Count
11	M15 X 1 - 6H	1.00 (25.4)	3/8	1.78 (45.2)	1.93 (49.0)	1.33 (33.8)	1.56 (39.6)	2.23 (56.6)	2.09 (53.1)	1.20 (30.5)	.938 (23.8)	11-2	2
13	M18 X 1 - 6H	1.12 (28.4)	7/16	1.84 (46.7)	1.98 (50.3)	1.39 (35.3)	1.62 (41.1)	2.28 (57.9)	2.21 (56.1)	1.26 (32.0)	.938 (23.8)	13-4	4
15	M22 X 1 - 6H	1.25 (31.8)	1/2	1.90 (48.3)	2.08 (52.8)	1.45 (36.8)	1.68 (42.7)	2.45 (62.2)	2.33 (59.2)	1.32 (33.5)	.938 (23.8)	15-5	5
17	M25 X 1 - 6H	1.38 (35.1)	5/8	1.97 (50.0)	2.14 (54.4)	1.51 (38.4)	1.74 (44.2)	2.47 (62.7)	2.44 (62.0)	1.38 (35.1)	1.250 (31.8)	17-8	8
19	M28 X 1 - 6H	1.50 (38.1)	3/4	2.11 (53.6)	2.18 (55.4)	1.54 (39.1)	1.77 (45.0)	2.54 (64.5)	2.50 (63.5)	1.43 (36.3)	1.250 (31.8)	19-11	11
21	M31 X 1 - 6H	1.62 (41.0)	7/8	2.07 (52.6)	2.25 (57.2)	1.61 (40.9)	1.84 (46.7)	2.64 (67.1)	2.64 (67.1)	1.49 (37.8)	1.500 (38.1)	21-16	16
23	M34 X 1 - 6H	1.75 (44.5)	1	2.14 (54.4)	2.31 (58.7)	1.67 (42.4)	1.89 (48.0)	2.76 (70.1)	2.75 (69.9)	1.55 (39.4)	1.500 (38.1)	23-21	21
25	M37 X 1 - 6H	1.88 (47.8)	1	2.19 (55.6)	2.19 (55.6)	1.73 (43.9)	1.96 (49.8)	2.84 (72.1)	2.87 (72.9)	1.62 (41.1)	1.812 (46.0)	25-29	29
25-8	M37 X 1 - 6H	1.88 (47.8)	1 1/4	2.19 (55.6)	2.19 (55.6)	1.73 (43.9)	1.96 (49.8)	2.84 (72.1)	2.87 (72.9)	1.62 (41.1)	1.812 (46.0)	25-8	8
25-37	M37 X 1 - 6H	1.88 (47.8)	1 1/4	2.19 (55.6)	2.19 (55.6)	1.73 (43.9)	1.96 (49.8)	2.84 (72.1)	2.87 (72.9)	1.62 (41.1)	1.812 (46.0)	25-37	37

Entry Size	C Ref Sym T & TN	C Ref Sym K	Optional Conduit Size Ref.
03	.219 (5.6)	.188 (4.8)	9/32
04	.236 (6.0)	-	5/32
05	.250 (6.4)	.265 (6.7)	3/8
06	.338 (8.6)	.330 (8.4)	7/16
07	.398 (10.0)	.390 (9.9)	1/2
08	.523 (13.2)	.515 (13.1)	5/8
10	.648 (16.4)	.640 (16.3)	3/4
11	.648 (16.4)	.640 (16.3)	3/4
13	.778 (19.6)	.765 (19.4)	7/8
15	.875 (22.7)	.890 (22.6)	1
17	1.078 (28.0)	1.125 (28.6)	1 1/4

Sym	Finish Description
-	Dash (-) For No Plating
XB	No Plating - Black Color
XM	Electroless Nickel Backshell No Plating Supplied On Coupling Nut Or Rear Entry Components - Amber Color
XW	Cadmium Olive Drab Over Electroless Nickel Backshell - No Plating Supplied on Coupling Nut or Rear Entry Components - Amber Color
XMT	Copper Flash - GPS52-XMT (JCP-3)

F

X-ON Electronics

Largest Supplier of Electrical and Electronic Components

Click to view similar products for [Circular MIL Spec Backshells](#) category:

Click to view products by [Glenair](#) manufacturer:

Other Similar products are found below :

[5M2919-3DW](#) [5M2920-3CW](#) [5M2953-1HW](#) [60-036152-022](#) [610HS012M15](#) [M28840/504WA](#) [M28840/805WB](#) [M28840/809WA](#)
[M28840/815WA](#) [M28840/816WA](#) [627AS017M14](#) [62GB5851608S](#) [655HS002NF11](#) [CW3703-000](#) [CW3899-000](#) [M85049/10-134S](#)
[M85049/10-17S](#) [M85049/10-33S](#) [M85049/10-94W](#) [M85049/11-09W](#) [M85049/11-28N](#) [M85049/11-37N](#) [M85049/11-53N](#) [M85049/11-63N](#)
[M85049/118-20W](#) [M85049/124-23W](#) [M85049/124S09W](#) [M85049/126S23W](#) [M850491712W02](#) [M85049/1720N04B](#) [M85049/1817N06](#)
[M850491819W03](#) [M85049/1821W05C](#) [M85049/1825W06C](#) [M85049/1919N05](#) [M85049/1919W04](#) [M850491919W07](#) [M85049/23-59W](#)
[M85049/23-74W](#) [M8504924-5W](#) [M85049/24-71N](#) [M85049/25-47N](#) [M85049/25-94W](#) [M85049/27S12N](#) [M8504938-13S](#) [M85049/38-19S](#)
[M85049/39-11S](#) [M85049/39-17S](#) [M85049/39-9S](#) [M85049/3W4A2](#)