

**CONNECTOR DESIGNATORS**  
**A-F-H-L-S**  
**SELF-LOCKING**  
**ROTATABLE COUPLING**  
**TYPE F INDIVIDUAL AND/OR OVERALL SHIELD TERMINATION**

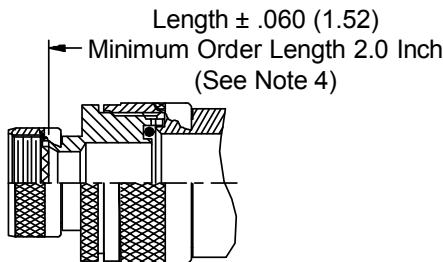

**STYLE 2 (STRAIGHT)**  
 See Note 1)

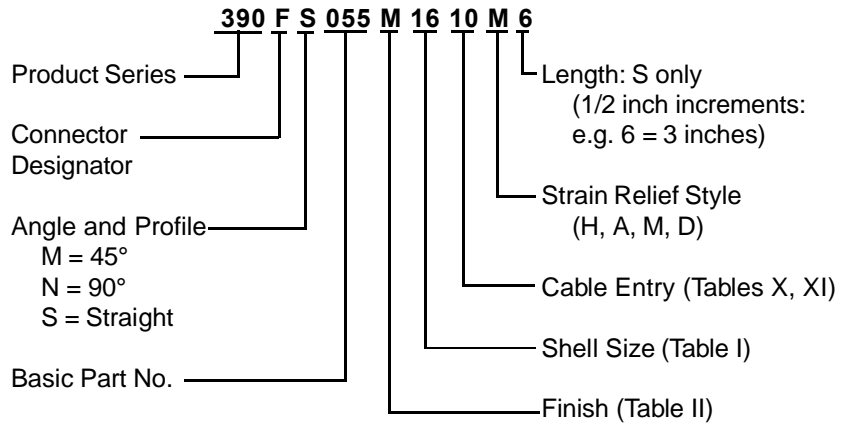
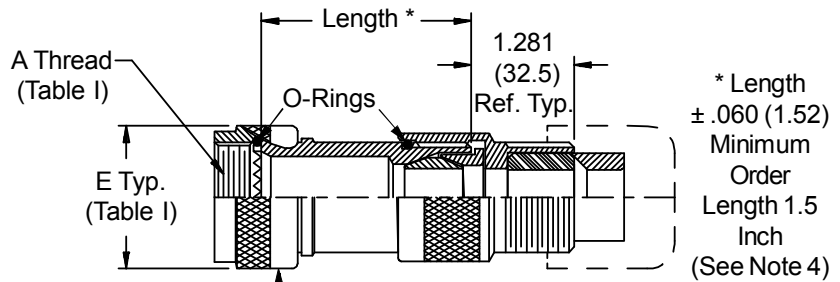

Anti-Rotation Device

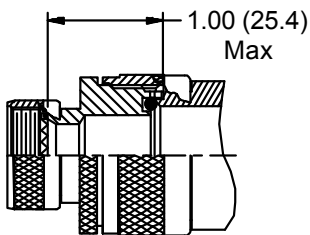

**STYLE 2 (45° & 90°)**  
 See Note 1)

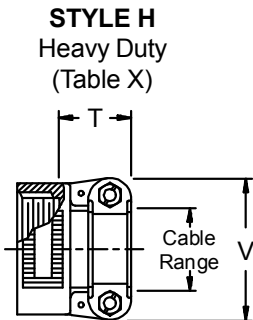
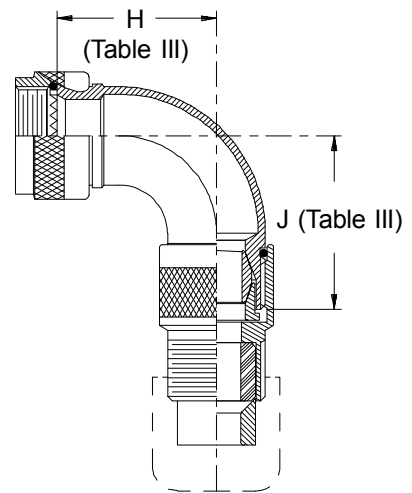
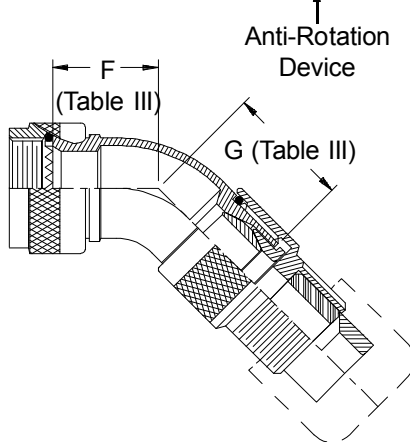

**STYLE H**  
 Heavy Duty (Table X)

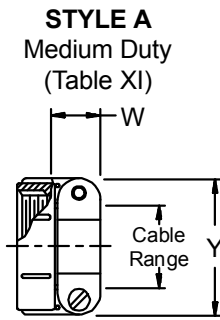

**STYLE A**  
 Medium Duty (Table XI)

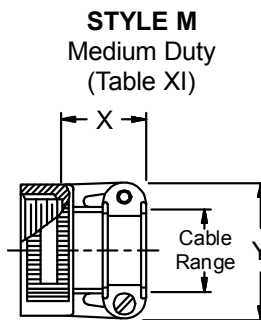

**STYLE M**  
 Medium Duty (Table XI)

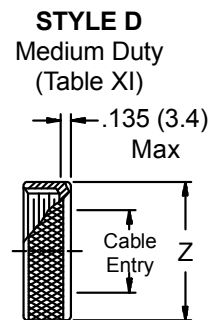

**STYLE D**  
 Medium Duty (Table XI)

**390-055**  
**Submersible EMI/RFI Cable Sealing Backshell**  
 with Strain Relief  
 Type F - Self-Locking Rotatable Coupling - Full Radius Profile



**TABLE III: ELBOW DIMENSIONS**

Shell Size		F	G	H	J
Conn. Desig.	A-F-L-S H	Max	Max	Max	Max
08		.968 (24.6)	1.095 (27.8)	1.281 (32.5)	1.287 (32.7)
10	11	1.031 (26.2)	1.145 (29.1)	1.406 (35.7)	1.411 (35.8)
12		1.094 (27.8)	1.195 (30.4)	1.531 (38.9)	1.537 (39.0)
14	15	1.156 (29.4)	1.245 (31.6)	1.656 (42.1)	1.761 (44.7)
16		1.218 (30.9)	1.300 (33.0)	1.781 (45.2)	1.787 (45.4)
18	19	1.250 (31.8)	1.350 (34.3)	1.906 (48.4)	1.911 (48.5)
20		1.312 (33.3)	1.400 (35.6)	2.031 (51.6)	2.037 (51.7)
22	23	1.344 (34.1)	1.455 (37.0)	2.156 (54.8)	2.161 (54.9)
24		1.406 (35.7)	1.505 (38.1)	2.281 (57.9)	2.287 (58.1)
28		1.594 (40.5)	1.594 (10.5)	2.594 (65.9)	2.594 (65.9)

See inside back cover fold-out or pages 13 and 14 for Tables I and II.

**TABLE X: CABLE ENTRY**

Dash No.	T Max	V Max	Cable Range	
			Min	Max
04	.780 (19.8)	.957 (24.3)	.125 (3.2)	.312 (7.9)
06	.780 (19.8)	1.145 (29.1)	.250 (6.4)	.437 (11.1)
08	.780 (19.8)	1.332 (33.8)	.387 (9.3)	.562 (14.3)
10	.780 (19.8)	1.332 (33.8)	.350 (8.9)	.625 (15.9)
12	.811 (20.6)	1.551 (39.4)	.500 (12.7)	.750 (19.1)
16	.905 (23.0)	1.770 (45.0)	.625 (15.9)	.937 (23.8)
20	1.092 (27.7)	2.113 (53.7)	.875 (22.2)	1.250 (31.8)
24	1.124 (28.5)	2.363 (60.0)	1.000 (25.4)	1.375 (34.9)
28	1.399 (35.5)	2.770 (70.4)	1.250 (31.8)	1.625 (41.3)
32	1.399 (35.5)	3.020 (76.7)	1.437 (36.5)	1.875 (47.6)

- When maximum cable entry (page 21) is exceeded, Style 2 will be supplied. Dimensions F, G, H and J will not apply. Please consult factory.
- Metric dimensions (mm) are indicated in parentheses.
- Cable range is defined as the accommodations range for the wire bundle or cable. Dimensions shown are not intended for inspection criteria.
- Consult factory for shorter lengths on straight backshells.
- Interface O-Ring not supplied with connector designator A.

**TABLE XI: CABLE ENTRY**

Dash No.	W Max	X Max	Y Max	Z Max	Cable Range	
					Min	Max
03*	.437 (11.1)	.760 (19.3)	.843 (21.4)	.630 (16.0)	.156 (4.0)	.250 (6.4)
04*	.437 (11.1)	.760 (19.3)	.906 (23.0)	.755 (19.2)	.188 (4.8)	.312 (7.9)
06*	.500 (12.7)	.760 (19.3)	1.093 (27.8)	.942 (23.9)	.281 (7.1)	.438 (11.1)
08	.563 (14.3)	.760 (19.3)	1.187 (30.1)	1.067 (27.1)	.387 (9.3)	.562 (14.3)
10	.563 (14.3)	.760 (19.3)	1.281 (32.5)	1.192 (30.3)	.375 (9.5)	.625 (15.9)
12	.563 (14.3)	.760 (19.3)	1.500 (38.1)	1.380 (35.1)	.438 (11.1)	.750 (19.1)
16	.656 (16.7)	1.073 (27.3)	1.719 (43.7)	1.535 (39.0)	.625 (15.9)	.938 (23.8)
20	.656 (16.7)	1.323 (33.6)	2.062 (52.4)	1.848 (46.9)	.875 (22.2)	1.250 (31.8)
24	.656 (16.7)	1.323 (33.6)	2.312 (58.7)	2.255 (57.3)	1.000 (25.4)	1.375 (34.9)
28	1.188 (30.2)	1.572 (39.9)	2.719 (69.1)	2.505 (63.6)	1.250 (31.8)	1.625 (41.3)
32*	1.187 (30.1)	1.572 (39.9)	2.969 (75.4)	2.755 (70.0)	1.437 (36.5)	1.875 (47.6)
40*	1.125 (28.6)	1.572 (39.9)	3.531 (89.7)	3.255 (82.7)	1.875 (47.6)	2.375 (60.3)

\* Not available in Style M clamp.

**TABLE I - BACKSHELL INTERFACE DIMENSIONS**

CONNECTOR DESIGNATOR											A THREAD*	B	C	D	E
A	C*	D	E	F	G	H	J	K	L	S	REFERENCE	DIA MAX	DIA MAX	DIA MAX	DIA MAX
		08	08	08 [9]				08	08	08	7/16 - 28 UNEF	.590 (15.)	.650 (16.5)	.770 (19.6)	.690 (17.5)
						09 [A]					M12 x 1 - 6H	.650 (16.5)	.770 (19.6)		.940 (24.8)
08							08 [A]	10			1/2 - 20 UNF	.650 (16.5)	.650 (16.5)		.690 (17.5)
											1/2 - 28 UNEF	.650 (16.5)	.770 (19.6)	.770 (19.6)	
03		10	10	10 [11]				11	10	10	9/16 - 24 UNEF	.720 (18.3)	.770 (19.6)	.890 (22.6)	.820 (20.8)
						11 [B]					M15 x 1 - 6H	.770 (19.6)	.820 (20.8)		1.060 (26.9)
10								12 [13]			5/8 - 24 UNEF	.770 (19.6)	.770 (19.6)	.890 (22.6)	.820 (20.8)
								10 [B]			5/8 - 28 UN	.770 (19.6)	.890 (22.6)		
		12		12 [13]					12	12	11/16 - 24 UNEF	.840 (21.3)	.890 (22.6)	1.020 (25.9)	.940 (23.8)
						13 [C]					M18 x 1 - 6H	.890 (22.6)	.940 (23.9)		1.170 (29.7)
12 [7]	12		12		11 [A]			14 [15]			3/4 - 20 UNEF	.970 (24.6)	.940 (23.9)	1.020 (25.9)	.940 (23.8)
		14	14	14 [15]					14	14	13/16 - 20 UNEF	.970 (24.6)	1.020 (29.2)	1.150 (29.2)	1.060 (26.9)
						15 [D]					M22 x 1 - 6H	1.030 (26.2)	1.070 (26.2)		1.290 (32.7)
14 [12]	14				13 [B]			16 [17]			7/8 - 20 UNEF	1.090 (27.7)	1.020 (25.9)	1.150 (29.2)	1.060 (26.9)
								14 [D]			7/8 - 28 UN	1.030 (26.2)	1.150 (29.2)		
		16	16	16 [17]					16	16	15/16 - 20 UNEF	1.090 (27.7)	1.150 (29.2)	1.260 (32.0)	1.170 (29.7)
						17 [E]					M25 x 1 - 6H	1.150 (29.2)	1.210 (30.7)		1.420 (36.1)
16 [19]	16				15 [C]			18			1 - 20 UNEF	1.220 (29.2)	1.210 (30.7)	1.230 (31.2)	1.170 (29.7)
								16 [E]			1 - 28 UN	1.150 (29.2)	1.360 (34.5)		
18 [27]		18	18	18 [19]					18	18	1 1/16 - 18 UNEF	1.220 (31.0)	1.230 (31.2)	1.400 (35.6)	1.290 (32.7)
						19 [F]					M28 x 1 - 6H	1.280 (32.5)	1.360 (34.5)		1.540 (39.1)
	18				17 [D]			20			1 1/8 - 18 UNEF	1.340 (34.0)	1.360 (34.5)	1.360 (34.5)	
								18 [F]			1 1/8 - 28 UN	1.280 (32.5)	1.480 (37.6)		
20 [37]		20	20	20 [21]					20	20	1 3/16 - 18 UNEF	1.340 (34.0)	1.360 (34.5)	1.530 (38.9)	1.420 (36.0)
						21 [G]					M31 x 1 - 6H	1.410 (35.8)	1.480 (37.6)		1.670 (42.4)
	20				19 [E]			22			1 1/4 - 18 UNEF	1.470 (37.3)	1.530 (38.9)	1.480 (37.6)	
								20 [G]			1 1/4 - 28 UN	1.410 (35.8)	1.600 (40.6)		
22		22	22	22 [23]					22	22	1 5/16 - 18 UNEF	1.470 (37.3)	1.480 (37.6)	1.600 (40.6)	1.540 (39.1)
						23 [H]					M34 x 1 - 6H	1.530 (38.9)	1.600 (40.6)		2.010 (51.1)
	22							24			1 3/8 - 18 UNEF	1.590 (40.4)		1.600 (40.6)	
								22 [H]			1 3/8 - 28 UN	1.530 (38.9)	1.730 (43.9)		
24		24	24	24 [25]	23 [F]				24	24	1 7/16 - 18 UNEF	1.590 (40.4)	1.730 (43.9)	1.940 (49.3)	1.660 (42.2)
						25 [J]					M37 x 1 - 6H	1.660 (42.2)	1.700 (43.2)		2.120 (53.8)
61								24 [J]			1 1/2 - 18 UNEF	1.660 (42.2)	1.670 (42.4)		
											1 1/2 - 28 UN	1.660 (42.2)	1.940 (49.3)		
					25 [G]						1 9/16 - UNEF		1.820 (46.2)		
	24							28			1 5/8 - UNEF	1.840 (46.7)		1.940 (49.3)	
28											1 3/4 - 18 UNS	1.970 (50.0)	1.970 (50.0)		2.010 (51.1)
	28				29 [H]			32			1 7/8 - 16 UN	2.090 (53.1)	2.190 (55.6)	2.190 (55.6)	
32											2 - 18 UNS	2.280 (57.9)	2.220 (56.4)		2.260 (57.4)
	32				33 [J]						2 1/16 - 16 UNS	2.340 (59.4)	2.440 (62.0)	2.440 (62.0)	
								36			2 1/8 - 16 UN	2.340 (59.4)		2.440 (62.0)	
36											2 1/4 - 16 UN	2.530 (64.3)	2.47 (62.7)		2.530 (64.3)
	36										2 5/16 - 16 UNS	2.590 (65.8)		2.690 (68.3)	
								40			2 3/8 - 16 UN	2.590 (65.8)		2.690 (68.3)	
40											2 1/2 - 16 UN	2.780 (70.6)	2.720 (69.1)		3.040 (77.2)
	40										2 5/8 - 16 UN	2.910 (73.9)		2.930 (74.4)	
44											2 3/4 - 16 UN	3.030 (77.0)	2.970 (75.4)		
	44										2 7/8 - 16 UN	3.160 (80.3)			
48											3 - 16 UN	3.220 (81.8)	3.220 (81.8)		
	48										3 1/16 - 16 UN	3.410 (86.6)			

\* Code C, MIL-C-22992, Left-Hand Thread. Connector designations depicted thus [ ] are for reference only and are not to be used in part number development.

**BACKSHELL INTERFACE STANDARDS (See pages 15-17 for more information)**

DESIG. SPEC.	SERIES	DESIG. SPEC.	SERIES	DESIG. SPEC.	SERIES	DESIG. SPEC.	SERIES
A	MIL-DTL-5015 MS3400	A	PATT 602	G	MIL-C-28840	L	EN3372
	MIL-DTL-26482 2	B	MIL-DTL-5015 MS3100	H	MIL-DTL-38999 III & IV		JN 1003
	AS81703 3	C	MIL-C-22992 MS173XX		EN3645		LN 29729
	MIL-DTL-83723 I & III	D	MIL-DTL-26482 1	J	MIL-C-81511 1, 2, 3 & 4		NFC93422
	40M39569	E	MIL-DTL-26500 Aluminum		VG95329		PAN 6433-2
	DEF 5326-3	F	MIL-DTL-38999 I & II	K	MIL-DTL-83723 I		PATT 615
	EN 2997, 3646		40M38277				VG 96912
	ESC 10, 11		PAN 6433-1			S	PATT 105
	LN 29504		PATT 614				PATT 603
	NFC93422 HE302		PATT 616				PATT 608
	PAN 6432-1, -2		NFC93422 HE308, 9				



## Reference Information Standard Materials and Finishes

**TABLE II - STANDARD FINISHES**

GLENAIR SYMBOL	M85049 SYMBOL REFERENCE ONLY	FINISH	SPECIFICATION(S)
A		Cadmium Plate, Bright	AMS-QQ-P-416, Type I, Class 2
B		Cadmium Plate, Olive Drab	AMS-QQ-P-416, Type II, Class 3
C*	A	Anodize, Black	AMS-A-8625, Type II, Class 2
G*		Hard Coat, Anodic	AMS-A-8625, Type III, Class 1
J		Iridite, Gold Over Cadmium Plate Over Electroless Nickel	MIL-C-5541, Class 3 AMS-QQ-P-416, Type II, Class 3 over AMS-C-26074, Class 4, Grade B
LF		Cadmium Plate, Bright Over Electroless Nickel	1000 Hour Corrosion Resistance
M	N	Electroless Nickel	AMS-C-26074, Class 4, Grade B
N		Cadmium Plate, Olive Drab Over Electroless Nickel	AMS-QQ-P-416, Type II, Class 3 over Electroless Nickel AMS-C-26074
NC		Zinc Cobalt, Dark Olive Drab	96 Hour Corrosion Resistance
NF	W	Cadmium Plate, Olive Drab Over Electroless Nickel	1000 Hour Corrosion Resistance
T		Cadmium Plate, Bright Over Electroless Nickel	AMS-QQ-P-416, Type I, Class 3 ASTMB 733-90, SC2, Type I, Class 5, MIL-C-26074***
U		Cadmium Plate, Black	AMS-QQ-P-416, Type II, Class 3
ZU**		Cadmium Plate, Black	AMS-QQ-P-416, Type II, Class 3
ZN		Zinc-Nickel Alloy, Olive Drab	ASTMB 841-91, Over Electroless Nickel 1000 Hour Salt Spray

\* Anodize finish; not suitable for EMI Shielding or grounding applications.  
\*\* Applicable to corrosion resisting steel backshells and accessories. Consult factory for other available finishes.

The following standard materials are used for the majority of Glenair backshells and connector accessories. However, backshell components are not limited to those items listed, but are representative of

the elements used in Glenair's general accessory products. Contact Glenair for applicable specifications on items not listed below.

### STANDARD MATERIALS - BACKSHELLS AND ACCESSORIES

COMPONENT	MATERIAL	SPECIFICATION
Machined components: such as backshell bodies, fabricated elbows, protective covers, rotatable couplers, dummy stowage receptacles, lock nuts, G-spring support rings, EMI ground rings, grommet followers, etc.	Aluminum	AMS-QQ-A-200 ASTMB221, 209
Die cast components: such as angular backshells, strain relief backshells, strain relief bodies, strain relief saddles, special EMI ground rings, etc.	Aluminum	QQ-A-591 ASTMB85, 26
Backshells or strain reliefs: available in optional corrosion resisting steel; and hardware: such as screws, washers, rivets, wire rope, sash chain, band straps, etc.	Corrosion Resisting Steel	ASTMA582 (300 Series) AMS-QQ-S-763
Elastomeric seals: such as O-rings, cable jacket seals, grommets, etc.	Silicone	A-A-59588
	Fluorosilicone	MIL-DTL-25988
Anti-friction and thrust washers	Fluoropolymer	TFE
Anti-rotation device	Corrosion Resistant Material	N/A

#### BODY STRAP

Glenair offers an optional stainless steel body strap for attaching protective covers as illustrated. To specify body strap, add suffix letter C to the end of the part number. For example 360AS001M1610M6C.



2-56 Screw and Nut

#### NOTES

On all length callouts, tolerance is  $\pm .060$  unless otherwise specified.

Unless otherwise specified, the following other dimensional tolerances will apply:

- .xx =  $\pm .03$  (0.8)
- .xxx =  $\pm .015$  (0.4)
- Lengths =  $\pm .060$  (1.52)
- Angles =  $\pm 5^\circ$

Metric dimensions (mm) are indicated in parentheses

**NOTE: For your convenience these tables have been reproduced inside the back cover fold-out.**

## Glenair Backshell and Accessory Material and Finish Options

Backshell and accessory base materials, plating options, specifications and codes

Code	Material	Finish	Finish Specification
<b>A</b>	Aluminum	Cadmium, No Chromate	SAE-AMS-QQ-P-416 Type I Class 3
<b>AB</b>	Marine Bronze	Unplated	
<b>AL</b>	Aluminum	AlumiPlate, Clear Chromate	MIL-DTL-83488, Class 2, Type II over electroless nickel
<b>B</b>	Aluminum	Cadmium, Olive Drab	SAE-AMS-QQ-P-416 Type II Class 3
<b>C</b>	Aluminum	Anodize, Black	AMS-A-8625 Type II Class 2
<b>E</b>	Aluminum	Chem Film	MIL-DTL-5541 Type 1 Class 3
<b>G</b>	Aluminum	Anodize, Hardcoat	AMS-A-8625 Type III, Class 1, .001" thick
<b>J</b>	Aluminum	Cadmium, Gold	SAE-AMS-QQ-P-416 Type II, Class 2 over electroless nickel
<b>JF</b>	Aluminum	Cadmium, Gold	SAE-AMS-QQ-P-416 Type II, Class 2 over electroless nickel
<b>LF</b>	Aluminum	Cadmium, Clear	SAE-AMS-QQ-P-416 Type II Class 2 over electroless nickel
<b>M</b>	Aluminum	Electroless Nickel	AMS-C-26074 Class 4 Grade B; ASTM-B-733, SC 2, Type IV
<b>MT</b>	Aluminum	Nickel-PTFE	AMS2454
<b>N</b>	Aluminum	Cadmium, Olive Drab	SAE-AMS-QQ-P-416 Type II Class 3 over electroless nickel
<b>NC</b>	Aluminum	Zinc-Cobalt, Olive Drab	ASTM B 840 Grade 6 Type D over electroless nickel
<b>NF</b>	Aluminum	Cadmium, Olive Drab	SAE-AMS-QQ-P-416 Type II Class 2 over electroless nickel
<b>P</b>	Stainless Steel	Electrodeposited Nickel	SAE-AMS-QQ-N-290 Class 1 Grade F
<b>T</b>	Aluminum	Cadmium, No Chromate	SAE-AMS-QQ-P-416 Type I Class 3
<b>TP2</b>	Titanium	Electrodeposited Nickel	SAE-AMS-QQ-N-290 Class 1 Grade F
<b>U</b>	Aluminum	Cadmium, Black	SAE-AMS-QQ-P-416 Type I Class 3
<b>UC</b>	Aluminum	Zinc-Cobalt, Black	ASTM B 840 Grade 6 Type D over electroless nickel
<b>UCR</b>	Aluminum	Zinc-Cobalt, Black	ASTM B 840 Grade 6 Type D over electroless nickel
<b>UF</b>	Aluminum	Cadmium, Black	SAE-AMS-QQ-P-416 Type II Class 2 over electroless nickel
<b>XAL</b>	Composite	AlumiPlate	MIL-DTL-86448, Class 2, Type II over electroless nickel
<b>XB</b>	Composite	Unplated Black	
<b>XM</b>	Composite	Electroless Nickel	AMS-C-26074
<b>XMT</b>	Composite	Nickel-PTFE	GMS-002 Class 2 Type II
<b>XO</b>	Composite	Unplated Light Brown	
<b>XW</b>	Composite	Cadmium, Olive Drab	SAE-AMS-QQ-P-416 Type II Class 3 over electroless nickel
<b>XZN</b>	Composite	Zinc-Nickel, Black	ASTM B841 Grade 5 over electroless nickel
<b>Z1</b>	Stainless Steel	Passivate	SAE-AMS-SAE-AMS-QQ-P-35 Type VI
<b>Z2</b>	Aluminum	Gold	MIL-DTL-45204 Class 1 over electroless nickel
<b>ZC</b>	Stainless Steel	Zinc-Cobalt, Black	ASTM-B840, Grade 6
<b>ZCR</b>	Stainless Steel	Zinc-Cobalt, Black	ASTM-B840, Grade 6
<b>ZL</b>	Stainless Steel	Electrodeposited Nickel	SAE-AMS-QQ-N-290 Class 1 Grade F
<b>ZM</b>	Stainless Steel	Electroless Nickel	AMS-C-26074 Class 1 Grade A
<b>ZMT</b>	Stainless Steel	Nickel-PTFE	GMF-002 Type II Class 3
<b>ZN</b>	Aluminum	Zinc-Nickel, Olive Drab	ASTM B841 Grade 5 over electroless nickel
<b>ZNU</b>	Aluminum	Zinc-Nickel, Black	ASTM B841 Grade 5 over electroless nickel
<b>ZR</b>	Aluminum	Zinc-Nickel, Black	ASTM B841 Grade 5 over electroless nickel
<b>ZU</b>	Stainless Steel	Cadmium, Black	SAE-AMS-QQ-P-416 Type II Class 3
<b>ZW</b>	Stainless Steel	Cadmium, Olive Drab	SAE-AMS-QQ-P-416 Type II Class 2 over electroless nickel

## X-ON Electronics

Largest Supplier of Electrical and Electronic Components

*Click to view similar products for [Circular MIL Spec Backshells](#) category:*

*Click to view products by [Glenair](#) manufacturer:*

Other Similar products are found below :

[60-036152-022](#) [610HS012M15](#) [M28840/504WA](#) [M28840/805WB](#) [M28840/809WA](#) [M28840/815WA](#) [M28840/816WA](#) [627AS017M14](#)  
[627MA124M14S](#) [655HS002NF11](#) [CW3899-000](#) [M85049/10-134S](#) [M85049/10-17S](#) [M85049/10-33S](#) [M85049/10-94W](#) [M85049/11-28N](#)  
[M85049/11-37N](#) [M85049/11-53N](#) [M85049/11-63N](#) [M85049/124-23W](#) [M85049/1720N04B](#) [M85049/1821W05C](#) [M85049/1825W06C](#)  
[M85049/1919N05](#) [M85049/23-74W](#) [M85049/24-71N](#) [M85049/25-47N](#) [M85049/25-94W](#) [M85049/27S12N](#) [M85049/39-11S](#) [M85049/39-17S](#)  
[M85049/39-9S](#) [M85049/6-10B](#) [M85049/6-19N](#) [M85049/6-20B](#) [M85049/77-20W04](#) [M85049/78-11N03](#) [M85049/78-15W02](#) [M85049/78-](#)  
[17N04](#) [M85049/78-19N05](#) [M85049/79-19N07](#) [M85049/79-25N04](#) [M85049/82-18N02](#) [M85049/82-22P02](#) [M85049/83-10W03](#) [M85049/84-](#)  
[20N03](#) [M85049/8-48N](#) [M85049/85-24N01](#) [M85049/85-24P01](#) [M85049/86-16P03](#)