

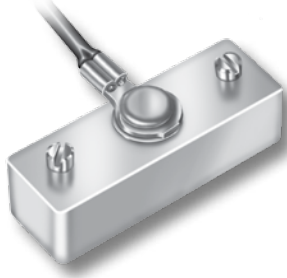

## 500-017 & 500-037 Micro-D Metal Protective Cover



Choose **Metal Protective Covers** for full environmental protection.

**Silicone Rubber gasket** provides a watertight seal.

Use with **M83513 Type Metal Shell Micro-D Connectors**

### MATERIALS & FINISHES

Shell	Aluminum Alloy 6061 -T6
Gasket	Silicone Rubber
Hardware	300 Series Stainless Steel, Passivated

### SELECT A PROTECTIVE COVER STYLE

Style 1

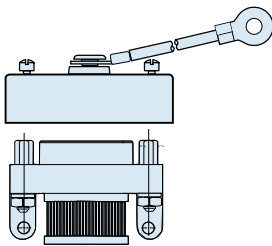

Use With Micro-D Connectors With Jackposts  
Not for rear panel mounted connectors.

Style 2

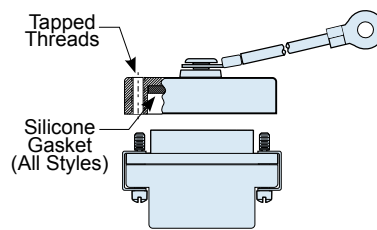

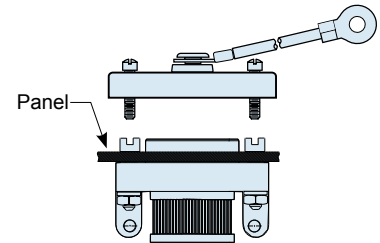

Use With Micro-D Connectors With Jackscrews

Style 3

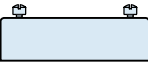

Use With Rear-Panel Mounted Micro-D Connectors

### HOW TO ORDER STYLE 1 AND STYLE 2 PROTECTIVE COVERS

Series	Shell Finish	Connector Size	Hardware Option	Lanyard Option	Lanyard Length	Ring Terminal Ordering Code
500-017	C – Black Anodize	09	<p><b>STYLE 1</b></p>  <p>Fits Micro-D's With Jackposts Cover has Jackscrews</p> <p>MB – Fillister Head Jackscrew MH – Hex Head Jackscrew</p> <p><b>STYLE 2</b></p>  <p>Fits Micro-D's With Jackscrews Cover has Tapped Female Threads</p> <p>F – Female Threads</p> <p>(STYLE 3: see next page)</p>	<p>N – No Lanyard G – Flexible Nylon Rope F – Wire Rope, Nylon Jacket H – Wire Rope, Hi-Temp Teflon Jacket</p>	<p>Length in One Inch Increments</p> <p>Example: "6" equals six inches.</p>	<p>06 – .125 (3.2) 01 – .140 (3.6) 05 – .167 (4.2) 04 – .197 (5.0)</p> <p>I.D. of Ring Terminal</p>
		15				
	E – Chem Film	21				
		25				
	J – Cadmium, Yellow Chromate	31				
		37				
		51				
	M – Electroless Nickel	51-2				
		67				
	NF – Cadmium, Olive Drab	69				
Z2 – Gold	100					
<b>Sample Part Number</b>						
500-017	M	25	MB	F	4	- 06

# 500-017 & 500-037 Micro-D Metal Protective Cover



MIL-DTL-83513  
Micro-D

## HOW TO ORDER STYLE 3 PROTECTIVE COVERS FOR REAR MOUNT CONNECTORS

Series	Shell Finish	Connector Size	Panel Thickness Option	Hardware Option	Lanyard Option	Ring Terminal Ordering Code	Length (In Inches)	
500-037	C - Black Anodize	09	R1 - .031 (0.79) Panel	<b>STYLE 3</b>  Fits Micro-D's With Jackposts B - Fillister Head Jackscrew H - Hex Head Jackscrew	N - No Lanyard G - Flexible Nylon Rope F - Wire Rope, Nylon Jacket H - Wire Rope, Hi-Temp Teflon Jacket	06 - .125 (3.2)	2 - Inches  (Omit for Standard 4-inch Length)	
		15	R2 - .047 (1.19) Panel			01 - .140 (3.6)		
	E - Chem Film	21	R3 - .062 (1.57) Panel			05 - .167 (4.2)		
		J - Cadmium, Yellow Chromate	25			R4 - .093 (2.36) Panel		04 - .197 (5.0)
			31					
	M - Electroless Nickel	37						I.D. of Ring Terminal
		51-2						
	NF - Cadmium, Olive Drab	51						
		67						
	Z2 - Gold	69						
100								

### Sample Part Number

500-037	J	31	R4	B	G	- 06	2
---------	---	----	----	---	---	------	---

## PROTECTIVE COVER DIMENSIONS

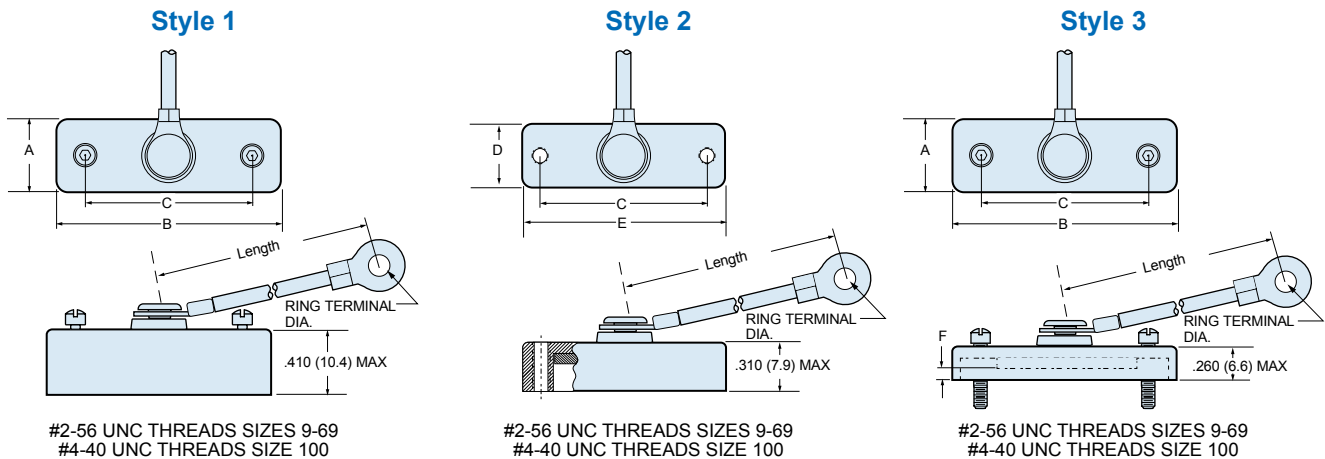

For Micro-D Connectors With Jackposts

For Micro-D Connectors With Jackscrews

For Rear-Panel Mounted Micro-D

Size	A Max.		B Max.		C		D Max.		E Max.		F		
	In.	mm.	In.	mm.	In.	mm.	In.	mm.	In.	mm.	Panel Thickness	In.	mm.
9	.453	11.5	.930	23.6	.565	14.35	.380	9.65	.795	20.19	R1	.126	3.2
15	.453	11.5	1.080	27.4	.715	18.16	.380	9.65	.945	24.00	R2	.110	2.8
21	.453	11.5	1.230	31.2	.865	21.97	.380	9.65	1.095	27.81	R3	.095	2.4
25	.453	11.5	1.330	33.8	.965	24.51	.380	9.65	1.195	30.35	R4	.064	1.6
31	.453	11.5	1.480	37.6	1.115	28.32	.380	9.65	1.345	34.16			
37	.453	11.5	1.630	41.4	1.265	32.13	.380	9.65	1.495	37.97			
51	.496	12.6	1.580	40.1	1.215	30.86	.420	10.67	1.445	36.70			
51-2	.453	11.5	1.980	50.3	1.615	41.02	.380	9.65	1.845	46.86			
67	.453	11.5	2.380	60.5	2.015	51.18	.380	9.65	2.245	57.02			
69	.496	12.6	1.880	47.8	1.515	38.48	.420	10.67	1.745	44.32			
100	.539	13.7	2.315	58.8	1.800	45.72	.470	11.94	2.180	55.37			

## X-ON Electronics

Largest Supplier of Electrical and Electronic Components

*Click to view similar products for [D-Sub Tools & Hardware](#) category:*

*Click to view products by [Glenair](#) manufacturer:*

Other Similar products are found below :

[173112-0667](#) [173112-0759](#) [173112-0967](#) [173112-0291](#) [173112-0456](#) [000-01-09-132](#) [000-01-21-132](#) [000-01-31-162](#) [572019-00105-70](#)  
[000-01-37-162](#) [621-250-113-115](#) [D20418-2R](#) [D20418-J3F](#) [70521CLF](#) [70524BLF](#) [70527BLF](#) [70527CLF](#) [F1042-1PLAH](#) [750643-1](#) [780-010-06G4-00C](#) [780-518-50SG6-WS](#) [863004ATLF](#) [86552009](#) [86553115TLF](#) [86553117TLF](#) [86553156LF](#) [FSGK1/5](#) [980-8554-000](#) [980-8555-000](#)  
[980-8557-000](#) [980-8558-000](#) [1230032-1](#) [1-5021101-2](#) [15-000050](#) [1589283-4](#) [160-000-005R031](#) [16-000230](#) [160-020-109R000](#) [160-025-004R031](#) [160-015-003R031](#) [160-020-209R000](#) [160X10909X](#) [164C03939A](#) [177-505-A-2-2](#) [177-505-C-4-4](#) [179-013-1H](#) [1-966830-8](#) [21018-621028-3](#) [213622-5](#)