

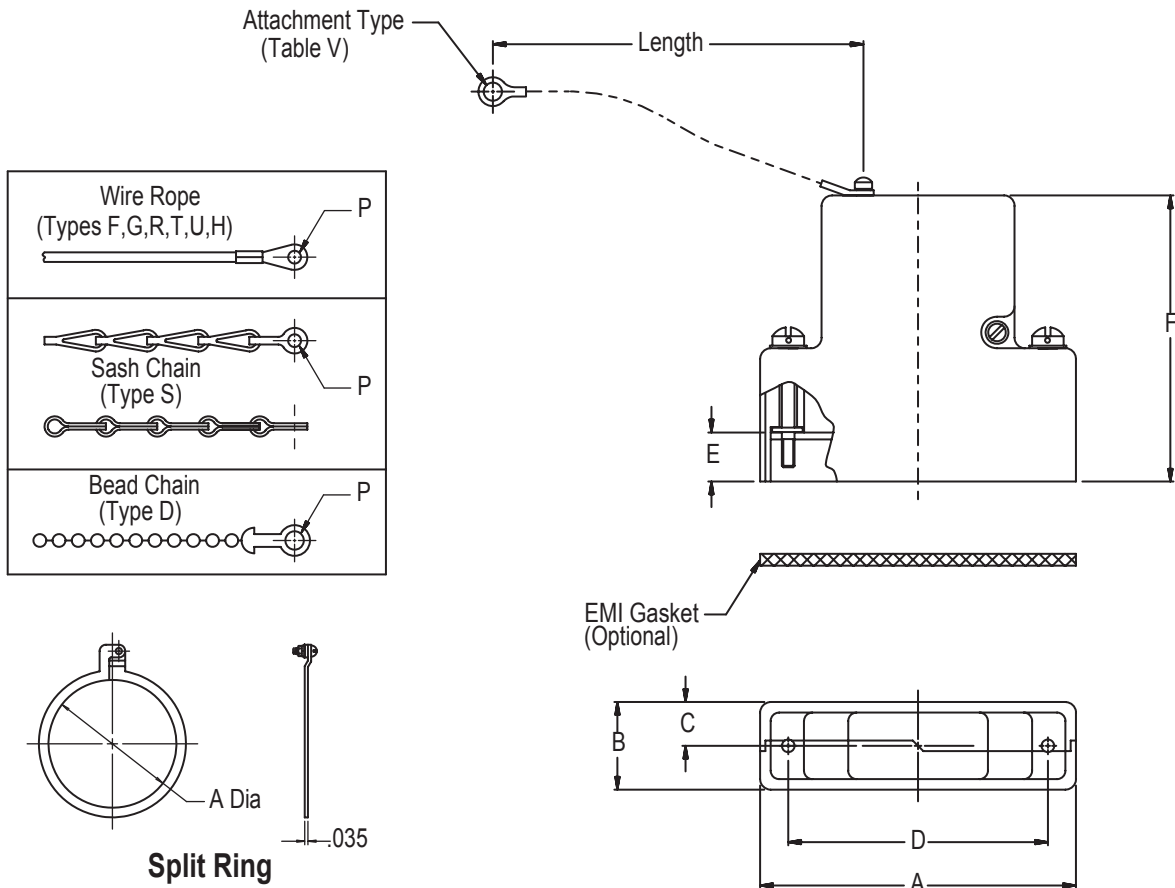

550-200 D-Subminiature Shorting Cap Split Backshells

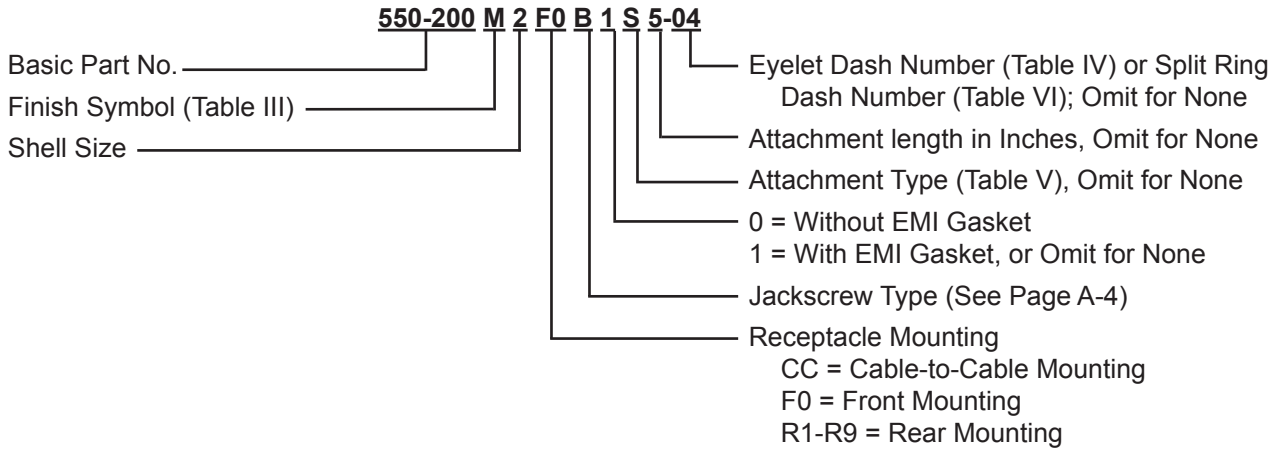

550-200 D-Subminiature Shorting Cap Split Backshells



TABLE I: Common Backshell Dimensions

Dash No.	A Max	B Max	C	D ± .005 (0.13)
1	1.393 (35.4)	.624 (15.8)	.322 (8.2)	.984 (25.0)
2	1.706 (43.4)	.624 (15.8)	.322 (8.2)	1.312 (33.3)
3	2.265 (57.5)	.624 (15.8)	.322 (8.2)	1.852 (47.0)
4	2.900 (73.7)	.624 (15.8)	.322 (8.2)	2.500 (63.5)
5	2.800 (71.1)	.735 (18.7)	.375 (9.5)	2.406 (61.1)
6	2.900 (73.7)	.844 (21.4)	.422 (10.7)	2.500 (63.5)

TABLE II: Cable Mounting Dimensions

Dash No.	Panel Thickness	E	F		
			Sizes 1 & 2	Sizes 3 to 5	Size 6
CC	N/A	.174 (4.4)	1.451 (36.9)	1.671 (42.4)	1.820 (46.2)
F0	N/A	.343 (8.7)	1.625 (41.3)	1.844 (46.8)	2.000 (50.8)
R1	.031 (0.8)	.247 (6.3)	1.525 (38.7)	1.745 (44.3)	1.890 (48.0)
R2	.047 (1.2)	.231 (5.9)	1.509 (38.3)	1.728 (43.9)	1.875 (47.6)
R3	.062 (1.6)	.216 (5.5)	1.500 (38.1)	1.720 (43.7)	1.860 (47.2)
R4	.093 (2.4)	.185 (4.7)	1.470 (37.3)	1.690 (42.9)	1.829 (46.5)
R5	.104 (2.6)	.174 (4.4)	1.451 (36.9)	1.671 (42.4)	1.820 (46.2)
R6	.125 (3.2)	.153 (3.9)	1.430 (36.3)	1.650 (41.9)	1.798 (45.7)
R7	.156 (4.0)	.125 (3.2)	1.400 (35.6)	1.620 (41.1)	1.767 (44.9)
R8	.135 (3.4)	.140 (3.6)	1.417 (36.0)	2.637 (41.6)	1.805 (45.8)
R9	.188 (4.8)	.094 (2.4)	1.368 (34.7)	2.590 (40.4)	1.740 (44.2)

TABLE III: Finishes

Symbol	Description
A	Cadmium Plate/Bright Dip
B	Cadmium Plate/Olive Drab
J	Gold Iridite over Cadmium Plate over Nickel
M	Electroless Nickel
N	Cadmium Plate/Olive Drab over Nickel
NF	Cadmium/Olive Drab over Electroless Nickel (1,000 Hr. Salt Spray)
T	Cadmium Plate/Bright Dip over Nickel
Y	Gold Iridite over Cadmium Plate

TABLE IV: Attachment Diameter P

Dash No.	P Dia ± .010 (0.25)
01	.140 (3.6)
02	.182 (4.6)
03	.191 (4.9)
04	.197 (5.0)
05	.167 (4.2)
06	.125 (3.2)
07	.218 (5.5)
09	.156 (4.0)
00	No Eyelet

TABLE V: Attachment Options

Symbol	Description
D	Bead Chain, CRES, Passivated
F	Wire Rope, Nylon Jacket
G	Nylon Rope
H	Wire Rope, Teflon Jacket
R	Wire Rope, PVC Jacket
T	Wire Rope, No Jacket
S	#8 Sash Chain, CRES, Passivated
U	Wire Rope, Polyurethane Jacket

TABLE VI: Split Ring Diameter and Maximum Mandrel Diameter

Dash No.	A Dia	Max Mandrel Dia (See Note 3)
50	.425 (10.8)	.410 (10.4)
52	.485 (12.3)	.470 (11.9)
54	.640 (16.3)	.625 (15.9)
56	.750 (19.1)	.735 (18.7)
58	.890 (22.6)	.875 (22.2)
60	1.015 (25.8)	1.000 (25.4)
62	1.095 (27.8)	1.080 (27.4)
64	1.130 (28.7)	1.115 (28.3)
66	1.250 (31.8)	1.235 (31.4)
68	1.350 (34.3)	1.335 (33.9)
70	1.375 (34.9)	1.360 (34.5)
72	1.485 (37.7)	1.470 (37.3)
74	1.625 (41.3)	1.610 (40.9)
76	1.750 (44.5)	1.735 (44.1)
78	1.875 (47.6)	1.860 (47.2)
80	1.980 (50.3)	1.965 (49.9)
82	2.060 (52.3)	2.045 (51.9)
84	2.235 (56.8)	2.220 (56.4)
86	2.310 (58.7)	2.295 (58.3)
88	2.475 (62.9)	2.460 (62.5)
90	2.655 (67.4)	2.640 (67.1)
92	2.810 (71.4)	2.795 (71.0)
94	3.045 (77.3)	3.030 (77.0)

1. Metric dimensions (mm) are indicated in parentheses.
2. **DO NOT USE CONNECTORS WITH FLOAT MOUNTINGS.**
3. Maximum recommended diameter of Mandrel over which assembled ring will rotate freely.

Standard Materials and Finishes



The following are Glenair's standard finishes. Individual product pages within this catalog list their most common finishes. Additional finishes are listed within the table below.

TABLE II - STANDARD FINISHES

GLENAIR M85049 SYMBOL		FINISH	SPECIFICATION(S)
SYMBOL	REFERENCE ONLY		
B		Cadmium Plate, Olive Drab	AMS-QQ-P-416, Type II, Class 3
C*	A	Anodize, Black	AMS-A-8625, Type II, Class 2
G*		Hard Coat, Anodic	AMS-A-8625, Type III, Class 1
J		Iridite, Gold Over Cadmium Plate Over Electroless Nickel	MIL-C-5541, Class 3 AMS-QQ-P-416, Type II, Class 3 over AMS-C-26074, Class 3 or 4, Grade B
LF		Cadmium Plate, Bright Over Electroless Nickel	1000 Hour Corrosion Resistance
M	N	Electroless Nickel	AMS-C-26074, Class 4, Grade B; & ASTM B733-90, SC2, Type 1, Class 4
N		Cadmium Plate, Olive Drab Over Electroless Nickel	AMS-QQ-P-416, Type II, Class 3 over Electroless Nickel AMS-C-26074
NC		Zinc Cobalt, Dark Olive Drab	96 Hour Corrosion Resistance
NF	W	Cadmium Plate, Olive Drab Over Electroless Nickel	1000 Hour Corrosion Resistance
T		Cadmium Plate, Bright Over Electroless Nickel	AMS-QQ-P-416, Type II, Class 3 over Electroless Nickel, AMS-C-26074, Class 3 or 4, Grade B
U**		Cadmium Plate, Black	AMS-QQ-P-416, Type II, Class 3
ZN		Zinc-Nickel Alloy, Olive Drab	ASTMB 841-91, Over Electroless Nickel 1000 Hour Salt Spray

* Anodize finish; not suitable for EMI Shielding or grounding applications.
** Applicable to corrosion resisting steel backshells and accessories. Consult factory for other available finishes.

STANDARD MATERIALS - BACKSHELLS AND ACCESSORIES

COMPONENT	MATERIAL	SPECIFICATION
Machined components: such as backshell bodies, fabricated elbows, protective covers, rotatable couplers, dummy stowage receptacles, lock nuts, G-spring support rings, EMI ground rings, grommet followers, etc.	Aluminum	AMS-QQ-A-200 ASTMB221, 209
Die cast components: such as angular backshells, strain relief backshells, strain relief bodies, strain relief saddles, special EMI ground rings, etc.	Aluminum	QQ-A-591 ASTMB85, 26
Backshells or strain reliefs: available in optional corrosion resisting steel; and hardware: such as screws, washers, rivets, wire rope, sash chain, band straps, etc.	Corrosion Resisting Steel	ASTMA582 (300 Series) AMS-QQ-S-763
Elastomeric seals: such as O-rings, cable jacket seals, grommets, etc.	Silicone	ZZ-R-765, MIL-R-25988
Anti-friction and thrust washers	Teflon	TFE
Anti-rotation device	Corrosion Resistant Material	N/A

NOTES

Unless otherwise specified, the following dimensional tolerances will apply:

- .xx = ± .03 (0.8)
- .xxx = ± .015 (0.4)
- Lengths = ± .060 (1.52)
- Angles = ± 5°

Metric dimensions (mm) are indicated in parentheses

D-Subminiature Backshells Jackscrew Options

JACKSCREW - STYLE E (END ENTRY)

Type J Knurled Slotted Head

All jackscrews have 4-40 UNC-2A threads to mate with M24308/26 female screwlocks or 559-001 mounting kits. Not applicable for cable-to-cable applications.

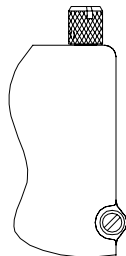

MALE JACKSCREW OPTIONS

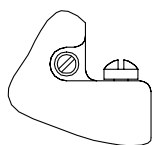

Type B
Fillister Head

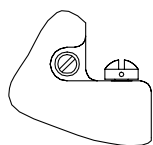

Type D
Drilled
Fillister Head

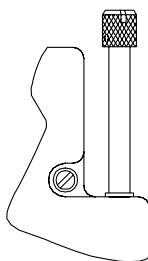

Type E *
Extended Knurled
Slotted Head

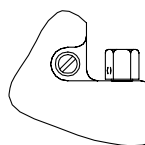

Type H
Hex Head

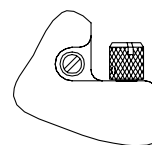

Type K *
Knurled Slotted
Head

Unless otherwise noted, all jackscrews have 4-40 UNC-2A threads to mate with M24308/26 female screwlocks or 559-001 mounting kits. Not applicable for cable-to-cable applications.

* Not available for Style "E" (end entry backshells).

POLARIZING JACKSCREW OPTIONS

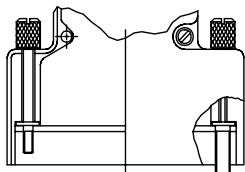

Type F
Turnable Male & Female

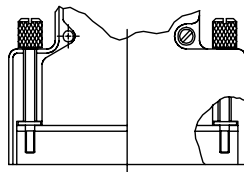

Type M
Turnable Males

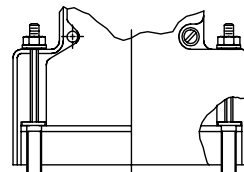

Type P
Fixed Females

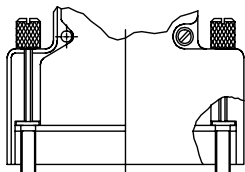

Type L
Turnable Females

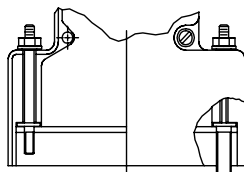

Type N
Fixed Male & Female

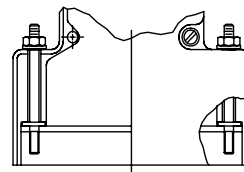

Type R
Fixed Males

X-ON Electronics

Largest Supplier of Electrical and Electronic Components

Click to view similar products for [D-Sub Backshells](#) category:

Click to view products by [Glenair](#) manufacturer:

Other Similar products are found below :

[600X51137X](#) [600X54009X](#) [66241-12A](#) [M85049/6-38N](#) [M85049/86-12N03](#) [M85049/90-13P03](#) [70.350.0636.4](#) [70.350.2435.1](#) [72.350.1035.2](#)
[72.352.2435.1](#) [73.359.4035.3](#) [829472-1](#) [PCS-E20W](#) [970-015-040R011](#) [971-009-030R121](#) [971-009-040R011](#) [971-015-040R011](#) [DPH-B-003](#)
[1437013-9](#) [1484402-8](#) [156-3025-EX](#) [16-500800](#) [165X02659X](#) [165X03399A](#) [165X10259X](#) [165X11359X](#) [165X11689X](#) [165X11759X](#)
[165X11889X](#) [165X11899X](#) [165X13019X](#) [165X13029X](#) [165X13169X](#) [165X13199X](#) [165X13239X](#) [165X13389X](#) [165X13489X](#)
[165X14219X](#) [165X14429X](#) [165X14449X](#) [165X17409X](#) [165X17439X](#) [165X17569X](#) [165X17599X](#) [165X17609X](#) [165X17979X](#) [L171373](#)
[971-025-030R121](#) [300X10989X](#) [165X02609X](#)