

**MIL-C-38999
Series II**

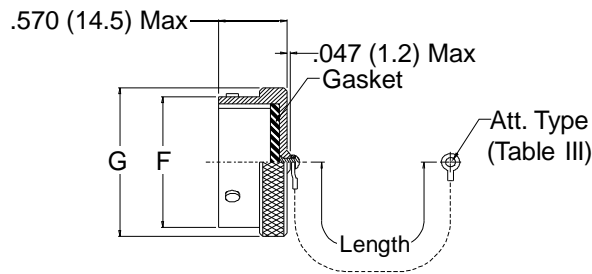

660-014 Plug Cover

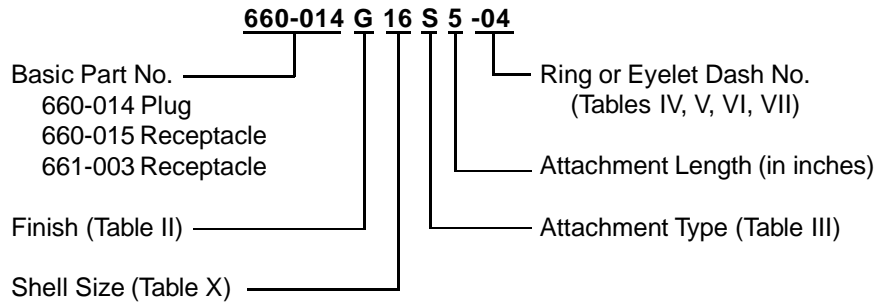
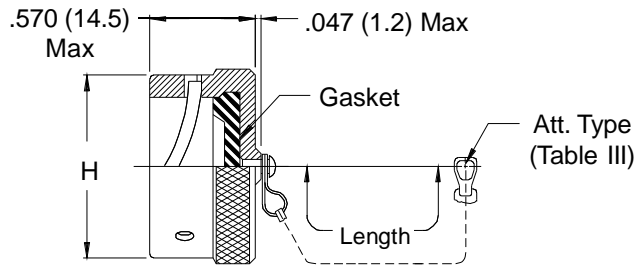

660-015 Receptacle Cover

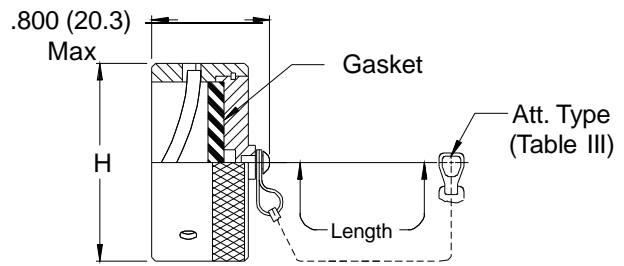

661-003 EMI/RFI Receptacle Cover

TABLE X: SHELL SIZE DIMENSIONS

Shell Size	F Dia	G Dia Max	H Dia Max
08	.473 (12.0)	.720 (18.3)	.719 (18.3)
10	.590 (15.0)	.850 (21.6)	.812 (20.6)
12	.750 (19.1)	1.000 (25.4)	1.000 (25.4)
14	.875 (22.2)	1.130 (28.7)	1.125 (28.6)
16	1.000 (25.4)	1.250 (31.8)	1.250 (31.8)
18	1.125 (28.6)	1.380 (35.1)	1.375 (34.9)
20	1.250 (31.8)	1.500 (38.1)	1.500 (38.1)
22	1.375 (34.9)	1.630 (41.4)	1.625 (41.3)
24	1.500 (38.1)	1.750 (44.5)	1.750 (44.5)

See inside back cover fold-out or page 14 for Table II.

Metric dimensions (mm) are indicated in parentheses.

**660-014 (Plug) - 660-015 (Receptacle)
661-003 (EMI Receptacle)
Protective Covers
MIL-C-38999 Series II**



66 & 78

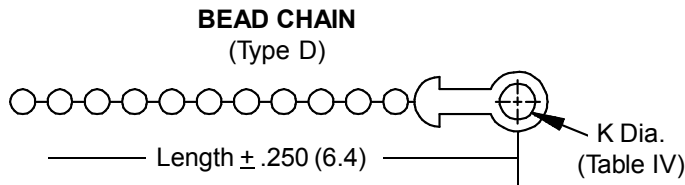
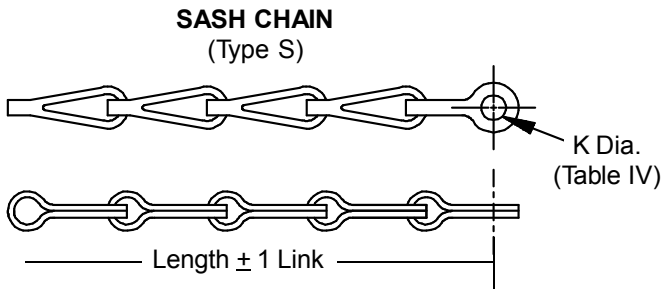
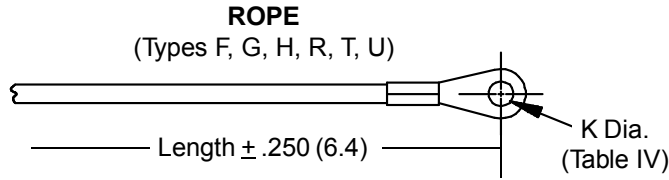

TABLE III: ATTACHMENT

Sym	Attachment Type
D	Bead Chain, Cres., Passivate
F	Wire Rope, Nylon Jacket
G	Nylon Rope
H	Wire Rope, Fluoropolymer Jacket
N	No Attachment
R	Wire Rope, PVC Jacket
S	#8 Sash Chain, Cres., Passivate
T	Wire Rope, No Jacket
U	Wire Rope, Polyurethane Jacket with Terminal

TABLE IV: EYELET

Dash No.	K DIA
01	.140 (3.6)
02	.182 (4.6)
03	.191 (4.9)
04	.197 (5.0)
05	.167 (4.2)
06	.125 (3.2)
07	.218 (5.5)
09	.156 (4.0)
00	No Eyelet

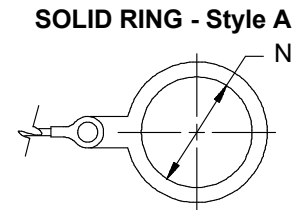
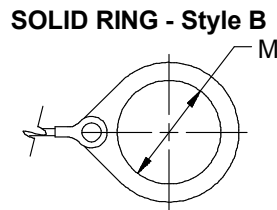
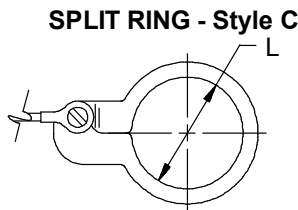

TABLE V: SPLIT RING STYLE C

Dash No.	L Dia. ±.015 (0.4)	Dash No.	L Dia. ±.015 (0.4)
50	.425 (10.8)	74	1.625 (41.3)
52	.485 (12.3)	76	1.750 (44.5)
54	.640 (16.3)	78	1.875 (47.6)
56	.750 (19.1)	80	1.980 (50.3)
58	.890 (22.6)	82	2.060 (52.3)
60	1.015 (25.8)	84	2.235 (56.8)
62	1.095 (27.8)	86	2.310 (58.7)
64	1.130 (28.7)	88	2.475 (62.9)
66	1.250 (31.8)	90	2.655 (67.4)
68	1.350 (34.3)	92	2.810 (71.4)
70	1.390 (35.3)	94	3.045 (77.3)
72	1.485 (37.7)		

TABLE VI: SOLID RING STYLE B

Dash No.	M Dia. ±.015 (0.4)	Dash No.	M Dia. ±.015 (0.4)
08	.468 (11.9)	24	1.484 (37.7)
10	.593 (15.1)	25	1.577 (40.1)
12	.718 (18.2)	27	1.640 (41.7)
13	.765 (19.4)	28	1.687 (42.8)
14	.844 (21.4)	29	1.765 (44.8)
15	.890 (22.6)	30	1.890 (48.0)
16	.968 (24.6)	31	1.953 (49.6)
17	1.015 (25.8)	32	1.968 (50.0)
18	1.093 (27.8)	33	2.077 (52.8)
19	1.140 (29.0)	35	2.140 (54.4)
20	1.203 (30.6)	36	2.187 (55.5)
21	1.265 (32.1)	40	2.406 (61.1)
22	1.343 (34.1)	44	2.656 (67.5)
23	1.453 (36.9)	48	3.031 (77.0)
		118	.310 (7.9)

TABLE VII: SOLID RING STYLE A

Dash No.	N Dia. ±.015 (0.4)	Dash No.	N Dia. ±.015 (0.4)
095	.312 (7.9)	109	1.266 (32.2)
100	.391 (9.9)	209	1.312 (33.3)
101	.516 (13.1)	110	1.391 (35.3)
102	.583 (14.8)	210	1.438 (36.5)
103	.641 (16.3)	111	1.521 (38.6)
104	.708 (18.0)	211	1.536 (39.0)
105	.766 (19.5)	112	1.641 (41.7)
205	.788 (20.0)	113	1.766 (44.9)
106	.896 (22.2)	213	1.812 (46.0)
206	.907 (23.0)	114	1.891 (48.0)
107	1.016 (25.8)	214	1.938 (49.2)
207	1.025 (26.0)	115	2.078 (52.8)
108	1.141 (29.0)	116	2.406 (61.1)
308	1.188 (30.2)	117	2.510 (63.8)
208	1.203 (30.6)		

X-ON Electronics

Largest Supplier of Electrical and Electronic Components

Click to view similar products for [Circular MIL Spec Tools, Hardware & Accessories](#) *category:*

Click to view products by [Glenair](#) *manufacturer:*

Other Similar products are found below :

[0113-201-2025](#) [600-079-06](#) [600-146-06](#) [M10-101982-143](#) [M10-101982-163](#) [M10-101983-183](#) [M10-150912-083](#) [M10-454396-008](#)
[602GB18808](#) [CS3102A-22-14PW](#) [M2887615-CD](#) [627-009](#) [M38999/9-19B](#) [630A007NF083A](#) [630B007M051A](#) [630BJ003NF032H](#) [637-](#)
[149NF04B](#) [M39029/29-215](#) [6408-203V-09273](#) [6426-201-11343](#) [650FS002NF16](#) [660-008NF14S7-01](#) [660-009M22H8-03](#) [660-013NF19U6-](#)
[210](#) [660-015M10S6-17](#) [660-015NF10S5-01](#) [660-015NF14R3.5-01](#) [660-023NF19H6-19](#) [660-024NF11S12-01](#) [660-024NF11S3-01](#) [660-](#)
[024NF17S4-109](#) [660-050XM17F4-01](#) [660-068NF25R6-30G](#) [660-070M23S8-04](#) [660-073MTCH9-20](#) [M83723/61-18W](#) [M83723/61-218R](#)
[M83723/61-224W](#) [667-084-23C](#) [667-084-35C](#) [667-224NF16](#) [687-697NF-1](#) [M85049/94-10-A](#) [M85049/96-7-A](#) [M855282-10A01A](#)
[M85528/2-10B](#) [M855282-18A01A](#) [M85528/2-22A01A](#) [M85528/2-22AA](#) [710HS460NF2508](#)