

MIL-C-81511

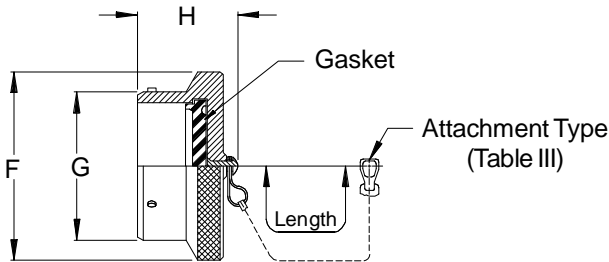

**660-016 Plug Cover - Series 1 & 3  
 (100% Scoop Proof)**  
**660-017 Plug Cover - Series 2 & 4  
 (50% Scoop Proof)**

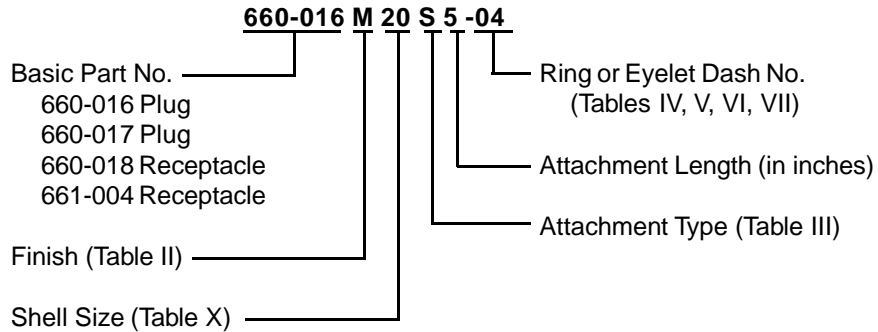
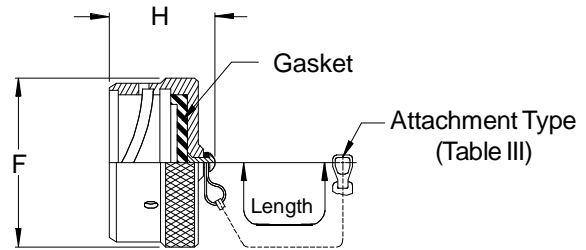

**660-018 Receptacle Cover**

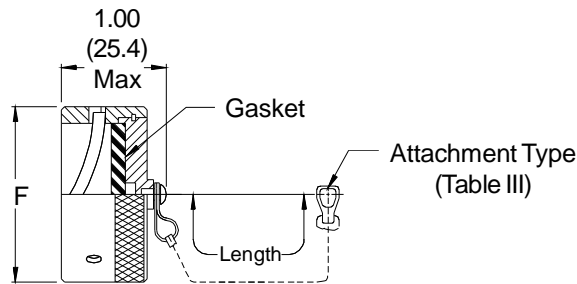

**661-004 EMI/RFI Receptacle Cover**

**TABLE X: SHELL SIZE DIMENSIONS**

Shell Size	F Dia		G Dia		H Max	
	Max		Max		Series I & III	Series II & IV
08	.845	(21.5)	.553	(14.0)	1.125 (28.6)	.985 (25.0)
10	.970	(24.6)	.678	(17.2)	1.125 (28.6)	.985 (25.0)
14	1.220	(31.0)	.928	(23.6)	1.125 (28.6)	.985 (25.0)
16	1.345	(34.2)	1.054	(26.8)	1.125 (28.6)	.985 (25.0)
18	1.470	(37.3)	1.178	(29.9)	1.125 (28.6)	.985 (25.0)
20	1.595	(40.5)	1.303	(33.1)	1.125 (28.6)	
22	1.720	(43.7)	1.428	(36.3)	1.125 (28.6)	
24	1.845	(46.9)	1.553	(39.4)	1.125 (28.6)	

See inside back cover fold-out or page 14 for Table II.

Metric dimensions (mm) are indicated in parentheses.

**660-016 (Plug) - 660-017 (Plug)**  
**660-018 (Receptacle) - 661-004 (EMI Receptacle)**  
**Protective Covers**  
**MIL-C-81511**



**66 & 78**

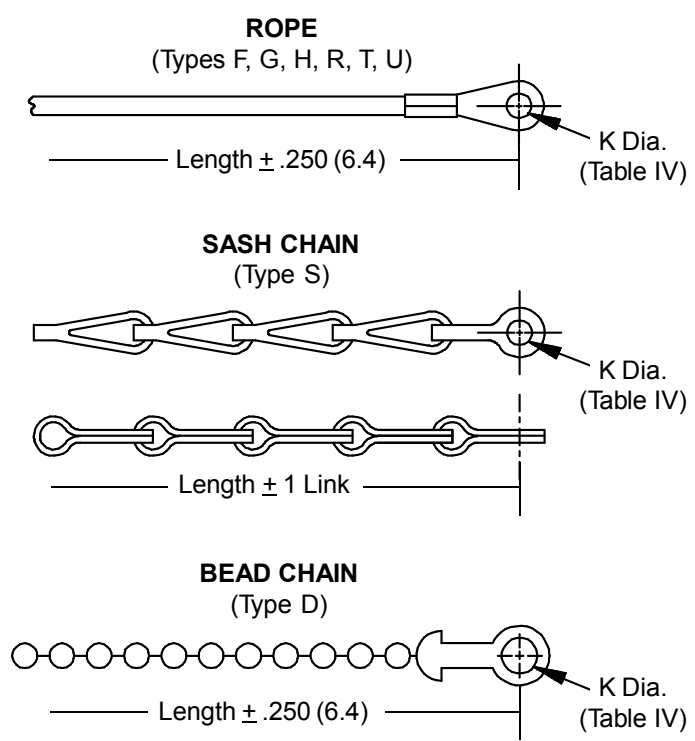
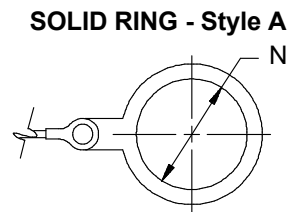
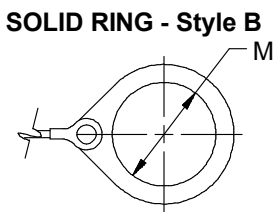
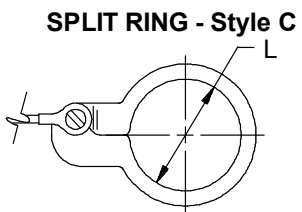

**TABLE III: ATTACHMENT**

Sym	Attachment Type
D	Bead Chain, Cres., Passivate
F	Wire Rope, Nylon Jacket
G	Nylon Rope
H	Wire Rope, Fluoropolymer Jacket
N	No Attachment
R	Wire Rope, PVC Jacket
S	#8 Sash Chain, Cres., Passivate
T	Wire Rope, No Jacket
U	Wire Rope, Polyurethane Jacket with Terminal

**TABLE IV: EYELET**

Dash No.	K DIA
01	.140 (3.6)
02	.182 (4.6)
03	.191 (4.9)
04	.197 (5.0)
05	.167 (4.2)
06	.125 (3.2)
07	.218 (5.5)
09	.156 (4.0)
00	No Eyelet



**TABLE V: SPLIT RING STYLE C**

Dash No.	L Dia. $\pm$ .015 (0.4)	Dash No.	L Dia. $\pm$ .015 (0.4)
50	.425 (10.8)	74	1.625 (41.3)
52	.485 (12.3)	76	1.750 (44.5)
54	.640 (16.3)	78	1.875 (47.6)
56	.750 (19.1)	80	1.980 (50.3)
58	.890 (22.6)	82	2.060 (52.3)
60	1.015 (25.8)	84	2.235 (56.8)
62	1.095 (27.8)	86	2.310 (58.7)
64	1.130 (28.7)	88	2.475 (62.9)
66	1.250 (31.8)	90	2.655 (67.4)
68	1.350 (34.3)	92	2.810 (71.4)
70	1.390 (35.3)	94	3.045 (77.3)
72	1.485 (37.7)		

**TABLE VI: SOLID RING STYLE B**

Dash No.	M Dia. $\pm$ .015 (0.4)	Dash No.	M Dia. $\pm$ .015 (0.4)
08	.468 (11.9)	24	1.484 (37.7)
10	.593 (15.1)	25	1.577 (40.1)
12	.718 (18.2)	27	1.640 (41.7)
13	.765 (19.4)	28	1.687 (42.8)
14	.844 (21.4)	29	1.765 (44.8)
15	.890 (22.6)	30	1.890 (48.0)
16	.968 (24.6)	31	1.953 (49.6)
17	1.015 (25.8)	32	1.968 (50.0)
18	1.093 (27.8)	33	2.077 (52.8)
19	1.140 (29.0)	35	2.140 (54.4)
20	1.203 (30.6)	36	2.187 (55.5)
21	1.265 (32.1)	40	2.406 (61.1)
22	1.343 (34.1)	44	2.656 (67.5)
23	1.453 (36.9)	48	3.031 (77.0)
		118	.310 (7.9)

**TABLE VII: SOLID RING STYLE A**

Dash No.	N Dia. $\pm$ .015 (0.4)	Dash No.	N Dia. $\pm$ .015 (0.4)
095	.312 (7.9)	109	1.266 (32.2)
100	.391 (9.9)	209	1.312 (33.3)
101	.516 (13.1)	110	1.391 (35.3)
102	.583 (14.8)	210	1.438 (36.5)
103	.641 (16.3)	111	1.521 (38.6)
104	.708 (18.0)	211	1.536 (39.0)
105	.766 (19.5)	112	1.641 (41.7)
205	.788 (20.0)	113	1.766 (44.9)
106	.896 (22.2)	213	1.812 (46.0)
206	.907 (23.0)	114	1.891 (48.0)
107	1.016 (25.8)	214	1.938 (49.2)
207	1.025 (26.0)	115	2.078 (52.8)
108	1.141 (29.0)	116	2.406 (61.1)
308	1.188 (30.2)	117	2.510 (63.8)
208	1.203 (30.6)		

## X-ON Electronics

Largest Supplier of Electrical and Electronic Components

*Click to view similar products for* [Circular MIL Spec Tools, Hardware & Accessories](#) *category:*

*Click to view products by* [Glenair](#) *manufacturer:*

Other Similar products are found below :

[0113-201-2025](#) [600-079-06](#) [600-146-06](#) [M10-101982-143](#) [M10-101982-163](#) [M10-101983-183](#) [M10-150912-083](#) [M10-454396-008](#)  
[602GB18808](#) [CS3102A-22-14PW](#) [M2887615-CD](#) [627-009](#) [M38999/9-19B](#) [630A007NF083A](#) [630B007M051A](#) [630BJ003NF032H](#) [637-](#)  
[149NF04B](#) [M39029/29-215](#) [6408-203V-09273](#) [6426-201-11343](#) [650FS002NF16](#) [660-008NF14S7-01](#) [660-009M22H8-03](#) [660-013NF19U6-](#)  
[210](#) [660-015M10S6-17](#) [660-015NF10S5-01](#) [660-015NF14R3.5-01](#) [660-023NF19H6-19](#) [660-024NF11S12-01](#) [660-024NF11S3-01](#) [660-](#)  
[024NF17S4-109](#) [660-050XM17F4-01](#) [660-068NF25R6-30G](#) [660-070M23S8-04](#) [660-073MTCH9-20](#) [M83723/61-18W](#) [M83723/61-218R](#)  
[M83723/61-224W](#) [667-084-23C](#) [667-084-35C](#) [667-224NF16](#) [687-697NF-1](#) [M85049/94-10-A](#) [M85049/96-7-A](#) [M855282-10A01A](#)  
[M85528/2-10B](#) [M855282-18A01A](#) [M85528/2-22A01A](#) [M85528/2-22AA](#) [710HS460NF2508](#)