

**MIL-C-38999  
Series III**

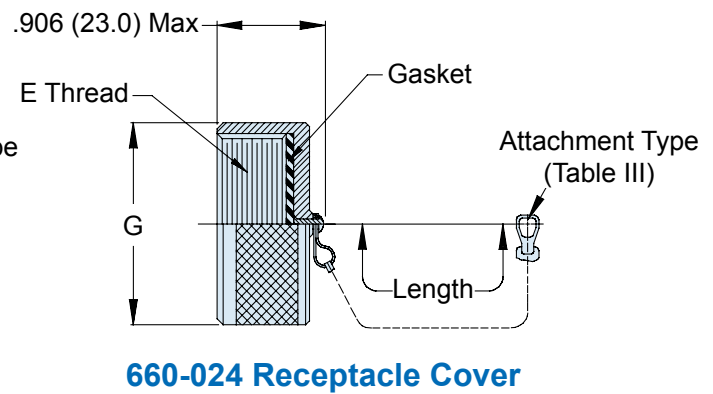
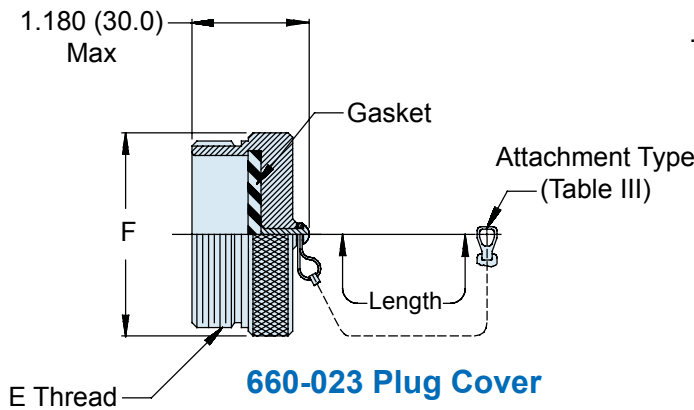
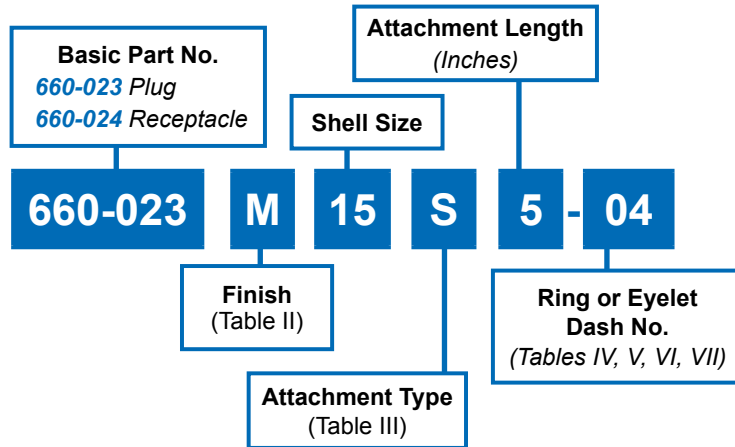

SHELL SIZE DIMENSIONS				
Shell Size	Shell Size Code Ref.	E Thread	F Max	G Max
09	A	.6250-0.1P-0.3L-TS	.906 (23.0)	.906 (23.0)
11	B	.7500-0.1P-0.3L-TS	1.024 (26.0)	1.102 (28.0)
13	C	.8750-0.1P-0.3L-TS	1.220 (31.0)	1.220 (31.0)
15	D	1.0000-0.1P-0.3L-TS	1.300 (33.0)	1.260 (32.0)
17	E	1.1875-0.1P-0.3L-TS	1.457 (37.0)	1.457 (37.0)
19	F	1.2500-0.1P-0.3L-TS	1.575 (40.0)	1.535 (39.0)
21	G	1.3750-0.1P-0.3L-TS	1.732 (44.0)	1.654 (42.0)
23	H	1.5000-0.1P-0.3L-TS	1.811 (46.0)	1.772 (45.0)
25	J	1.6250-0.1P-0.3L-TS	1.969 (50.0)	1.929 (49.0)

Metric dimensions (mm) are indicated in parentheses.

TABLE II: FINISHES	
Symbol	Finish
B	Cadmium Plate, Olive Drab
C	Anodize, Black
GB	Black Anodize, Hard Coat
M	Electroless Nickel
N	Cad Plate, Olive Drab over Electroless Nickel
NF	Cadmium Plate, Olive Drab over Electroless Nickel
MT	Ni-PTFE 1000 Hour Grey™ Nickel Fluorocarbon Polymer
Z1	Stainless Steel Passivate
ZN	Zinc-Nickel

**660-023 (Plug) - 660-024 (Receptacle)**  
**Protective Covers**  
**MIL-C-38999 Series III Threaded**

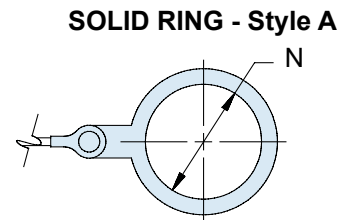
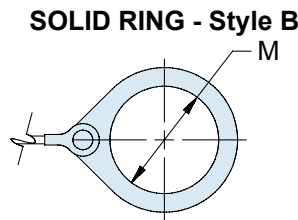
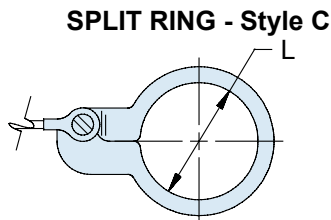
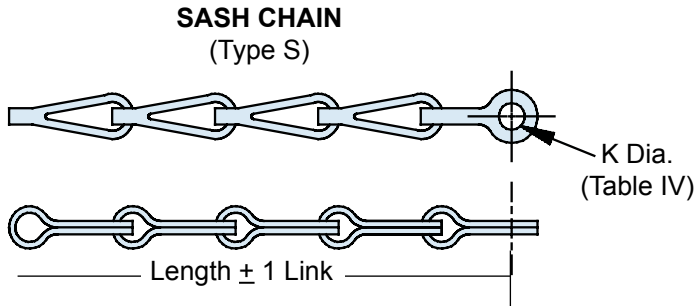
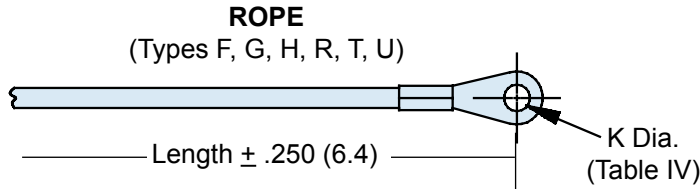

**TABLE III: ATTACHMENTS**

Sym	Attachment Type
D	Bead Chain, Cres, Passivate
F	Wire Rope, Nylon Jacket
G	Nylon Rope
H	Wire Rope, Teflon Jacket
N	No Attachment
R	Wire Rope, PVC Jacket
S	#8 Sash Chain, Cres, Passivate
T	Wire Rope, No Jacket
U	Wire Rope, Polyurethane Jacket with Terminal

**TABLE IV: EYELET**

Dash No.	K Dia ±.010 (0.3)
01	.140 (3.6)
02	.182 (4.6)
03	.191 (4.9)
04	.197 (5.0)
05	.167 (4.2)
06	.125 (3.2)
07	.218 (5.5)
09	.156 (4.0)
00	No Eyelet

**TABLE V: STYLE C RING DIA.**

Dash No.	N Dia ±.015 (0.4)	Dash No.	N Dia ±.015 (0.4)
50	.425 (10.8)	74	1.625 (41.3)
52	.485 (12.3)	76	1.750 (44.5)
54	.640 (16.3)	78	1.875 (47.6)
56	.750 (19.1)	80	1.980 (50.3)
58	.890 (22.6)	82	2.060 (52.3)
60	1.015 (25.8)	84	2.235 (56.8)
62	1.095 (27.8)	86	2.310 (58.7)
64	1.130 (28.7)	88	2.475 (62.9)
66	1.250 (31.8)	90	2.655 (67.4)
68	1.350 (34.3)	92	2.810 (71.4)
70	1.390 (35.3)	94	3.045 (77.3)
72	1.485 (37.7)		

**TABLE VI: STYLE B RING DIA.**

Dash No.	N Dia ±.015 (0.4)	Dash No.	N Dia ±.015 (0.4)
08	.468 (11.9)	24	1.484 (37.7)
10	.593 (15.1)	25	1.577 (40.1)
12	.718 (18.2)	27	1.640 (41.7)
13	.765 (19.4)	28	1.687 (42.8)
14	.844 (21.4)	29	1.765 (44.8)
15	.890 (22.6)	30	1.890 (48.0)
16	.968 (24.6)	31	1.953 (49.6)
17	1.015 (25.8)	32	1.968 (50.0)
18	1.093 (27.8)	33	2.077 (52.8)
19	1.140 (29.0)	35	2.140 (54.4)
20	1.203 (30.6)	36	2.187 (55.5)
21	1.265 (32.1)	40	2.406 (61.1)
22	1.343 (34.1)	44	2.656 (67.5)
23	1.453 (36.9)	48	3.031 (77.0)
		118	.310 (7.9)

**TABLE VII: STYLE A RING DIA.**

Dash No.	N Dia ±.015 (0.4)	Dash No.	N Dia ±.015 (0.4)
095	.312 (7.9)	109	1.266 (32.2)
100	.391 (9.9)	209	1.312 (33.3)
101	101.516 (13.1)	110	1.391 (35.3)
102	102.583 (14.8)	210	1.438 (36.5)
103	103.641 (16.3)	111	1.521 (38.6)
104	104.708 (18.0)	211	1.536 (39.0)
105	105.766 (19.5)	112	1.641 (41.7)
205	205.788 (20.0)	113	1.766 (44.9)
106	106.896 (22.2)	213	1.812 (46.0)
206	206.907 (23.0)	114	1.891 (48.0)
107	1071.016 (25.8)	214	1.938 (49.2)
207	2071.025 (26.0)	115	2.078 (52.8)
108	1081.141 (29.0)	116	2.406 (61.1)
308	3081.188 (30.2)	117	2.510 (63.8)
208	2081.203 (30.6)		

## X-ON Electronics

Largest Supplier of Electrical and Electronic Components

*Click to view similar products for* [Circular MIL Spec Tools, Hardware & Accessories](#) *category:*

*Click to view products by* [Glenair](#) *manufacturer:*

Other Similar products are found below :

[0113-201-2025](#) [600-079-06](#) [600-146-06](#) [M10-101982-143](#) [M10-101982-163](#) [M10-101983-183](#) [M10-150912-083](#) [M10-454396-008](#)  
[602GB18808](#) [CS3102A-22-14PW](#) [M2887615-CD](#) [627-009](#) [M38999/9-19B](#) [630A007NF083A](#) [630B007M051A](#) [630BJ003NF032H](#) [637-](#)  
[149NF04B](#) [M39029/29-215](#) [6408-203V-09273](#) [6426-201-11343](#) [650FS002NF16](#) [660-008NF14S7-01](#) [660-009M22H8-03](#) [660-013NF19U6-](#)  
[210](#) [660-015M10S6-17](#) [660-015NF10S5-01](#) [660-015NF14R3.5-01](#) [660-023NF19H6-19](#) [660-024NF11S12-01](#) [660-024NF11S3-01](#) [660-](#)  
[024NF17S4-109](#) [660-050XM17F4-01](#) [660-068NF25R6-30G](#) [660-070M23S8-04](#) [660-073MTCH9-20](#) [M83723/61-18W](#) [M83723/61-218R](#)  
[M83723/61-224W](#) [667-084-23C](#) [667-084-35C](#) [667-224NF16](#) [687-697NF-1](#) [M85049/94-10-A](#) [M85049/96-7-A](#) [M855282-10A01A](#)  
[M85528/2-10B](#) [M855282-18A01A](#) [M85528/2-22A01A](#) [M85528/2-22AA](#) [710HS460NF2508](#)