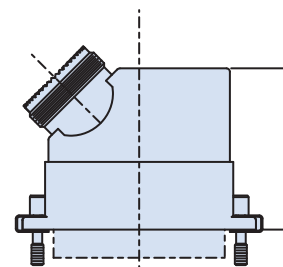
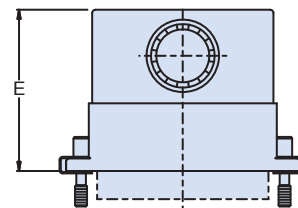
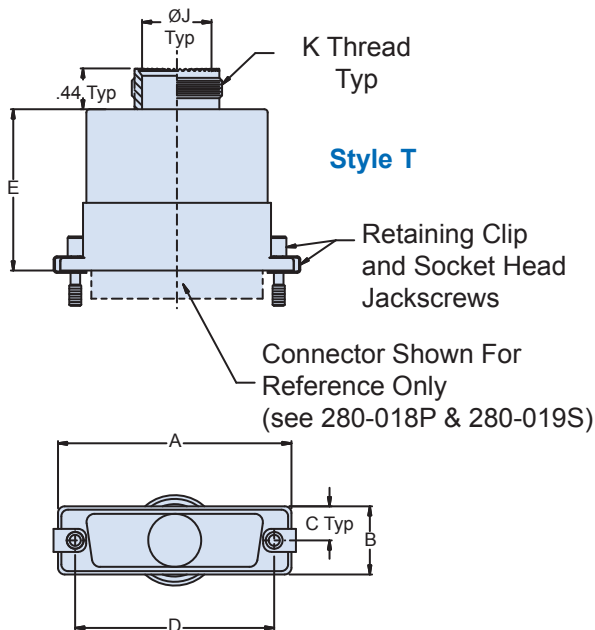
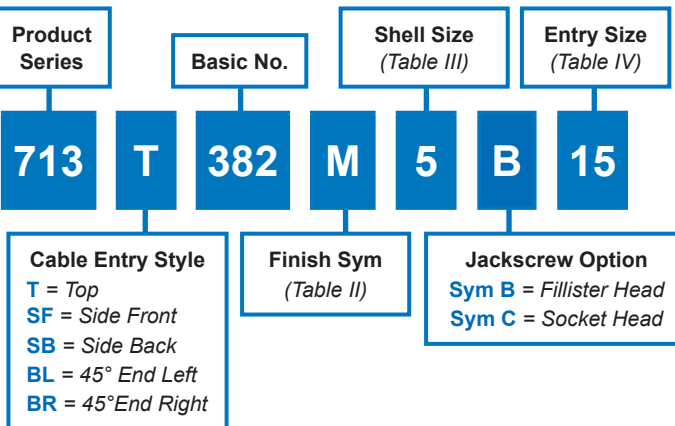

Series 28 HiPer-D connector adapter with MIL-DTL-38999 Series III (H code) accessory thread and interface teeth
How To Order

Material & Finish

- Adapter: See Table II
- Jackscrews, Retaining Clips: Cres/Passivate

Notes

- MIL-DTL-38999, Series III accessory interface (Glenair Code H).
- Entry Size corresponds to MIL-DTL-38999, Series III shell size.

713-382
Series 28 HiPer-D Connector Adapter
 Top, Side or 45° Entry



| Table III | | | | | | | | | | | | | | |
|------------|----------------------|-------|--------|-------|--------|-------|--------|----------|--------|-------|--------|-------|--------|-----------|
| Shell Size | Com'l Shell Size Ref | A Max | | B Max | | C Ref | | D ± .005 | | E Max | | F Max | | Max Entry |
| 1 | E/09 | 1.393 | (35.4) | .624 | (15.8) | .312 | (7.92) | .984 | (25.0) | 1.31 | (33.3) | 1.69 | (42.9) | 13 |
| 2 | A/15 | 1.709 | (43.4) | .624 | (15.8) | .312 | (7.92) | 1.312 | (33.3) | 1.47 | (37.3) | 1.79 | (45.5) | 15 |
| 3 | B/25 | 2.265 | (57.5) | .624 | (15.8) | .312 | (7.92) | 1.852 | (47.0) | 1.59 | (40.4) | 1.87 | (47.5) | 17 |
| 4 | C/37 | 2.900 | (74.0) | .624 | (15.8) | .312 | (7.92) | 2.500 | (63.5) | 1.59 | (40.4) | 1.90 | (48.3) | 17 |
| 5 | D/50 | 2.800 | (71.1) | .750 | (19.1) | .375 | (9.53) | 2.406 | (61.1) | 1.82 | (46.2) | 2.05 | (52.1) | 21 |
| 6 | F/104 | 2.900 | (74.0) | .844 | (21.4) | .422 | (10.7) | 2.500 | (63.5) | 1.82 | (46.2) | 2.06 | (42.3) | 21 |

| Table IV | | | |
|------------|--------------------|--------------|---------------------|
| Entry Size | Conduit Size (Ref) | Ø J | K Thread Iso Metric |
| 09 | 06, 09 | .281 (7.14) | M12 X 1.0-6g |
| 11 | 10, 12 | .397 (10.1) | M15 X 1.0-6g |
| 13 | 14, 16 | .511 (13.0) | M18 X 1.0-6g |
| 15 | 20 | .636 (16.2) | M22 X 1.0-6g |
| 17 | 24 | .761 (19.3) | M25 X 1.0-6g |
| 19 | 28 | .875 (22.2) | M28 X 1.0-6g |
| 21 | 32 | 1.000 (25.4) | M31 X 1.0-6g |

| Table II | | | |
|----------|--|--|--------------------|
| Sym | Material | Finish Description | |
| B | Aluminum | Cadmium Olive Drab | |
| C | | Anodize, Black | |
| M | | Electroless Nickel | |
| MT | | Nickel - PTFE | |
| NF | | Cadmium/Olive Drab over Electroless Nickel | |
| UCR | | Zinc Cobalt/Black | |
| ZN | | Zinc Nickel/Olive Drab over Electroless Nickel | |
| ZNU | | Zinc Nickel/Black over Electroless Nickel | |
| Z1 | | Stainless Steel | Passivate |
| ZM | | | Electroless Nickel |
| ZMT | Nickel - PTFE | | |
| ZW | Cadmium/Olive Drab over Electroless Nickel | | |

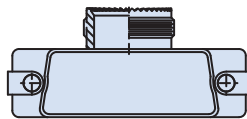

Style SB

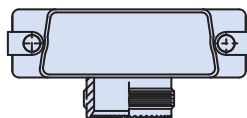

Style SF



Style BR



Style BL

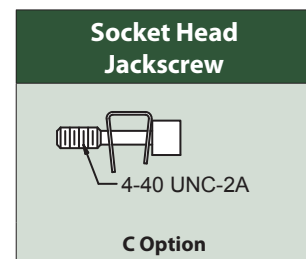

X-ON Electronics

Largest Supplier of Electrical and Electronic Components

Click to view similar products for [Rectangular MIL Spec Connectors](#) category:

Click to view products by [Glenair](#) manufacturer:

Other Similar products are found below :

[891-011-15SA2-BSST](#) [CTS-S16/16](#) [65002-062](#) [CY4602-000](#) [732-8020-01](#) [77058-22-55PN](#) [81542-20](#) [86.030.0053.0](#) [1241346-1](#) [RM252-020-311-2900](#) [DMC-M 08-16 SA](#) [1589051-4](#) [MSO34MPK1E1](#) [BACC65CAMA](#) [BACC65CP1PN](#) [BACI10BC0816PNBA](#) [HSB-D4S03DM222X](#) [2217548-1](#) [891-006-9PS-BST1T](#) [891-009-15SA2-BRT1T](#) [27963-20T12](#) [SIM2S100A](#) [1604996-2](#) [SMD25PN90L-4055](#) [1900ND08S1B00A](#) [22628-10-6P-791](#) [33526M11-08PD](#) [RE04-212S](#) [M32139/03-G05SN](#) [CTD160E01F-6148](#) [CTJ112E03B](#) [CTJ122E02D-8000](#) [CTJ-3D-12](#) [CTJ920E06N-513](#) [CTJ920E12N-513](#) [CTL-16-090](#) [RM300-000-581-0000](#) [CY4600-000](#) [CY4601-000](#) [38111-14-15SN](#) [38112-14-15PN](#) [MMA23-0111R1](#) [MMD25-0071P1](#) [33516062020](#) [33526M11-08PE](#) [DMC-M99-01AN](#) [Y59113WE20PNV00300](#) [ZPF000000000106310](#) [105979-31](#) [EN4165M01AD0G0](#)