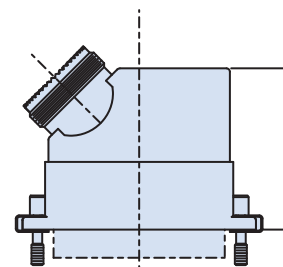
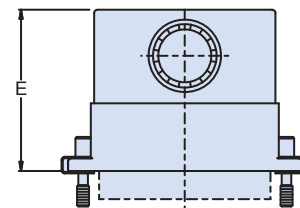
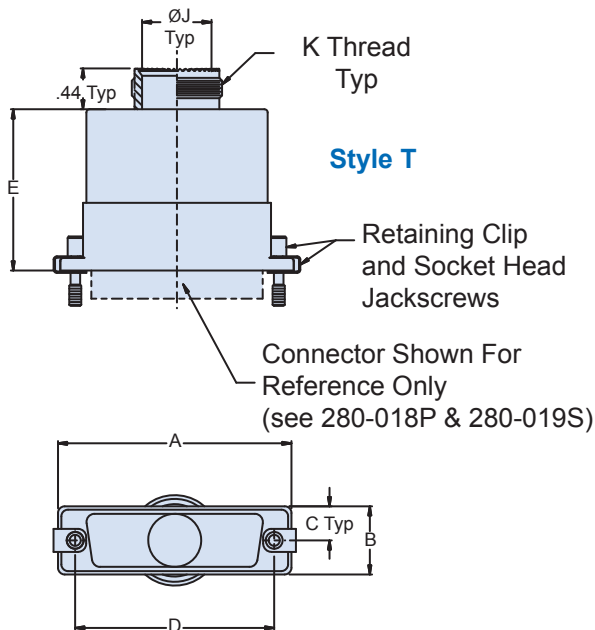
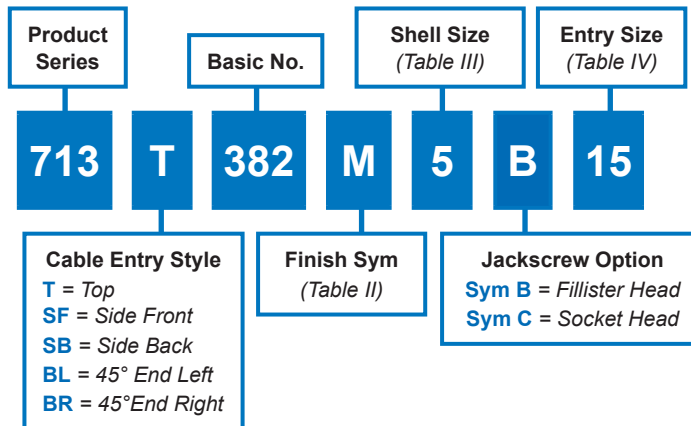

**Series 28 HiPer-D connector adapter with MIL-DTL-38999 Series III (H code) accessory thread and interface teeth**
**How To Order**

**Material & Finish**

- Adapter: See Table II
- Jackscrews, Retaining Clips: Cres/Passivate

**Notes**

- MIL-DTL-38999, Series III accessory interface (Glenair Code H).
- Entry Size corresponds to MIL-DTL-38999, Series III shell size.

713-382  
**Series 28 HiPer-D Connector Adapter**  
 Top, Side or 45° Entry



Table III														
Shell Size	Com'l Shell Size Ref	A Max		B Max		C Ref		D ± .005		E Max		F Max		Max Entry
1	E/09	1.393	(35.4)	.624	(15.8)	.312	(7.92)	.984	(25.0)	1.31	(33.3)	1.69	(42.9)	13
2	A/15	1.709	(43.4)	.624	(15.8)	.312	(7.92)	1.312	(33.3)	1.47	(37.3)	1.79	(45.5)	15
3	B/25	2.265	(57.5)	.624	(15.8)	.312	(7.92)	1.852	(47.0)	1.59	(40.4)	1.87	(47.5)	17
4	C/37	2.900	(74.0)	.624	(15.8)	.312	(7.92)	2.500	(63.5)	1.59	(40.4)	1.90	(48.3)	17
5	D/50	2.800	(71.1)	.750	(19.1)	.375	(9.53)	2.406	(61.1)	1.82	(46.2)	2.05	(52.1)	21
6	F/104	2.900	(74.0)	.844	(21.4)	.422	(10.7)	2.500	(63.5)	1.82	(46.2)	2.06	(42.3)	21

Table IV			
Entry Size	Conduit Size (Ref)	Ø J	K Thread Iso Metric
09	06, 09	.281 (7.14)	M12 X 1.0-6g
11	10, 12	.397 (10.1)	M15 X 1.0-6g
13	14, 16	.511 (13.0)	M18 X 1.0-6g
15	20	.636 (16.2)	M22 X 1.0-6g
17	24	.761 (19.3)	M25 X 1.0-6g
19	28	.875 (22.2)	M28 X 1.0-6g
21	32	1.000 (25.4)	M31 X 1.0-6g

Table II			
Sym	Material	Finish Description	
B	Aluminum	Cadmium Olive Drab	
C		Anodize, Black	
M		Electroless Nickel	
MT		Nickel - PTFE	
NF		Cadmium/Olive Drab over Electroless Nickel	
UCR		Zinc Cobalt/Black	
ZN		Zinc Nickel/Olive Drab over Electroless Nickel	
ZNU		Zinc Nickel/Black over Electroless Nickel	
Z1		Stainless Steel	Passivate
ZM			Electroless Nickel
ZMT	Nickel - PTFE		
ZW	Cadmium/Olive Drab over Electroless Nickel		

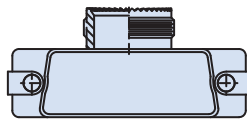

Style SB

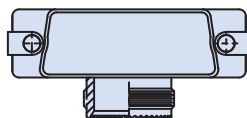

Style SF



Style BR



Style BL

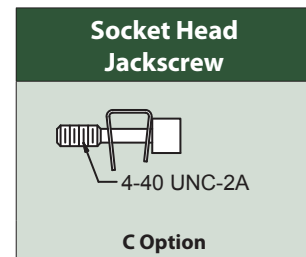

## X-ON Electronics

Largest Supplier of Electrical and Electronic Components

*Click to view similar products for [Rectangular Mil Spec Connectors](#) category:*

*Click to view products by [Glenair](#) manufacturer:*

Other Similar products are found below :

[891-011-15SA2-BSST](#) [CTS-S16/16](#) [65002-062](#) [CY4602-000](#) [732-8020-01](#) [77058-22-55PN](#) [81542-20](#) [86.030.0053.0](#) [1241346-1](#) [RM252-020-311-2900](#) [DMC-M 08-16 SA](#) [1589051-4](#) [MSO34MPK1E1](#) [BACC65CAMA](#) [BACC65CP1PN](#) [BACI10BC0816PNBA](#) [HSB-D4S03DM222X](#) [2217548-1](#) [891-006-9PS-BST1T](#) [891-009-15SA2-BRT1T](#) [27963-20T12](#) [SIM2S100A](#) [1604996-2](#) [SMD25PN90L-4055](#) [1900ND08S1B00A](#) [22628-10-6P-791](#) [33526M11-08PD](#) [RE04-212S](#) [M32139/03-G05SN](#) [CTD160E01F-6148](#) [CTJ112E03B](#) [CTJ122E02D-8000](#) [CTJ-3D-12](#) [CTJ920E06N-513](#) [CTJ920E12N-513](#) [CTL-16-090](#) [RM300-000-581-0000](#) [CY4600-000](#) [CY4601-000](#) [38111-14-15SN](#) [38112-14-15PN](#) [MMA23-0111R1](#) [MMD25-0071P1](#) [33516062020](#) [33526M11-08PE](#) [DMC-M99-01AN](#) [Y59113WE20PNV00300](#) [ZPF000000000106310](#) [105979-31](#) [EN4165M01AD0G0](#)