

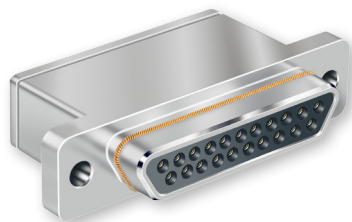

**790-025S**  
**Crimp Terminated Cable Plug Connector,**  
**Socket Contacts**  
**How To Order**

**790-025S Cable Plugs**

**SOCKET CONTACTS WITH CRIMP TERMINATION**



790-025S connectors feature machined aluminum shells and wire grommets for environmental protection. Contacts are rear-release snap-in crimp type. Connectors are supplied with crimp contacts packaged separately. Size #23 signal pins accept up to #22 AWG wire. Size #16 contacts accept #16-18 AWG wire. Size #12 contacts accept #12-14 AWG wire. Size 12 and 16 cavities also accept coaxial contacts purchased separately. Connector shell features a groove for attachment of a low-profile EMI adapter 799-015, ordered separately.

**HOW TO ORDER**

**Sample Part Number**

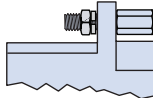
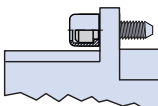
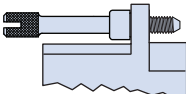
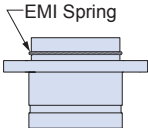
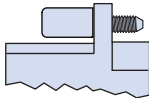
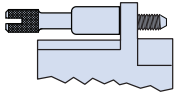
790-025S	H-5P5	E	M	S	
Part Number	Shell Size - Insert Arrangement	EMI Spring	Shell Finish	Hardware Option	
<b>790-025S</b> Cable Plug With Socket Contacts	See Table 1 for Available Insert Arrangements  To order a connector without size #16 or #12 power pins, substitute "W" instead of "P" in the insert arrangement.  Example:  <b>36P2</b> is supplied with 2 power pins.  <b>36W2</b> is supplied less the power pins.  See Section B for coaxial contacts purchased separately.	<b>E</b> EMI Spring	<b>M</b> Electroless Nickel <i>general purpose applications</i>	 <b>N</b> Thru-Hole No Hardware	 <b>P</b> Female Jackpost
		<b>N</b> No Spring	<b>MT</b> Nickel-PTFE <i>1000 Hour Grey™ maximum corrosion protection and durability (non-reflective grey)</i>	 <b>L</b> Low-Profile Captivated Jackscrew, Hex Head	 <b>K</b> Slot-Head Extended Jackscrew
		 <b>Note:</b> EMI Spring is not compatible with chromate finishes including cadmium and zinc-nickel	<b>ZNU</b> Zinc-Nickel with Black Chromate <i>tactical applications (non-reflective black)</i>	 <b>S</b> Low-Profile Captivated Screwlock, Hex Head	 <b>T</b> Slot-Head Extended Captivated Screwlock
			Additional shell finishes are listed on page C-9.		

**SPECIFICATIONS**

Current Rating	#23 5 AMPS, #16 13 A., #12 23 A.
Dielectric Withstanding Voltage	#23 500 VAC RMS, #12 and #16 1800 VAC RMS
Insulation Resistance	5000 megohms minimum
Operating Temperature	-65° C. to +150° C.
Shock	300 g.
Vibration	37 g.

**MATERIALS AND FINISHES**

Shell	Aluminum alloy
Contacts	Copper alloy, 50 microinches gold plated, stainless steel hood
Insulators	Liquid crystal polymer (LCP)
Retention Clips	Beryllium copper alloy
Grommet	Flourosilicone rubber
Hardware	300 series stainless steel

Dimensions in Inches (millimeters) are subject to change without notice.

# 790-025S Crimp Terminated Cable Plug Connector, Socket Contacts How To Order



**Table 1 Contact Arrangements**

Layout	Contact Quantity			Face View
	#23	#16	#12	
A-5	5			
B-2P2		2		
B-9	9			
C-13	13			
D-15	15			
D-3P3		3		
D-7P2	5	2		
E-11P2	9	2		
E-19	19			
E-7P3	4	3		
F-15P2	13	2		
F-23	23			
F-5P5		5		
G-33	33			
H-10P4	6	4		
H-29P7	22	7		
H-36P2	34	2		
H-54P2	52	2		
H-5P5		5		
H-66	66			
J-17P4	13	4		
J-25P2	23	2		
J-33	33			
J-7P7		7		
K-27P4	23	4		
K-35P2	33	2		
K-43	43			
K-9P9		9		
L-6P6		6		
L-78	78			
M-102	102			

**CROSS-SECTIONAL VIEW OF 790-025S**

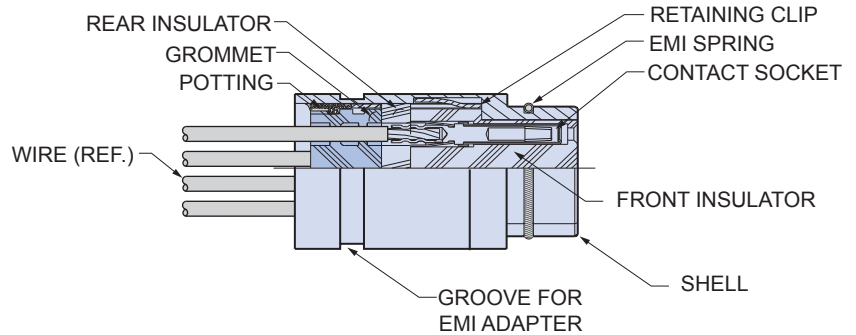

**TABLE 2 HARDWARE OPTION**

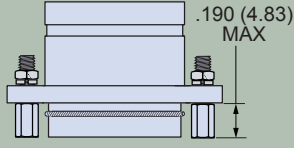
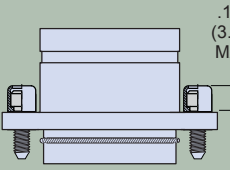
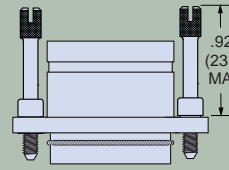
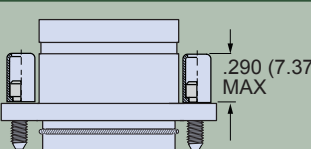
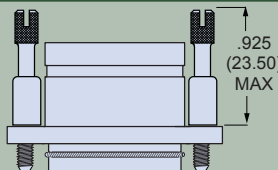
 <b>N</b> <b>No Mating Hardware</b> Connector is supplied with thru-holes. Shell sizes H and L are .148" (3.76) diameter, other shell sizes are .092" (2.34) diameter. Accepts standard Micro-D M83513 hardware.	 <b>P</b> <b>Jackposts</b> Connector is supplied with removable jackposts. Shell sizes H and L have #4-40 UNC thread, other sizes have #2-56 thread. Stainless steel. Conforms to M83513/05. <p style="text-align: right;">.190 (4.83) MAX</p>
 <b>L</b> <b>Hex Head Jackscrews</b> Connector is supplied with stainless steel non-removable low profile jackscrews. Shell sizes H and L have #4-40 UNC thread, other sizes have #2-56 thread. <p style="text-align: right;">.155 (3.94) MAX</p>	 <b>K</b> <b>Extended Jackscrews</b> Connector is supplied with stainless steel slot head non-removable jackscrews. Shell sizes H and L have #4-40 UNC thread, other sizes have #2-56 thread. <p style="text-align: right;">.925 (23.5) MAX</p>
 <b>S</b> <b>Hex Head Screwlocks</b> Connector is supplied with stainless steel non-removable low profile screwlocks. Shell sizes H and L have #4-40 UNC thread, other sizes have #2-56 thread. Screwlocks allow the connector to be mated before the screws are fastened. <p style="text-align: right;">.290 (7.37) MAX</p>	 <b>T</b> <b>Extended Screwlocks</b> Connector is supplied with stainless steel non-removable slot head screwlocks. Shell sizes H and L have #4-40 UNC thread, other sizes have #2-56 thread. Screwlocks allow the connector to be mated before the screws are fastened. <p style="text-align: right;">.925 (23.50) MAX</p>

Dimensions in Inches (millimeters) are subject to change without notice.



# 790-025S Crimp Terminated Cable Plug Connector, Socket Contacts Dimensions

## 790-025S Dimensions

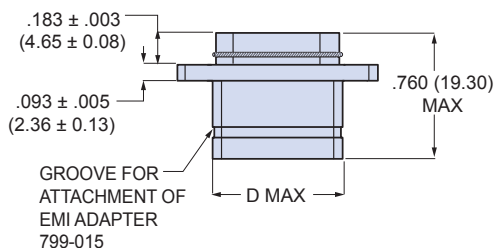
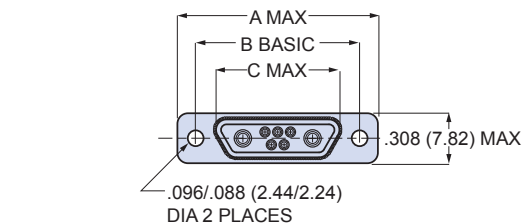

**SHELL SIZES A, B, C, D, E, F, J, K**

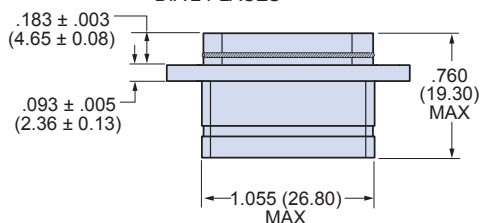
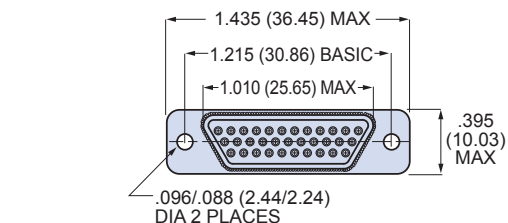

**SHELL SIZE G**

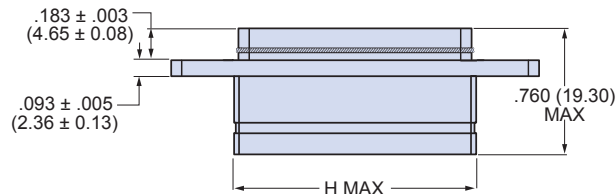
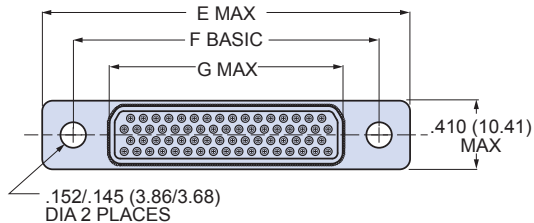

**SHELL SIZE H AND L**

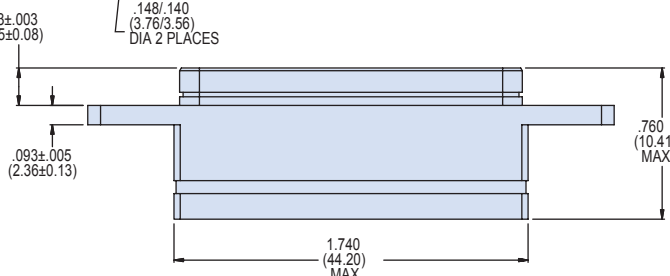
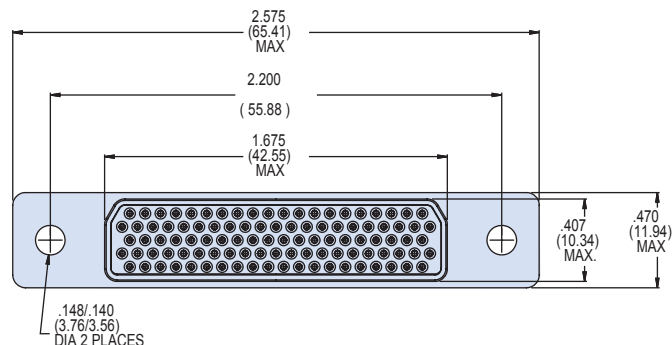

**SHELL SIZE M**

### 790-025S DIMENSIONS

Shell Size	A Max.		B Basic		C Max.		D Max.		E Max.		F Basic		G Max.		H Max.	
	In.	mm.	In.	mm.	In.	mm.	In.	mm.	In.	mm.	In.	mm.	In.	mm.	In.	mm.
A	.785	19.94	.565	14.35	.335	8.51	.390	9.91	—	—	—	—	—	—	—	—
B	.935	23.75	.715	18.16	.485	12.32	.540	13.72	—	—	—	—	—	—	—	—
C	1.085	27.56	.865	21.97	.635	16.13	.690	17.53	—	—	—	—	—	—	—	—
D	1.185	30.10	.965	24.51	.735	18.67	.790	20.07	—	—	—	—	—	—	—	—
E	1.335	33.91	1.115	28.32	.885	22.48	.940	23.88	—	—	—	—	—	—	—	—
F	1.485	37.72	1.265	32.13	1.035	26.29	1.090	27.69	—	—	—	—	—	—	—	—
H	—	—	—	—	—	—	—	—	2.175	55.25	1.800	45.72	1.385	35.18	1.440	36.58
J	1.845	46.86	1.615	41.02	1.390	35.61	1.450	36.83	—	—	—	—	—	—	—	—
K	2.240	56.90	2.015	51.18	1.795	45.59	1.840	46.74	—	—	—	—	—	—	—	—
L	—	—	—	—	—	—	—	—	2.420	61.47	2.036	51.71	1.623	41.22	1.675	42.55

Dimensions in Inches (millimeters) are subject to change without notice.

## X-ON Electronics

Largest Supplier of Electrical and Electronic Components

*Click to view similar products for [D-Sub Mixed Contact Connectors](#) category:*

*Click to view products by [Glenair](#) manufacturer:*

Other Similar products are found below :

[790-025SF-5P5NMN](#) [790-025SJ-7P7NML](#) [DAM-7W2PC](#) [L717TWB5W5P3R](#) [L717TWB5W5PRM84](#) [L717TWP3W3P](#)  
[3003W3PXX56N40X](#) [3005W5PXX99A30X](#) [3005W5PXX99E40X](#) [3005W5SXX99A30X](#) [3005W5SXX99E40X](#) [3013W6SCM99A10X](#)  
[3036W4PCM41A10X](#) [3036W4SCM99A10X](#) [FCE17-E2W2SS-2N0](#) [212522-7](#) [PII-468-1](#) [3003W3PXX43A10X](#) [3003W3SXX56N40X](#)  
[3005W5PXX88N40X](#) [3007W2PAR71E20X](#) [3008W8SXX57A30X](#) [3009W4PCT57P20X](#) [3011W1SXX99A10X](#) [3013W3PCM99A10X](#)  
[3017W2SAR69C40X](#) [321WA4PXK99A60X](#) [3F3SSC22S41A30X](#) [L717TWA7W2PP2SY3R](#) [DBM-17W2S-1A8N-A190-A197-1](#)  
[421WA4PCR50E20X](#) [09691009009](#) [09691100022500](#) [09693009176](#) [09692009147](#) [09693909015](#) [6017W2PCM41B30X](#) [790-061SH-](#)  
[36W2NMNA](#) [790-044SE-7P3MNPB](#) [790-043PE-11P2MPA](#) [790-043PB-2P2MPB](#) [790-029SB-2P2MEPA](#) [790-028PK-9P9MPA](#) [790-028PH-](#)  
[54P2MGA](#) [790-028PH-36P2MNA](#) [790-028PB-2P2MPA](#) [790-027SH-5W5MTEP](#) [790-026PH-54P2ZNUG](#) [790-026PH-54P2MP](#) [790-026PH-](#)  
[36P2ZNUG](#)