

**790-028P**  
**Straight PCB Terminated**  
**Panel Mount Receptacle, Pin Contacts**  
**How To Order**



**790-028P Straight PCB Panel Mount Receptacle**  
**PIN CONTACTS WITH STRAIGHT PCB TERMINATION**

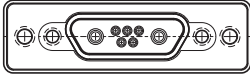
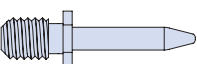
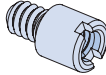
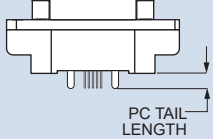
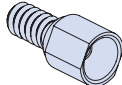

790-028P connectors are designed for rear-panel mounting and are supplied with conductive panel gaskets. These connectors feature machined aluminum shells, fluorosilicone face seals and straight printed circuit board contacts. Contacts are epoxy-encapsulated and are non-removable. Contacts are gold plated. Connector shells provide blind threaded holes for attaching to panel and to printed circuit board. Available in 29 different insert arrangements, these connectors feature size #23 contacts for signal and data. For higher current applications, size #16 contacts provide up to 13 amps and size #12 contacts handle up to 23 amps.

HOW TO ORDER				
Sample Part Number				
790-028P	J-25P2	M	P	A
Part Number	Shell Size - Insert Arrangements	Shell Finish	Hardware Option	PC Tail Length
<b>790-028P</b> Rear Panel Mounted Receptacle with PC Tail Pin Contacts for Termination to Backplanes or Flexible Circuits	See Table 1 for Available Insert Arrangements	<b>M</b> Electroless Nickel <i>general purpose applications</i>	 <b>N</b> No Hardware	<b>A</b> .125 Inch (3.2 mm.)
		<b>MT</b> Nickel-PTFE 1000 Hour Grey™ <i>maximum corrosion protection and durability (non-reflective grey)</i>	 <b>G</b> Guide Pin	<b>B</b> .250 inch (6.4 mm.)
		<b>ZNU</b> Zinc-Nickel with Black Chromate <i>tactical applications (non-reflective black)</i>	 <b>P</b> Female Jackpost	 PC TAIL LENGTH
		Additional shell finishes are listed on page C-9.	 <b>S</b> Female Guide Socket	

SPECIFICATIONS	
Current Rating	#23 5 AMPS, #16 13 A., #12 23 A.
Dielectric Withstanding Voltage	#23 500 VAC RMS, #12 and #16 1800 VAC RMS
Insulation Resistance	5000 megohms minimum
Operating Temperature	-65° C. to +150° C.
Shock	300 g.
Vibration	37 g.

MATERIALS AND FINISHES	
Shell	Aluminum alloy
Contacts	Copper alloy, 50 microinches gold plated
Insulators	Liquid crystal polymer (LCP)
Retention Clips	Beryllium copper alloy
Interfacial Seal	Flourosilicone rubber
Hardware	300 series stainless steel
Panel Gasket	Fluorosilicone, conductive
Encapsulant	Epoxy

Dimensions in Inches (millimeters) are subject to change without notice.

Table Contact Arrangements				
Layout	Contact Quantity			Face View
	#23	#16	#12	
A-5	5			
B-2P2	2			
B-9	9			
C-13	13			
D-15	15			
D-3P3	3			
D-7P2	5	2		
E-11P2	9	2		
E-19	19			
E-7P3	4	3		
F-15P2	13	2		
F-23	23			
F-5P5	5			
G-33	33			
H-10P4	6	4		
H-29P7	22	7		
H-36P2	34	2		
H-54P2	52	2		
H-5P5		5		
H-66	66			
J-17P4	13	4		
J-25P2	23	2		
J-33	33			
J-7P7	7			
K-27P4	23	4		
K-35P2	33	2		
K-43	43			
K-9P9	9			
L-6P6		6		
L-78	78			
M-102	102			

### CROSS-SECTIONAL VIEW OF 790-028P

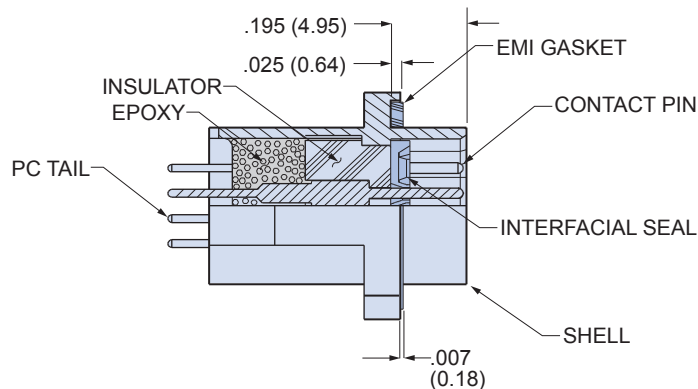

### TABLE 2 HARDWARE OPTION

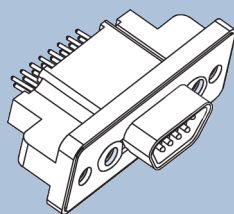

**N**

#### No Mating Hardware

Connector is supplied with threaded holes. Shell size M has #8-32 threads, shell sizes H and L have #6-32 threads, other sizes have #4-40 threads. Thread depth is .150" (3.8).

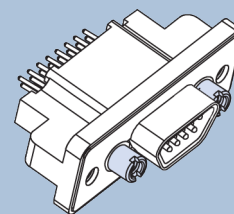

**P**

#### Jackposts

Connector is supplied with non-removable stainless steel jackposts. Shell size M has #6-32 threads, shell sizes H and L have #4-40 UNC thread, other sizes have #2-56 thread.

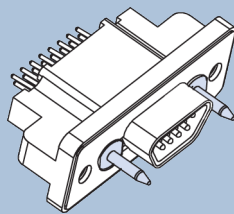

**G**

#### Guide Pins

Connector is supplied with stainless steel non-removable guide pins. Mates with type "S" guide sockets on corresponding plug connector.

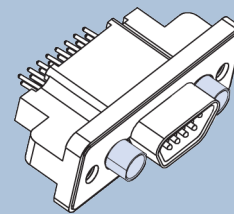

**S**

#### Guide Sockets

Connector is supplied with stainless steel non-removable bushings. Mates with type "G" guide pins on corresponding plug connector.

Dimensions in Inches (millimeters) are subject to change without notice.

**790-028P**  
**Straight PCB Terminated**  
**Panel Mount Receptacle, Pin Contacts**  
**Dimensions**



**790-028P Shell Size A, B, C, D, E, F, J and K Dimensions**

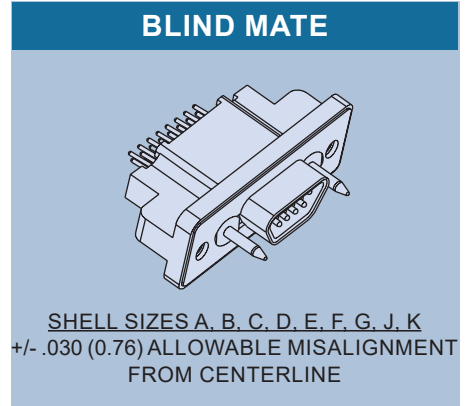
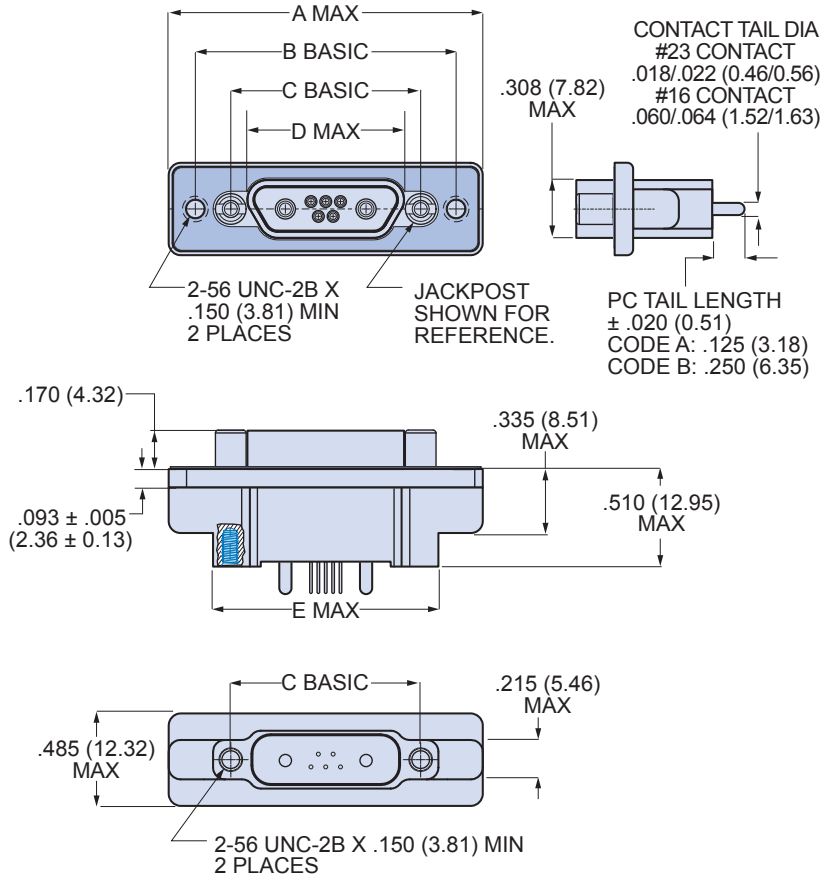

790-028P DIMENSIONS FOR SIZE A-F, J AND K										
Shell Size	A Max.		B Basic		C Basic		D Max.		E Max.	
	In.	mm.	In.	mm.	In.	mm.	In.	mm.	In.	mm.
A	1.211	30.76	.925	23.50	.565	14.35	.401	10.19	.760	19.30
B	1.361	34.57	1.075	27.31	.715	18.16	.551	14.00	.910	21.11
C	1.511	38.38	1.225	31.12	.865	21.97	.701	17.81	1.060	26.92
D	1.611	40.92	1.325	33.66	.965	24.51	.801	20.35	1.160	29.46
E	1.761	44.73	1.475	37.47	1.115	28.32	.951	24.16	1.310	33.27
F	1.911	48.54	1.625	41.28	1.265	32.13	1.101	27.96	1.460	37.08
J	2.261	57.43	1.975	50.17	1.615	41.02	1.460	37.08	1.810	45.97
K	2.661	67.59	2.375	60.33	2.015	51.18	1.860	47.24	2.210	56.13

Dimensions in Inches (millimeters) are subject to change without notice.

**790-028P Shell Size G Dimensions**

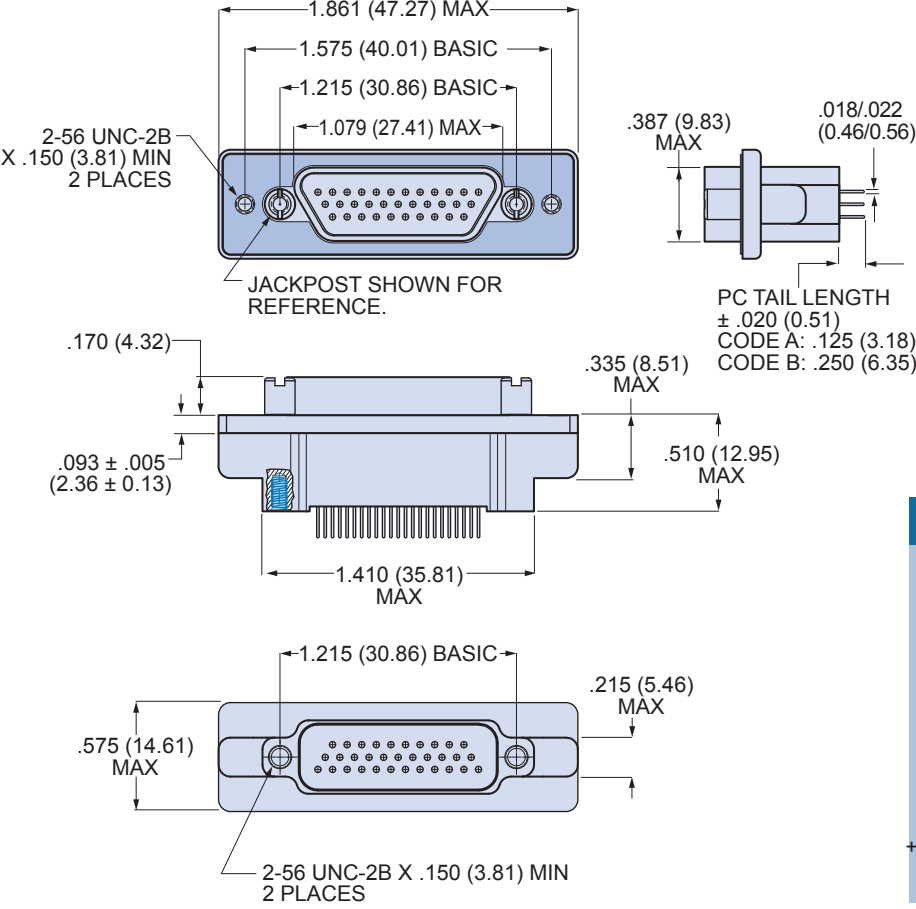

**BLIND MATE**

SHELL SIZES A, B, C, D, E, F, G, J, K  
 +/- .030 (0.76) ALLOWABLE MISALIGNMENT  
 FROM CENTERLINE

Dimensions in Inches (millimeters) are subject to change without notice.



# 790-028P Straight PCB Terminated Panel Mount Receptacle, Pin Contacts Dimensions



## 790-028P Shell Size H and L Dimensions

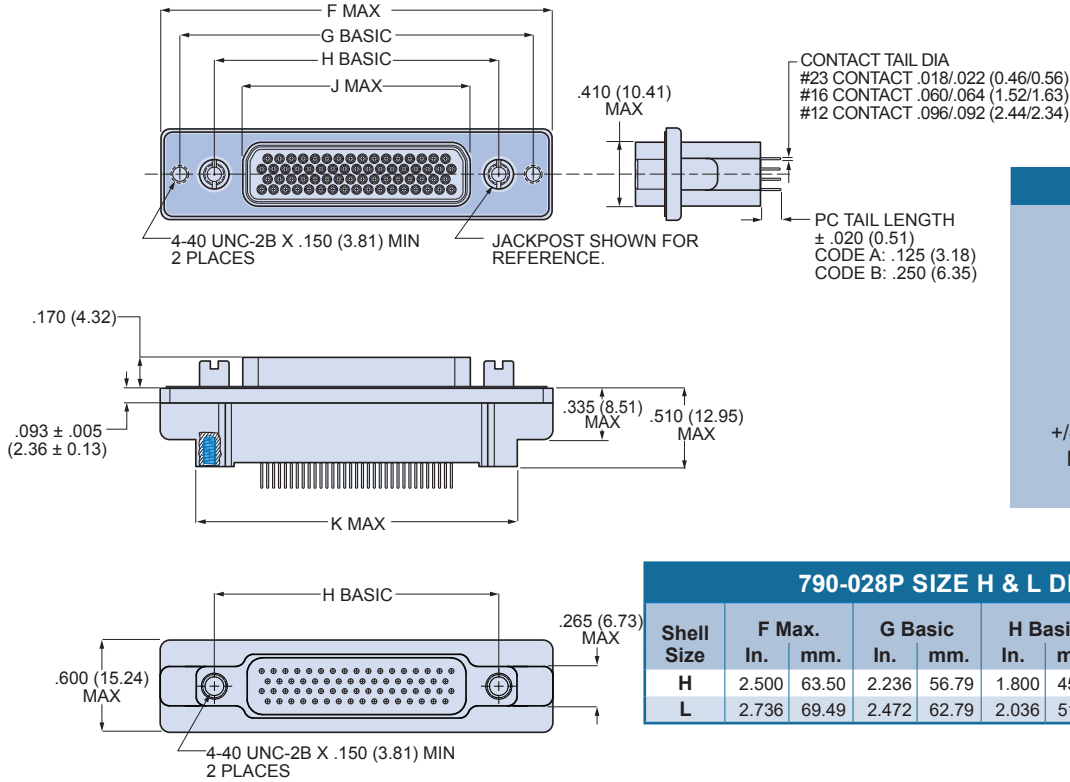

**BLIND MATE**

**SHELL SIZES H, L**  
+/- .040 (1.02) ALLOWABLE  
MISALIGNMENT FROM  
CENTERLINE

## 790-028P Shell Size M Dimensions

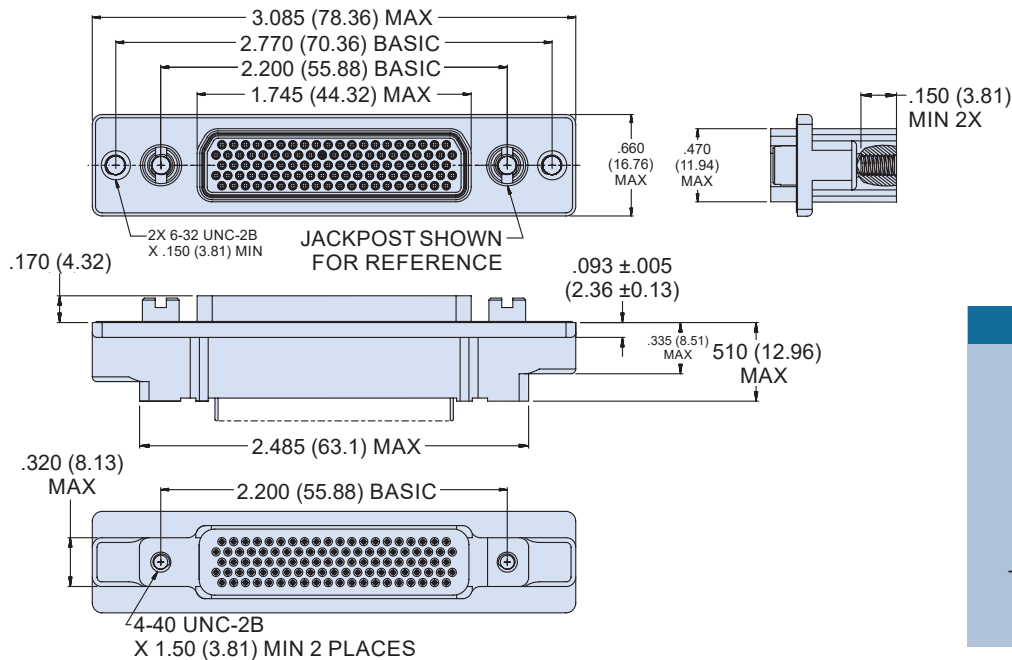

**BLIND MATE**

**SHELL SIZE M**  
+/- .050 (1.27) ALLOWABLE  
MISALIGNMENT FROM  
CENTERLINE

Dimensions in Inches (millimeters) are subject to change without notice.

## X-ON Electronics

Largest Supplier of Electrical and Electronic Components

*Click to view similar products for [D-Sub Micro-D Connectors](#) category:*

*Click to view products by [Glenair](#) manufacturer:*

Other Similar products are found below :

[89076GBEPR](#) [65-1920-15](#) [M83513/03-G05N](#) [M83513/03-G12N](#) [M83513/04-D11C](#) [M83513/04-G04C](#) [M83513/22-D01NP](#) [664020C06F060](#)  
[6R2004A30F015](#) [703006A13F060](#) [704002A03F200](#) [705001A13F120](#) [71-147714-19P](#) [7-1532020-5](#) [748567-1-P](#) [MDB1-31SH003](#) [MDB1-](#)  
[9SH001](#) [MDM-100PH003L](#) [MDM100PH006B](#) [MDM100SH006B](#) [MDM-15PCBRM7T](#) [MDM15PH006LA174](#) [MDM-15PH006P-A174](#)  
[MDM-15SH001L](#) [MDM-15SH003A](#) [MDM-15SH004B](#) [MDM-15SH006A-A174](#) [MDM-21PH001F](#) [MDM-21PH003P](#) [MDM21SH003BA174](#)  
[MDM21SH003P](#) [MDM-21SH003P-A174](#) [MDM-25PH005K](#) [MDM-25PHW01F-A174](#) [MDM-25SH001F-A174](#) [MDM-25SH003F](#) [MDM-](#)  
[25SH003K](#) [MDM-25SH006K](#) [MDM-31PH006B](#) [MDM31SH001F](#) [MDM-31SH003F](#) [MDM-31SH006F-A174](#) [MDM-31SH006P-A174](#)  
[MDM-31SH011F-A174](#) [MDM-31SH011P-A174](#) [MDM-37PH006L-A174](#) [MDM-37PH048M5-A174](#) [MDM-37SCBRP-A174](#) [MDM-](#)  
[37SH003K](#) [MDM-51PH003B-A174](#)