

890-012 and 890-013
 Right Angle Mount PCB, Single Row Nano Connector
 Surface Mount Type

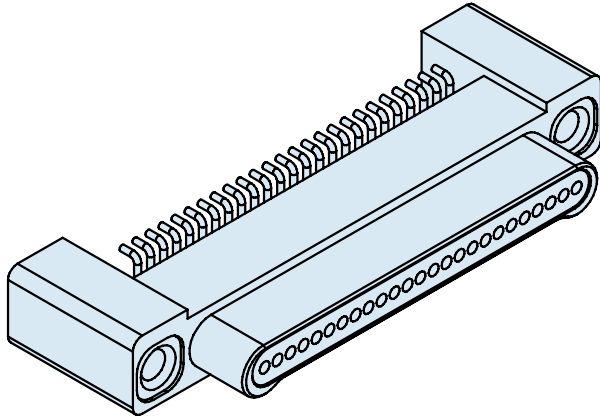

Right Angle SMT PCB Nano Connectors feature gold alloy TwistPin contacts. These nanominiature connectors offer premium performance and reliability for demanding applications. Available with #0-80 female threads.

Pre-Tinned PC Tails are coated with Sn63Pb37 tin-lead for excellent solderability.

Choose Aluminum, Titanium or Stainless Steel Shells in eight layouts from 5 to 51 contacts. Complies to the requirements of MIL-DTL-32139. These connectors are intermateable with any corresponding Glenair Series 890 single row metal shell nanominiature connector.

| How to Order Right Angle SMT PCB Connectors | | | | | |
|---|---|------|---|------|---|
| Sample Part Number | 890-012 | -51P | T | -BRS | T |
| Series | 890-012 Plug, Pin Contacts, Single Row, Right Angle SMT Nanominiature 890-013 Receptacle, Socket Contacts, Single Row, Right Angle SMT Nanominiature | | | | |
| Insert Arrangement/ Contact Type | Plugs (890-012): 5P, 9P, 15P, 21P, 25P, 31P, 37P, 51P , Receptacles (890-013): 5S, 9S, 15S, 21S, 25S, 31S, 37S, 51S | | | | |
| Shell Material and Finish | A1 - Aluminum Shell, Cadmium Plating A2 - Aluminum Shell, Electroless Nickel Plating | | T - Titanium Shell, Unplated S - Stainless Steel Shell, Passivated | | |
| Termination Type | BRS - Board Right Angle Surface Mount | | | | |
| Hardware | T - Female Thread, #0-80 | | | | |

Dimensions in inches (millimeters) and are subject to change without notice.

Single Row Nano Right Angle SMT Dimensions

890-012 Plug (Pin) Connectors

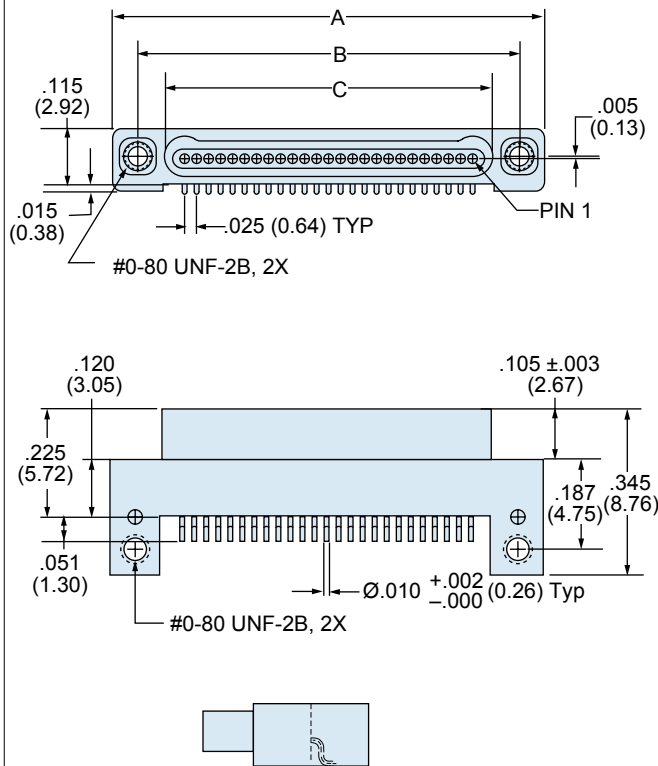

890-013 Receptacle (Socket) Connectors

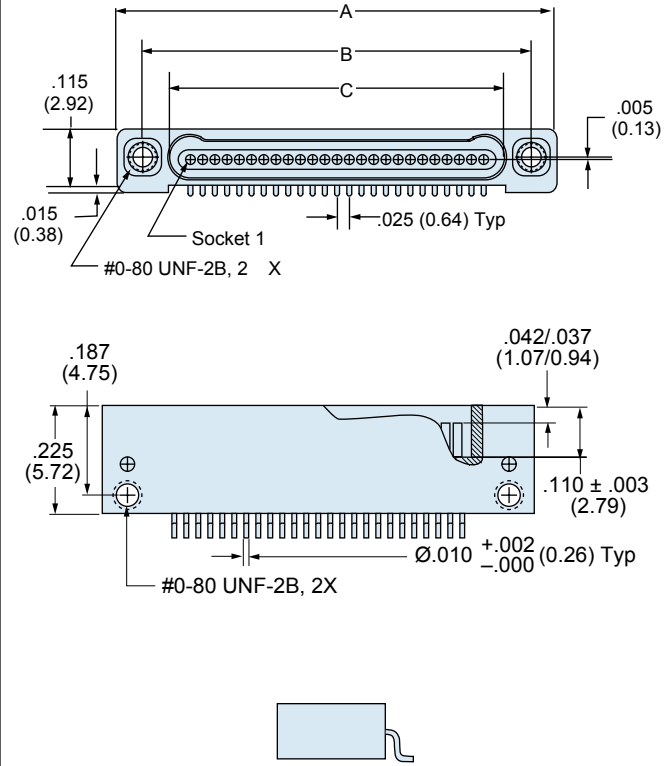

| Layout | A | | B BSC. | | C BSC. | |
|--------|------------|------------|--------|-------|--------|-------|
| | In. ± .005 | mm. ± 0.13 | In. | mm. | In. | mm. |
| 5P | .400 | 10.16 | .295 | 7.49 | .184 | 4.67 |
| 5S | .400 | 10.16 | .295 | 7.49 | .185 | 4.70 |
| 9P | .500 | 12.70 | .395 | 10.03 | .284 | 7.21 |
| 9S | .500 | 12.70 | .395 | 10.03 | .285 | 7.24 |
| 15P | .650 | 16.51 | .545 | 13.84 | .434 | 11.02 |
| 15S | .650 | 16.51 | .545 | 13.84 | .435 | 11.05 |
| 21P | .800 | 20.32 | .695 | 17.65 | .584 | 14.83 |
| 21S | .800 | 20.32 | .695 | 17.65 | .585 | 14.86 |
| 25P | .900 | 22.86 | .795 | 20.19 | .684 | 17.37 |
| 25S | .900 | 22.86 | .795 | 20.19 | .685 | 17.40 |
| 31P | 1.050 | 26.67 | .945 | 24.00 | .834 | 21.18 |
| 31S | 1.050 | 26.67 | .945 | 24.00 | .835 | 21.21 |
| 37P | 1.200 | 30.48 | 1.095 | 27.81 | .984 | 24.99 |
| 37S | 1.200 | 30.48 | 1.095 | 27.81 | .985 | 24.02 |
| 51P | 1.550 | 39.37 | 1.445 | 36.70 | 1.334 | 33.88 |
| 51S | 1.550 | 39.37 | 1.445 | 36.70 | 1.335 | 33.91 |

Dimensions in inches (millimeters) and are subject to change without notice.

890-012 and 890-013 Right Angle Mount PCB, Single Row Nano Connector Surface Mount Type



Single Row
Connectors

Right Angle SMT Plug (Pin) Connector Layout 890-012

5 Contacts

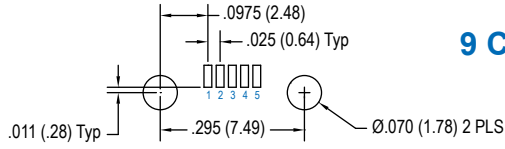

9 Contacts

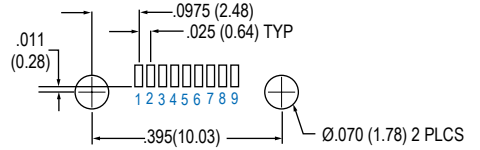

15 Contacts

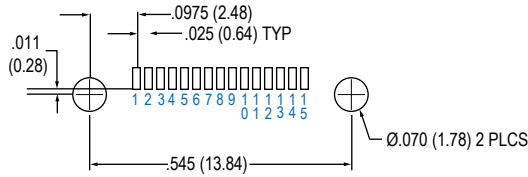

21 Contacts

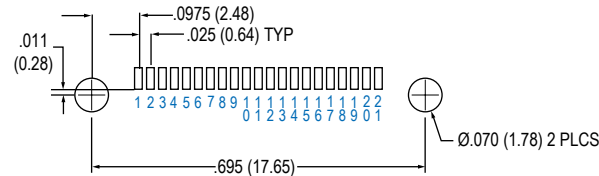

25 Contacts

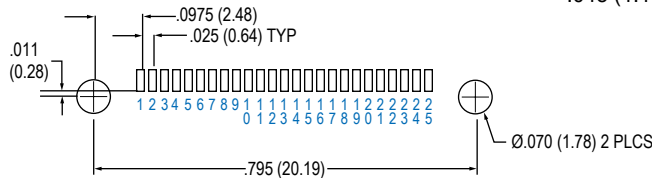

31 Contacts

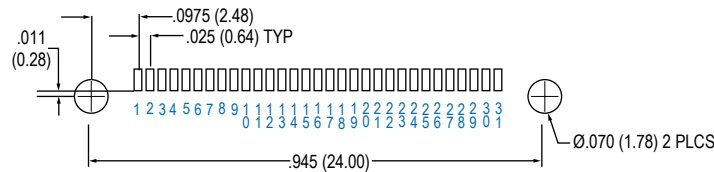

37 Contacts

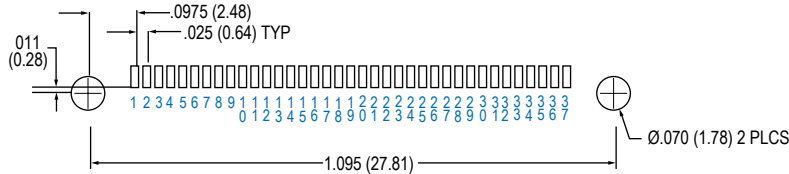

51 Contacts

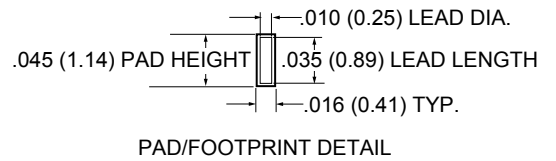
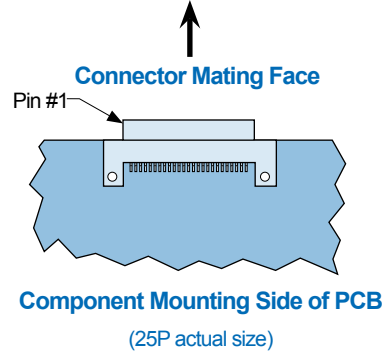
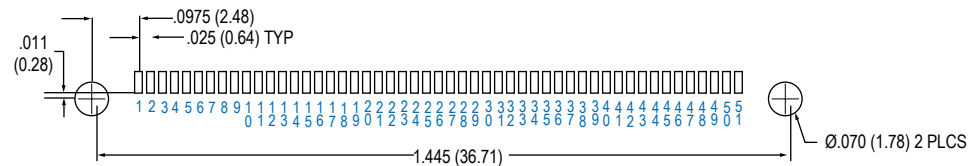

Layouts shown are for connector mounting side of PC Board.





890-012 and 890-013 Right Angle Mount PCB, Single Row Nano Connector Surface Mount Type

Right Angle SMT Receptacle (Socket) Connector Layout 890-013

5 Contacts

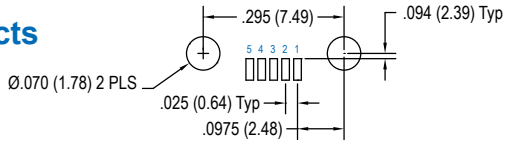

9 Contacts

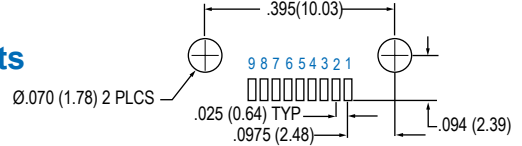

15 Contacts

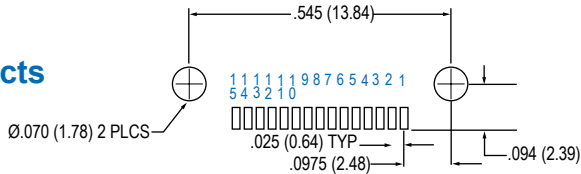

21 Contacts

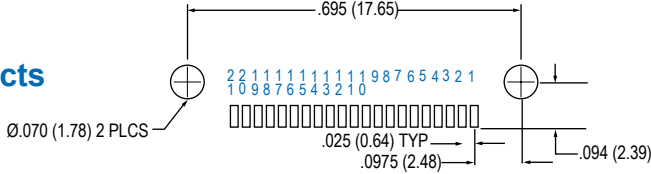

25 Contacts

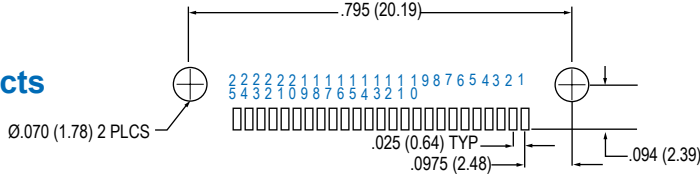

31 Contacts

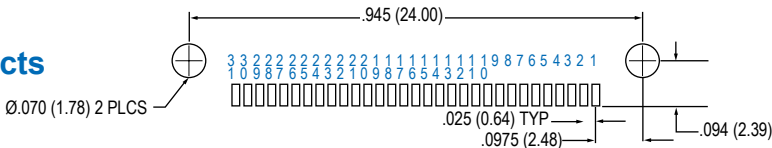

37 Contacts

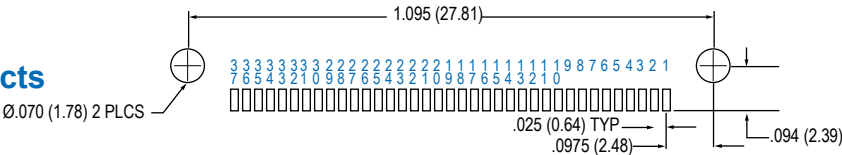

51 Contacts

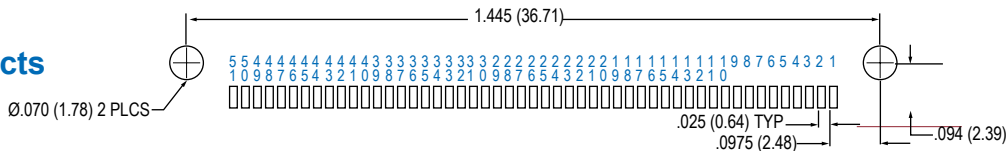

Connector Mating Face

Socket #1

Component Mounting Side of PCB

(25S actual size)

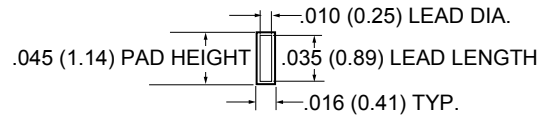

PAD/FOOTPRINT DETAIL

Layouts shown are for connector mounting side of PC Board.

X-ON Electronics

Largest Supplier of Electrical and Electronic Components

Click to view similar products for [Rectangular MIL Spec Connectors](#) category:

Click to view products by [Glenair](#) manufacturer:

Other Similar products are found below :

[891-011-15SA2-BSST](#) [CTS-S16/16](#) [65002-062](#) [CY4602-000](#) [732-8020-01](#) [77058-22-55PN](#) [81542-20](#) [86.030.0053.0](#) [1241346-1](#) [RM252-020-311-2900](#) [DMC-M 08-16 SA](#) [1589051-4](#) [MSO34MPK1E1](#) [BACC65CAMA](#) [BACC65CP1PN](#) [BACI10BC0816PNBA](#) [HSB-D4S03DM222X](#) [2217548-1](#) [891-006-9PS-BST1T](#) [891-009-15SA2-BRT1T](#) [27963-20T12](#) [SIM2S100A](#) [1604996-2](#) [SMD25PN90L-4055](#) [1900ND08S1B00A](#) [22628-10-6P-791](#) [33526M11-08PD](#) [RE04-212S](#) [M32139/03-G05SN](#) [CTD160E01F-6148](#) [CTJ112E03B](#) [CTJ122E02D-8000](#) [CTJ-3D-12](#) [CTJ920E06N-513](#) [CTJ920E12N-513](#) [CTL-16-090](#) [RM300-000-581-0000](#) [CY4600-000](#) [CY4601-000](#) [38111-14-15SN](#) [38112-14-15PN](#) [MMA23-0111R1](#) [MMD25-0071P1](#) [33516062020](#) [33526M11-08PE](#) [DMC-M99-01AN](#) [Y59113WE20PNV00300](#) [ZPF000000000106310](#) [105979-31](#) [EN4165M01AD0G0](#)