

AS85049/37 and M38999/8 90° EMI/RFI Non-Environmental Backshell



AS85049

B

CONNECTOR DESIGNATOR:

F MIL-DTL-38999 Series I and II

Finish
N = Electroless Nickel *X* = Nickel Fluorocarbon Polymer
W = 1,000 Hr. Cadmium Olive Drab over Electroless Nickel *Z* = Zinc-Nickel, Black

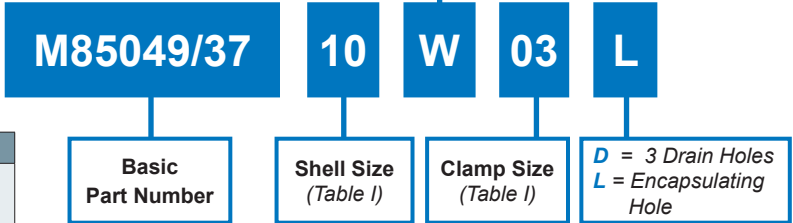

TABLE I: Shell Size

Shell Size Series II	Series I Shell Size Ref.	A Thread Class 2B	C Dia Max
08	09	.438 - 28 UNEF	.750 (19.1)
10	11	.562 - 24 UNEF	.850 (21.6)
12	13	.688 - 24 UNEF	1.000 (25.4)
14	15	.813 - 20 UNEF	1.100 (27.9)
16	17	.938 - 20 UNEF	1.250 (31.8)
18	19	1.063 - 18 UNEF	1.400 (35.6)
20	21	1.188 - 18 UNEF	1.500 (38.1)
22	23	1.313 - 18 UNEF	1.650 (41.9)
24	25	1.438 - 18 UNEF	1.750 (44.5)

TABLE II: Clamp Size and Dimensions

Shell Size Series II	Series I Shell Size Ref.	E Max	F Max	Clamp Size Min	Clamp Size Max
8	09	.720 (18.3)	2.88 (73.15)	01	02
10	11	.720 (18.3)	2.92 (74.17)	01	03
12	13	.800 (20.3)	3.06 (77.72)	02	04
14	15	.850 (21.6)	3.24 (82.30)	02	05
16	17	.910 (23.1)	3.44 (87.38)	02	06
18	19	1.000 (25.4)	3.73 (94.74)	03	06
20	21	1.050 (26.7)	3.94 (100.08)	03	07
22	23	1.100 (27.9)	4.14 (105.16)	03	08
24	25	1.200 (30.5)	4.19 (106.43)	04	09

TABLE II: Clamp Size and Dimensions

Clamp Size	Cable Range		G Max
	Min	Max	
01	.062 (1.6)	.125 (3.2)	.781 (19.8)
02	.125 (3.2)	.250 (6.4)	.969 (24.6)
03	.250 (6.4)	.375 (9.5)	1.062 (27.0)
04	.312 (7.9)	.500 (12.7)	1.156 (29.4)
05	.437 (11.1)	.625 (15.9)	1.250 (31.8)
06	.562 (14.3)	.750 (19.1)	1.375 (34.9)
07	.687 (17.4)	.875 (22.2)	1.500 (38.1)
08	.812 (20.6)	1.000 (25.4)	1.625 (41.3)
09	.937 (23.8)	1.125 (28.6)	1.750 (44.5)

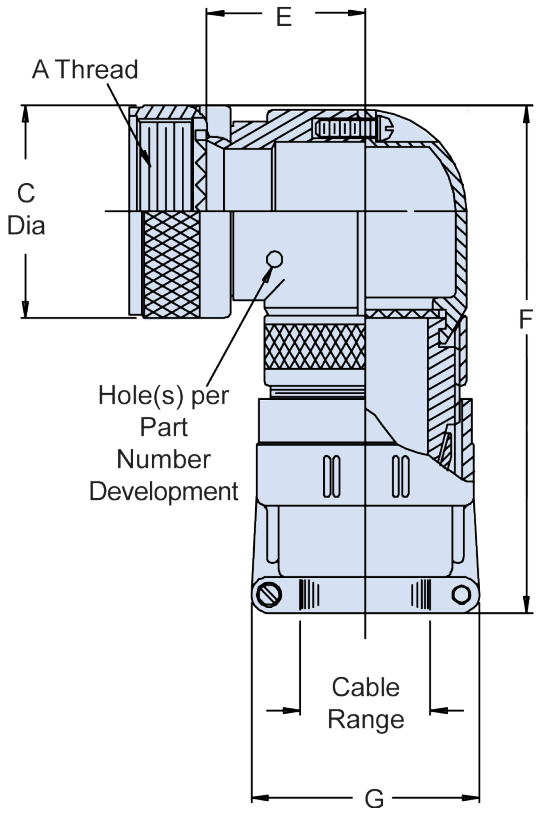

APPLICATION NOTES

- For complete dimensions see the applicable Military Specification.
- Metric dimensions (mm) are in parentheses.
- Cable Range is defined as the accommodation range for the wire bundle or cable. Dimensions shown are not intended for inspection criteria.

Dimensions in inches (millimeters) and are subject to change without notice.

X-ON Electronics

Largest Supplier of Electrical and Electronic Components

Click to view similar products for [Circular MIL Spec Backshells](#) category:

Click to view products by [Glenair](#) manufacturer:

Other Similar products are found below :

[60-036152-022](#) [610HS012M15](#) [M28840/504WA](#) [M28840/805WB](#) [M28840/809WA](#) [M28840/815WA](#) [M28840/816WA](#) [627AS017M14](#)
[627MA124M14S](#) [655HS002NF11](#) [CW3899-000](#) [M85049/10-134S](#) [M85049/10-17S](#) [M85049/10-33S](#) [M85049/10-94W](#) [M85049/11-28N](#)
[M85049/11-37N](#) [M85049/11-53N](#) [M85049/11-63N](#) [M85049/124-23W](#) [M85049/1720N04B](#) [M85049/1821W05C](#) [M85049/1825W06C](#)
[M85049/1919N05](#) [M85049/23-74W](#) [M85049/24-71N](#) [M85049/25-47N](#) [M85049/25-94W](#) [M85049/27S12N](#) [M85049/39-11S](#) [M85049/39-17S](#)
[M85049/39-9S](#) [M85049/6-10B](#) [M85049/6-19N](#) [M85049/6-20B](#) [M85049/77-20W04](#) [M85049/78-11N03](#) [M85049/78-15W02](#) [M85049/78-](#)
[17N04](#) [M85049/78-19N05](#) [M85049/79-19N07](#) [M85049/79-25N04](#) [M85049/82-18N02](#) [M85049/82-22P02](#) [M85049/83-10W03](#) [M85049/84-](#)
[20N03](#) [M85049/8-48N](#) [M85049/85-24N01](#) [M85049/85-24P01](#) [M85049/86-16P03](#)