

## Power Distribution Switch

### Features

- 90mΩ High-Side MOSFET (G547E,G547F,G547G,G547H, G547M)
- Available with 5 Versions of Current Limits with Foldback
- Operating Range:2.7V to 5.5V
- 1mS Typical Rise Time
- Fast Overcurrent Response -3μs (TYPICAL)
- Under voltage Lockout
- 100μA Quiescent Supply Current
- 1μA Maximum Shutdown Supply Current
- Logic Level Enable Pin, Available with Active-High or Active-Low Version
- No Reverse Current when Power Off
- Deglitched Open-Drain Over-Current Flag Output (OC)
- With Output Shutdown Pull-low Resistor
- SOT-23-6, SOP-8, MSOP-8 and TDFN3X3-8 Packages
- UL Approved #E232223
- Nemko IEC 60950-1 CB/CCA\_scheme Certification Report #67291

### General Description

The G547 is an integrated power switch for self-powered and bus-powered Universal Serial Bus (USB) applications. G547E, G547F, G547G,G547H and G547M are 90mΩ  $R_{DS(ON)}$ .

Several Protection features include current limiting with foldback, and thermal shutdown to prevent catastrophic switch failure caused by increasing power dissipation when continuous heavy loads or short circuit occurs. A built-in charge pump is used to drive the N-channel MOSFET that is free of parasitic body diode to eliminate any reversed current flow across the switch when it is powered off.

OC is open-drain output report over-current or over-temperature event and has typical 9ms deglitch timeout period.

### Applications

- High-Side Power Protection Switch
- USB Power Management
- USB Host and Self-Powered Bubs
- USB Bus-Powered Hubs
- Hot Plug-in Power Supplies
- Battery-Charger Circuits

### Pin Configuration

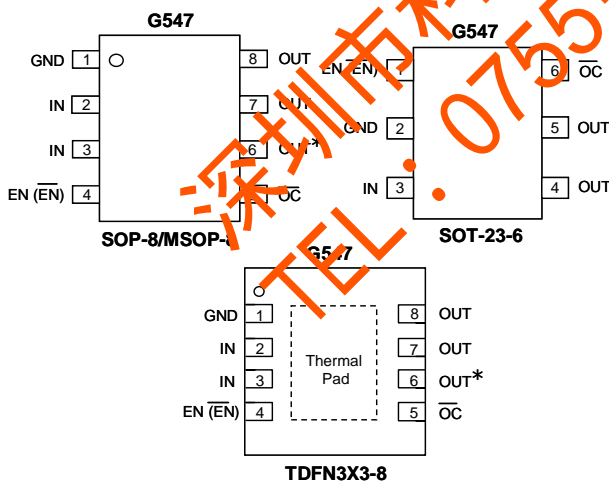

Note: Recommend connecting the Thermal Pad to the GND for excellent power dissipation.

\*Pin#6 should be considered as OUT when circuit design and PCB layout, but it is NC pin actually.

### Typical Application Circuit

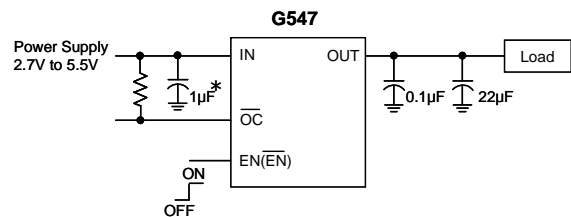

\*: 1μF of input capacitor is enough in most application cases. If the PCB trace of power rail to IN is long, larger input capacitor is necessary.



UL Recognized Component

## Ordering Information

| ORDER NUMBER | MARKING | ENABLE      | Current Limit | Output MOS R <sub>DS(ON)</sub> | Output Shutdown Resistor | TEMP. RANGE    | PACKAGE (Green) |
|--------------|---------|-------------|---------------|--------------------------------|--------------------------|----------------|-----------------|
| G547E1TB1U   | 57EAx   | Active High | 2.5A          | 90mΩ                           | Yes                      | -40°C to +85°C | SOT-23-6        |
| G547E2TB1U   | 57EBx   | Active Low  | 2.5A          | 90mΩ                           | Yes                      | -40°C to +85°C | SOT-23-6        |
| G547F1TB1U   | 57FAx   | Active High | 2A            | 90mΩ                           | Yes                      | -40°C to +85°C | SOT-23-6        |
| G547F2TB1U   | 57FBx   | Active Low  | 2A            | 90mΩ                           | Yes                      | -40°C to +85°C | SOT-23-6        |
| G547G1TB1U   | 57GAx   | Active High | 1.5A          | 90mΩ                           | Yes                      | -40°C to +85°C | SOT-23-6        |
| G547G2TB1U   | 57GBx   | Active Low  | 1.5A          | 90mΩ                           | Yes                      | -40°C to +85°C | SOT-23-6        |
| G547H1TB1U   | 57HAx   | Active High | 1A            | 90mΩ                           | Yes                      | -40°C to +85°C | SOT-23-6        |
| G547H2TB1U   | 57HBx   | Active Low  | 1A            | 90mΩ                           | Yes                      | -40°C to +85°C | SOT-23-6        |
| G547M1TB1U   | 57MAx   | Active High | 3.7A          | 90mΩ                           | Yes                      | -40°C to +85°C | SOT-23-6        |
| G547M2TB1U   | 57MBx   | Active Low  | 3.7A          | 90mΩ                           | Yes                      | -40°C to +85°C | SOT-23-6        |
| G547E1P11U   | G547E1  | Active High | 2.5A          | 90mΩ                           | Yes                      | -40°C to +85°C | SOP-8           |
| G547E2P11U   | G547E2  | Active Low  | 2.5A          | 90mΩ                           | Yes                      | -40°C to +85°C | SOP-8           |
| G547F1P11U   | G547F1  | Active High | 2A            | 90mΩ                           | Yes                      | -40°C to +85°C | SOP-8           |
| G547F2P11U   | G547F2  | Active Low  | 2A            | 90mΩ                           | Yes                      | -40°C to +85°C | SOP-8           |
| G547G1P11U   | G547G1  | Active High | 1.5A          | 90mΩ                           | Yes                      | -40°C to +85°C | SOP-8           |
| G547G2P11U   | G547G2  | Active Low  | 1.5A          | 90mΩ                           | Yes                      | -40°C to +85°C | SOP-8           |
| G547H1P11U   | G547H1  | Active High | 1A            | 90mΩ                           | Yes                      | -40°C to +85°C | SOP-8           |
| G547H2P11U   | G547H2  | Active Low  | 1A            | 90mΩ                           | Yes                      | -40°C to +85°C | SOP-8           |
| G547M1P11U   | G547M1  | Active High | 3.7A          | 90mΩ                           | Yes                      | -40°C to +85°C | SOP-8           |
| G547M2P11U   | G547M2  | Active Low  | 3.7A          | 90mΩ                           | Yes                      | -40°C to +85°C | SOP-8           |
| G547E1P81U   | G547E1  | Active High | 2.5A          | 90mΩ                           | Yes                      | -40°C to +85°C | MSOP-8          |
| G547E2P81U   | G547E2  | Active Low  | 2.5A          | 90mΩ                           | Yes                      | -40°C to +85°C | MSOP-8          |
| G547F1P81U   | G547F1  | Active High | 2A            | 90mΩ                           | Yes                      | -40°C to +85°C | MSOP-8          |
| G547F2P81U   | G547F2  | Active Low  | 2A            | 90mΩ                           | Yes                      | -40°C to +85°C | MSOP-8          |
| G547G1P81U   | G547G1  | Active High | 1.5A          | 90mΩ                           | Yes                      | -40°C to +85°C | MSOP-8          |
| G547G2P81U   | G547G2  | Active Low  | 1.5A          | 90mΩ                           | Yes                      | -40°C to +85°C | MSOP-8          |
| G547H1P81U   | G547H1  | Active High | 1A            | 90mΩ                           | Yes                      | -40°C to +85°C | MSOP-8          |
| G547H2P81U   | G547H2  | Active Low  | 1A            | 90mΩ                           | Yes                      | -40°C to +85°C | MSOP-8          |
| G547M1P81U   | G547M1  | Active High | 3.7A          | 90mΩ                           | Yes                      | -40°C to +85°C | MSOP-8          |
| G547M2P81U   | G547M2  | Active Low  | 3.7A          | 90mΩ                           | Yes                      | -40°C to +85°C | MSOP-8          |
| G547E1RD1U   | 547E1   | Active High | 2.5A          | 90mΩ                           | Yes                      | -40°C to +85°C | TDFN3X3-8       |
| G547E2RD1U   | 547E2   | Active Low  | 2.5A          | 90mΩ                           | Yes                      | -40°C to +85°C | TDFN3X3-8       |
| G547F1RD1U   | 547F1   | Active High | 2A            | 90mΩ                           | Yes                      | -40°C to +85°C | TDFN3X3-8       |
| G547F2RD1U   | 547F2   | Active Low  | 2A            | 90mΩ                           | Yes                      | -40°C to +85°C | TDFN3X3-8       |
| G547G1RD1U   | 547G1   | Active High | 1.5A          | 90mΩ                           | Yes                      | -40°C to +85°C | TDFN3X3-8       |
| G547G2RD1U   | 547G2   | Active Low  | 1.5A          | 90mΩ                           | Yes                      | -40°C to +85°C | TDFN3X3-8       |
| G547H1RD1U   | 547H1   | Active High | 1A            | 90mΩ                           | Yes                      | -40°C to +85°C | TDFN3X3-8       |
| G547H2RD1U   | 547H2   | Active Low  | 1A            | 90mΩ                           | Yes                      | -40°C to +85°C | TDFN3X3-8       |
| G547M1RD1U   | 547M1   | Active High | 3.7A          | 90mΩ                           | Yes                      | -40°C to +85°C | TDFN3X3-8       |
| G547M2RD1U   | 547M2   | Active Low  | 3.7A          | 90mΩ                           | Yes                      | -40°C to +85°C | TDFN3X3-8       |

Note: TB: SOT-23-6 P1: SOP-8 P8: MSOP-8 RD: TDFN3X3-8

1: Bonding Code

U: Tape & Reel

## Absolute Maximum Ratings

|   |                    |
|---|--------------------|
| Supply Voltage ( $V_{IN}$ )                                 | 6V                 |
| Output Voltage ( $V_{OUT}$ )                                | 6V                 |
| Output Current ( $I_{OUT}$ )                                | Internally Limited |
| Enable Input ( $V_{EN}$ )                                   | -0.3V to 6V        |
| Thermal Resistance Junction to Ambient, ( $\theta_{JA}$ )*  |                    |
| SOT-23-6  | 250°C/W            |
| SOP-8   | 160°C/W            |
| MSOP-8  | 180°C/W            |
| TDFN3X3-8   | 170°C/W            |
| Continuous Power Dissipation ( $T_A = +25^\circ\text{C}$ )* |                    |
| SOT-23-6  | 0.5W               |

|                                       |                 |
|---------------------------------------|-----------------|
| SOP-8                                 | 0.71W           |
| MSOP-8                                | 0.64W           |
| TDFN3X3-8                             | 0.67W           |
| Junction Temperature                  | 150°C           |
| Storage Temperature ( $T_S$ )         | -65°C to +150°C |
| Reflow Temperature (soldering, 10sec) | 260°C           |
| ESD Protection                        | 2kV             |

## Operating Ratings

|                                 |                |
|---------------------------------|----------------|
| Supply Voltage ( $V_{IN}$ )     | 3V to 5.5V     |
| Operating Temperature ( $T_A$ ) | -40°C to +85°C |

\*Please refer to Minimum Footprint PCB Layout Section.

## Electrical Characteristics

$V_{IN} = 5V$ ,  $C_{IN} = 1\mu F$ ,  $C_{OUT} = 1\mu F$ ,  $R_L = 10\Omega$ ,  $T_A = 25^\circ\text{C}$ .

The device is not guaranteed to function outside its operating conditions. Parameters with MIN and/or MAX limits are 100% tested at +25°C, unless otherwise specified.

| PARAMETER                            | CONDITION  | MIN | TYP | MAX | UNITS |
|--------------------------------------|--|-----|-----|-----|-------|
| Input Voltage Range                  |  | 2.7 | --- | 5.5 | V     |
| Output MOS $R_{DS(ON)}$              | G547E1/G547E2, $I_{OUT} = 2A$                          | --- | 90  | 110 | mΩ    |
|                                      | G547F1/G547F2, $I_{OUT} = 1.5A$                        |     |     |     |       |
|                                      | G547G1/G547G2, $I_{OUT} = 1A$                          |     |     |     |       |
|                                      | G547H1/G547H2, $I_{OUT} = 0.5A$                        |     |     |     |       |
|                                      | G547M1/G547M2, $I_{OUT} = 2.5A$                        |     |     |     |       |
| Supply Current                       |  | --- | 100 | 135 | μA    |
| Output Turn-on Rising Time           | $R_L = 10\Omega$ , 90% Settling                        | 0.4 | 1   | 1.5 | ms    |
| Current Limit Threshold              | G547E1/G547E2, $V_{OUT} = 4V$                          | --- | 2.5 | 3   | A     |
|                                      | G547F1/G547F2, $V_{OUT} = 4V$                          |     |     |     |       |
|                                      | G547G1/G547G2, $V_{OUT} = 4V$                          |     |     |     |       |
|                                      | G547H1/G547H2, $V_{OUT} = 4V$                          |     |     |     |       |
|                                      | G547M1/G547M2, $V_{OUT} = 4V$                          |     |     |     |       |
| Short-circuit Current                | G547E1/G547E2, $V_{OUT} = 0V$ , $2.7V < V_{IN} < 5.5V$ | --- | 1.7 | 2.6 | A     |
|                                      | G547F1/G547F2, $V_{OUT} = 0V$ , $2.7V < V_{IN} < 5.5V$ |     |     |     |       |
|                                      | G547G1/G547G2, $V_{OUT} = 0V$ , $2.7V < V_{IN} < 5.5V$ |     |     |     |       |
|                                      | G547H1/G547H2, $V_{OUT} = 0V$ , $2.7V < V_{IN} < 5.5V$ |     |     |     |       |
|                                      | G547M1/G547M2, $V_{OUT} = 0V$ , $2.7V < V_{IN} < 5.5V$ |     |     |     |       |
| EN Input Threshold-High $V_{IH}$     |  | 1.4 | 1.6 | 1.8 | V     |
| EN Input Threshold-Low $V_{IL}$      |  | 0.8 | 1.3 | 1.6 | V     |
| Shutdown Supply Current              |  | --- | 0.1 | 1   | μA    |
| Shutdown Pull Low Resistance         |  | --- | 75  | 150 | Ω     |
| Output Leakage Current               | EN="0", $V_{OUT} = 0V$                                 | --- | 0.5 | 1   | μA    |
| $V_{IN}$ Under Voltage Lockout       |  | 2.2 | 2.5 | 2.7 | V     |
| $V_{IN}$ Under Voltage Hysteresis    |  | --- | 200 | --- | mV    |
| Thermal Limit                        |  | --- | 135 | --- | °C    |
| Thermal Limit Hysteresis             |  | --- | 20  | --- | °C    |
| $\overline{OC}$ Deglitch             | $\overline{OC}$ assertion or deassertion               | 4   | 9   | 15  | ms    |
| $\overline{OC}$ Output Low Voltage   | $I_{\overline{OC}} = 2mA$                              | --- | --- | 0.4 | V     |
| $\overline{OC}$ Off-State Current    | $V_{\overline{OC}} = 5V$                               | --- | --- | 1   | μA    |
| $t_S$ Response Time to Short Circuit | $V_{IN} = 5V$ , see figure 1.                          | --- | 3   | --- | μs    |

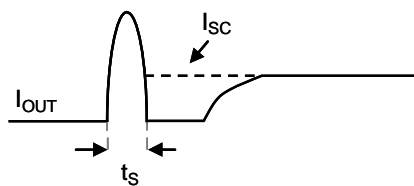
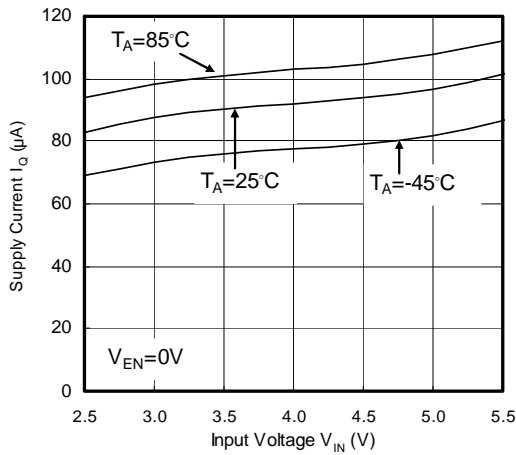

Figure 1

## Typical Performance Characteristics

( $V_{IN}=5V$ ,  $C_{IN}=1\mu F$ ,  $C_{OUT}=1\mu F$ ,  $V_{EN}=0V$ ,  $T_A=25^\circ C$ , test by G547F1, unless otherwise noted.)

Supply Current vs. Input Voltage



Shutdown Supply Current vs. Input Voltage

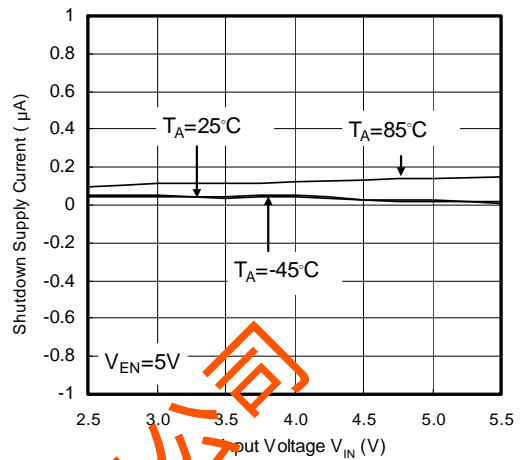

Enable Input Threshold vs. Input Voltage

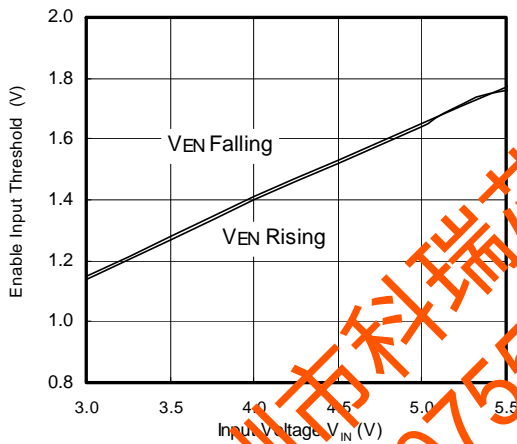

Enable Input Threshold vs. Temperature

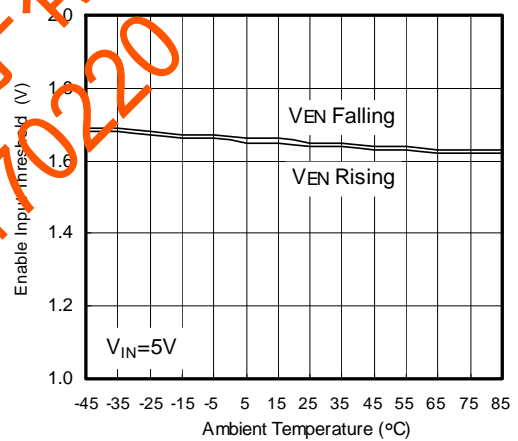

OC Deglitch Time vs. Input Voltage

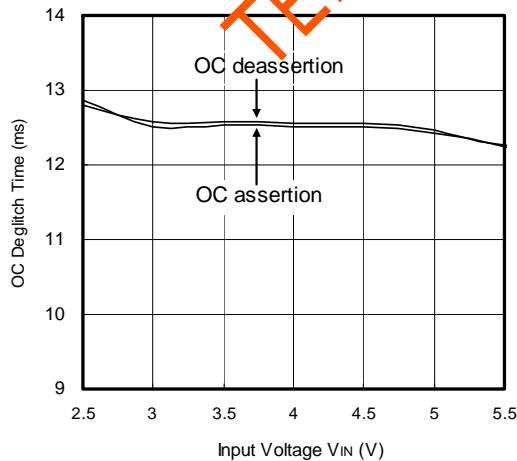

UVLO Threshold vs. Temperature

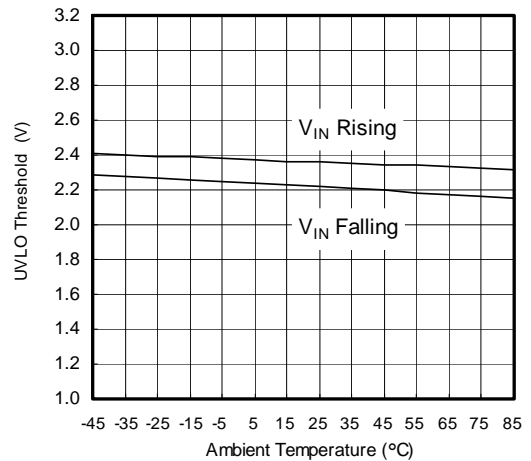

Typical Performance Characteristics (continued)

ON-Resistance vs. Input Voltage

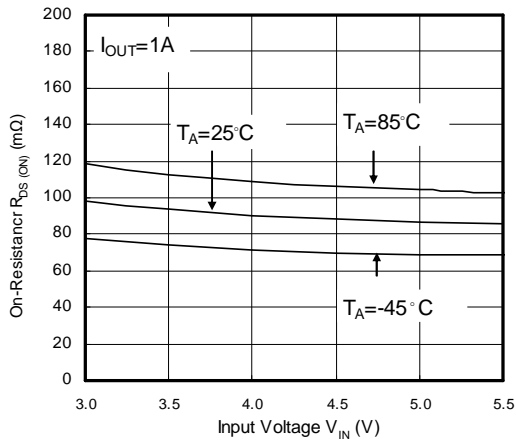

ON-Resistance vs. Temperature

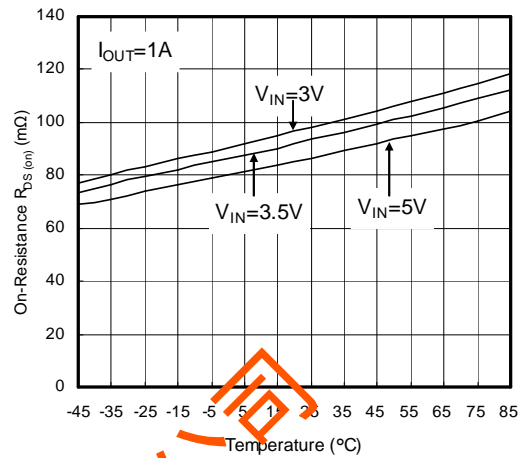

Current Limit Threshold vs. Input Voltage

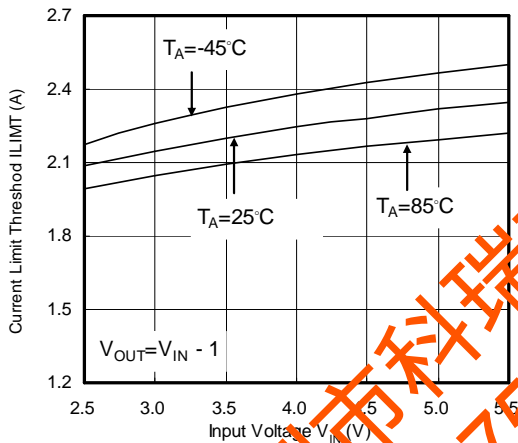

Short Circuit Current vs. Input Voltage

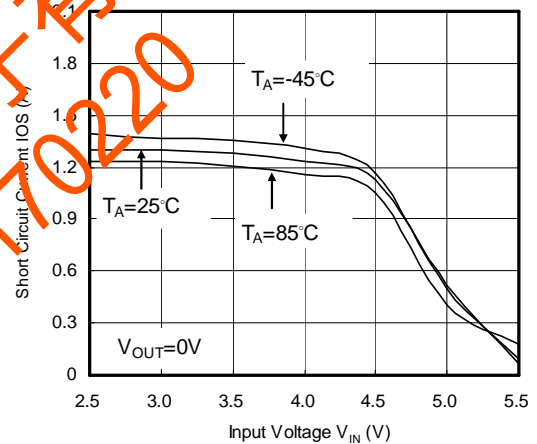

Overcurrent Protection Characteristics

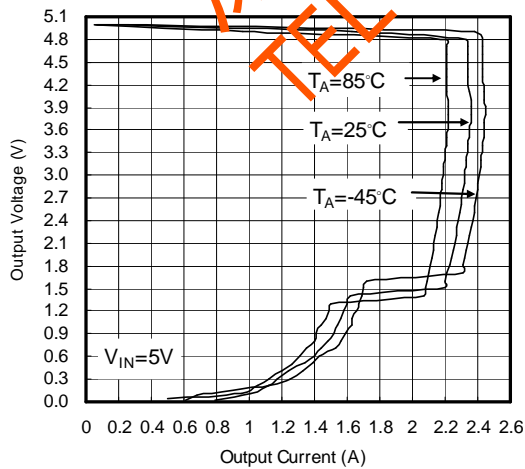

Overcurrent Protection Characteristics

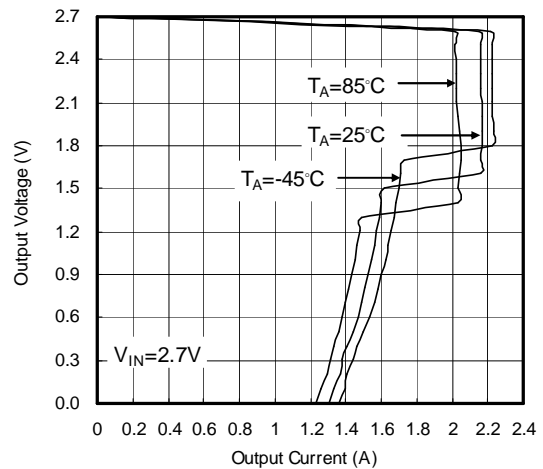

Typical Performance Characteristics (continued)

Turn on Delay Time and Rise Time

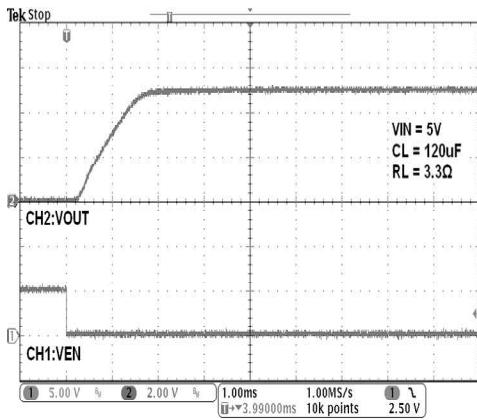

Turn off Delay Time and Fall Time

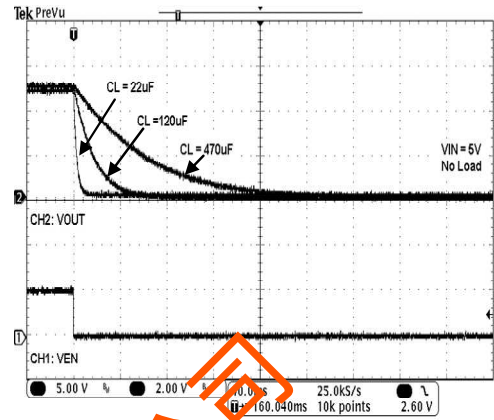

Inrush Current With Different Load Capacitance

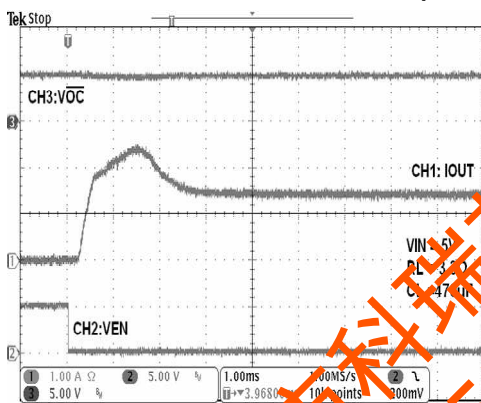

Thermal Shutdown Response

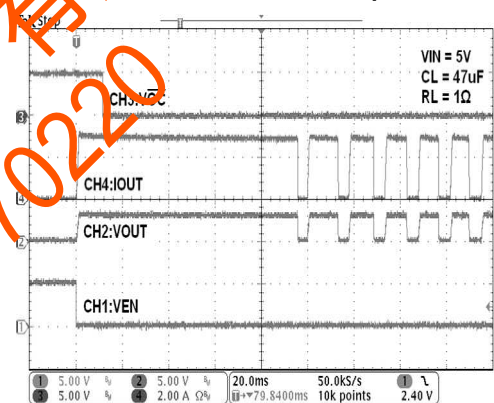

UVLO Protection at Rising

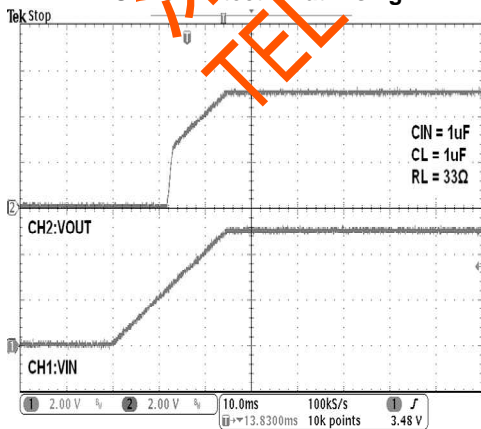

UVLO Protection at Falling

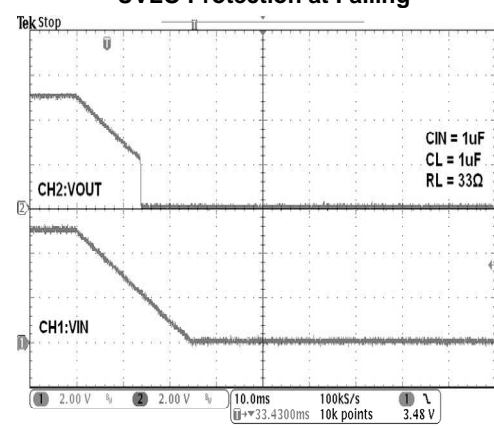

Typical Performance Characteristics (continued)

Inrush Short Circuit Response

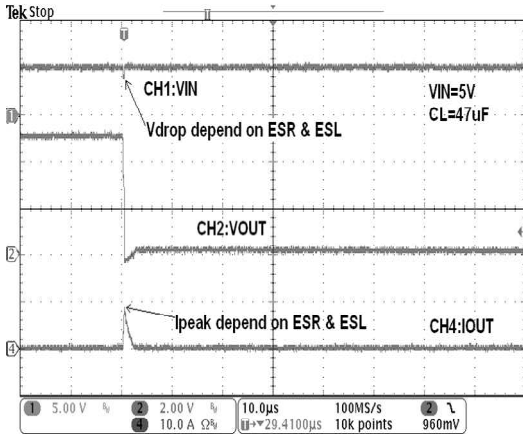

Short Circuit Response at Start up

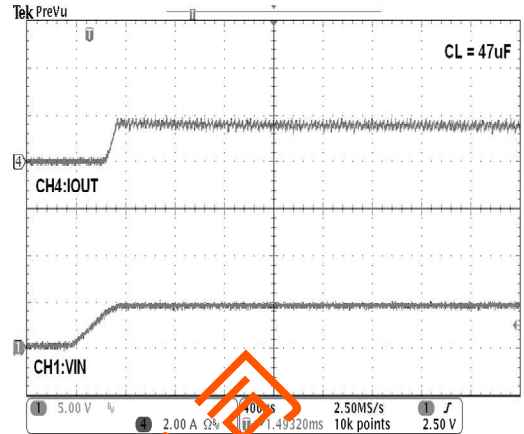

Short-Circuit Current, Device Enable into Short

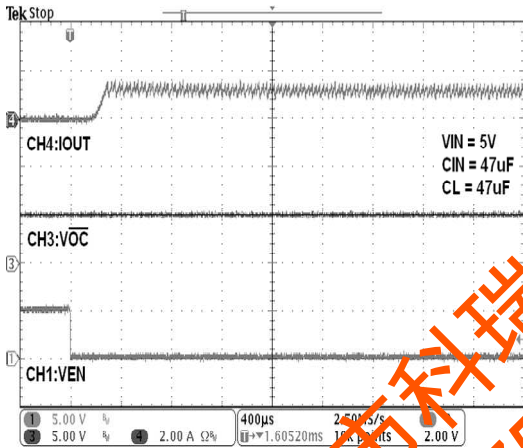

Resistance Load Inrush Response

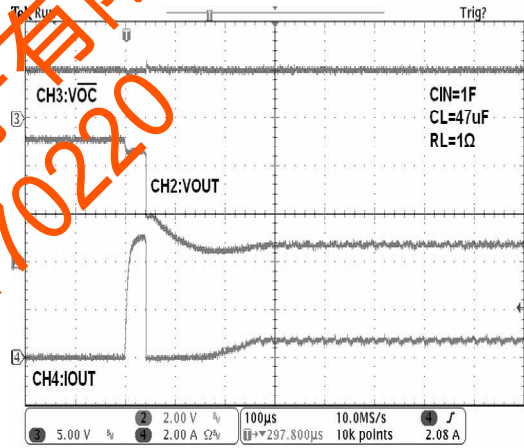

Capacitance Load Inrush Response

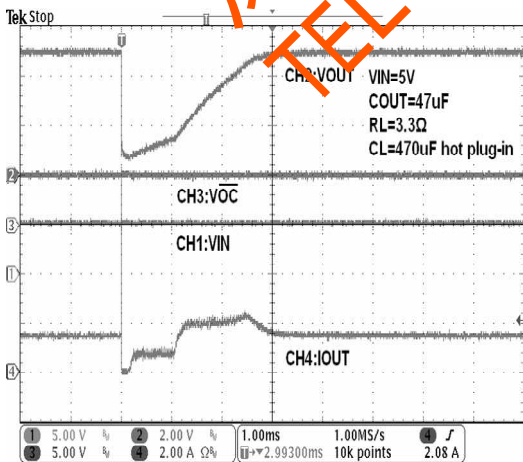

Capacitance Load Inrush Response

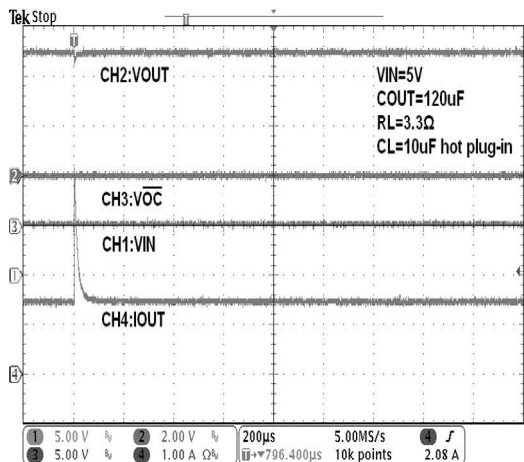

**Minimum Footprint PCB Layout Section**

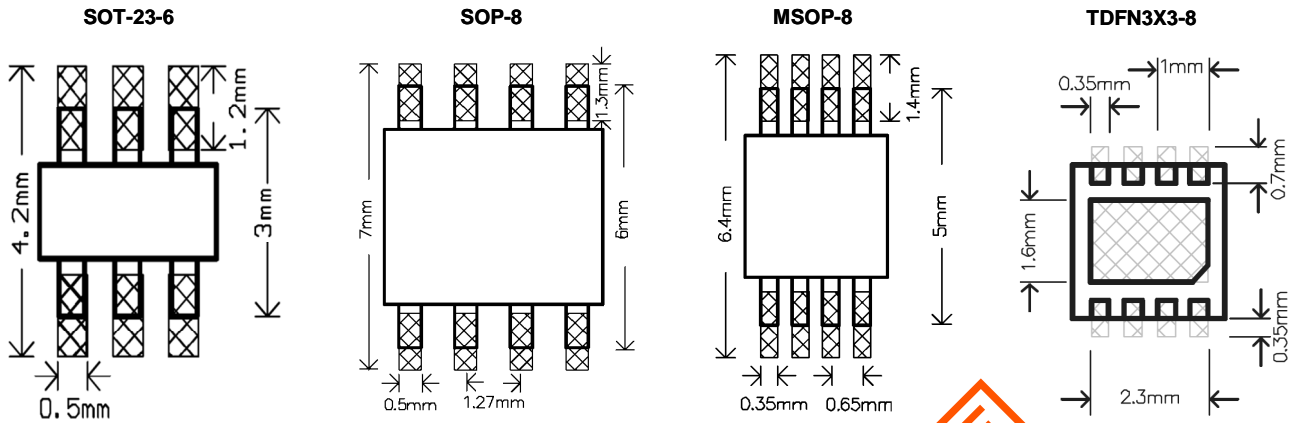

深圳市科瑞芯电子有限公司  
TEL: 0755-82170220



## Pin Description

| PIN      |              |             | NAME                         | PIN FUNCTION   |
|----------|--------------|-------------|------------------------------|--|
| SOT-23-6 | SOP-8/MSOP-8 | TDFN3X3-8   |                              |  |
| 2        | 1            | 1           | GND                          | <b>Ground</b>  |
| 3        | 2,3          | 2,3         | IN                           | <b>Input Supply:</b> Output MOSFET Drain, which also supplies IC's internal circuitry. Connect to positive supply. |
| 1        | 4            | 4           | EN( $\overline{\text{EN}}$ ) | <b>Enable:</b> Logic level enable input. Make sure EN pin never floating.  |
| 6        | 5            | 5           | $\overline{\text{OC}}$       | <b>Over-Current:</b> Open-Drain $\overline{\text{OC}}$ output.   |
| 4,5      | 6,7,8        | 6,7,8       | OUT                          | <b>Switch Output:</b> Output MOSFET Source of switch. Typically connect to switched side of load.                  |
|          |              | Thermal Pad |                              | Recommend connecting the Thermal Pad to the GND for excellent power dissipation.                                   |

## Block Diagram

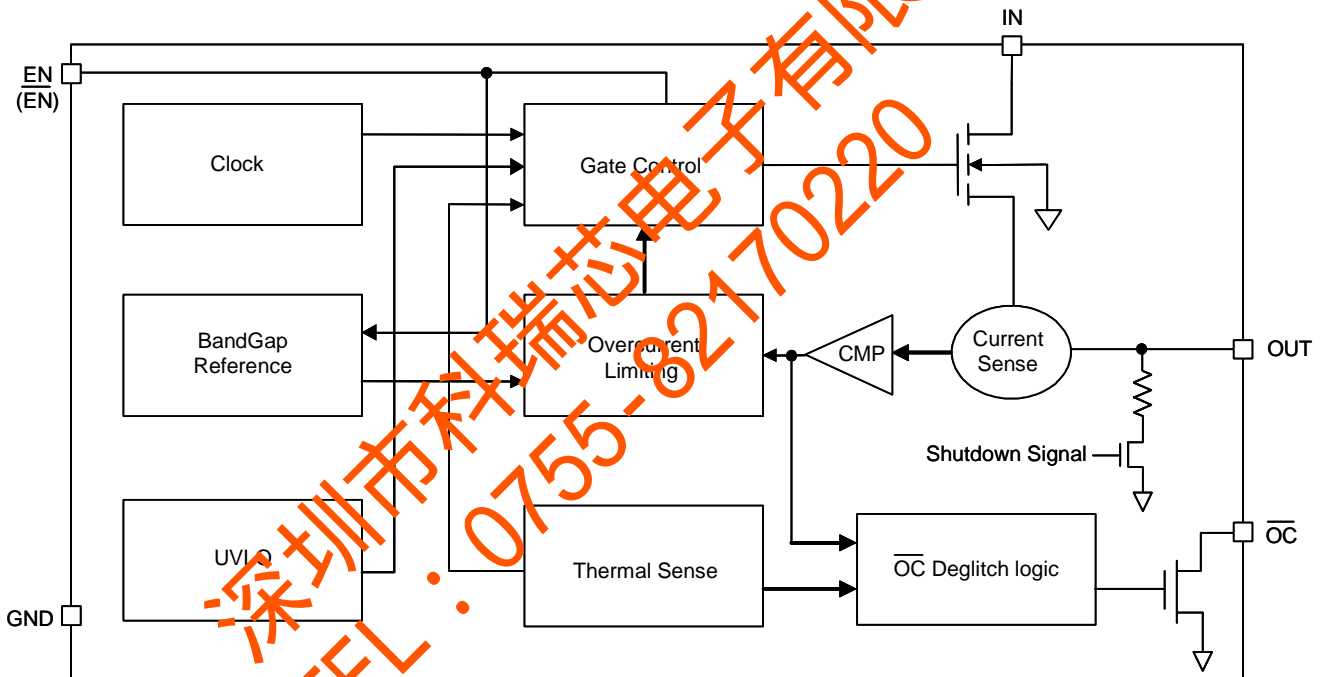

## Functional Description

### Input and Output

IN (input) is the power supply connection to the logic circuitry and the drain of the output MOSFET. OUT (output) is the source of the output MOSFET. In a typical application, current flows through the switch from IN to OUT toward the load. Both OUT pins must be connected together to the load.

### Thermal Shutdown

Thermal shutdown protects G547 from excessive power dissipation. If the die temperature exceeds 135°C, the MOSFETS switch is shut off. 20°C of hysteresis prevents the switch from turning on until the die temperature drops to 115°C. Thermal shutdown circuit functions only when the switch is enabled.

### Undervoltage Lockout

UVLO (undervoltage lockout) prevents the output MOSFET from turning on until IN (input voltage) exceeds 2.5V typically. After the switch turns on, if the voltage drops below 2.3V typically, UVLO shuts off the output MOSFET.

### Current Limiting

The typical current limit value of G547 is 3.7A, 2.5A, 2A, 1.5A, 1A. There is foldback of current limit when  $V_{OUT} < 1.5V$  (See Typical Performance Characteristics).

### $\overline{OC}$ Function

The  $\overline{OC}$  open-drain output is asserted (active low) when an over current or overtemperature shutdown condition is encountered after a 9-ms deglitch timeout. The output remains asserted until the overcurrent or overtemperature condition is removed.

## Applications Information

### Supply Filtering

A 1 $\mu$ F bypass capacitor from IN to GND, located near the G547, is strongly recommended to control supply transients. Without a bypass capacitor, an output short may cause sufficient ringing on the input (from supply lead inductance) to damage internal control circuitry.

Input transients must not exceed the absolute maximum supply voltage ( $V_{IN\ max} = 6V$ ) even for a short duration.

### EN, the Enable Input

EN must be driven logic high or logic low for a clearly defined input. Floating the input may cause unpredictable operation. EN should not be allowed to go negative with respect to GND.

深圳市科瑞芯电子有限公司  
TEL: 0755-82170220

**Test Circuit**

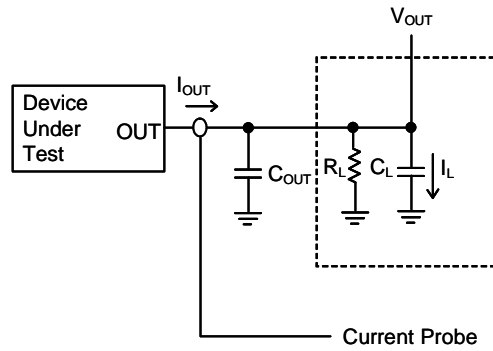

**Timing Diagrams**

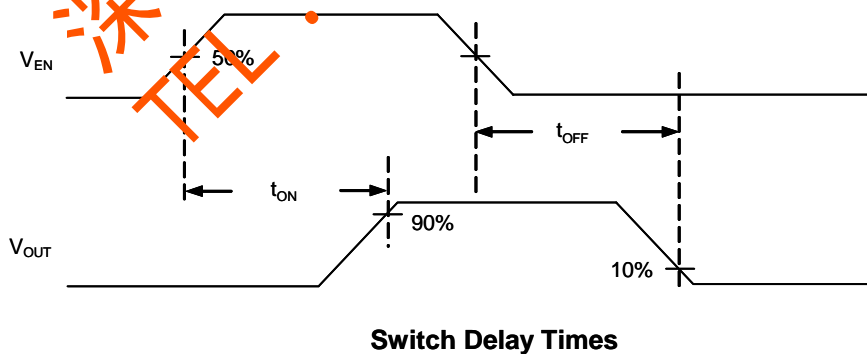
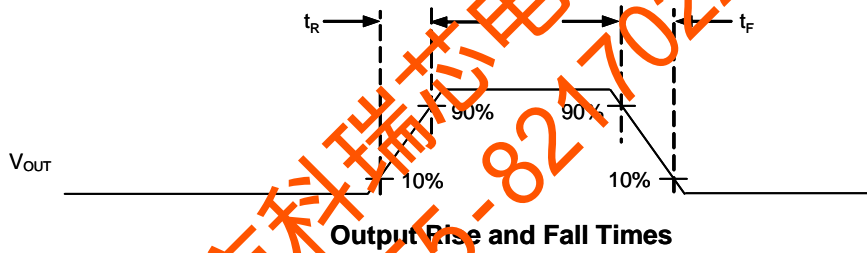

深圳市科瑞芯电子有限公司  
 TEL: 0755-82170220

## Package Information

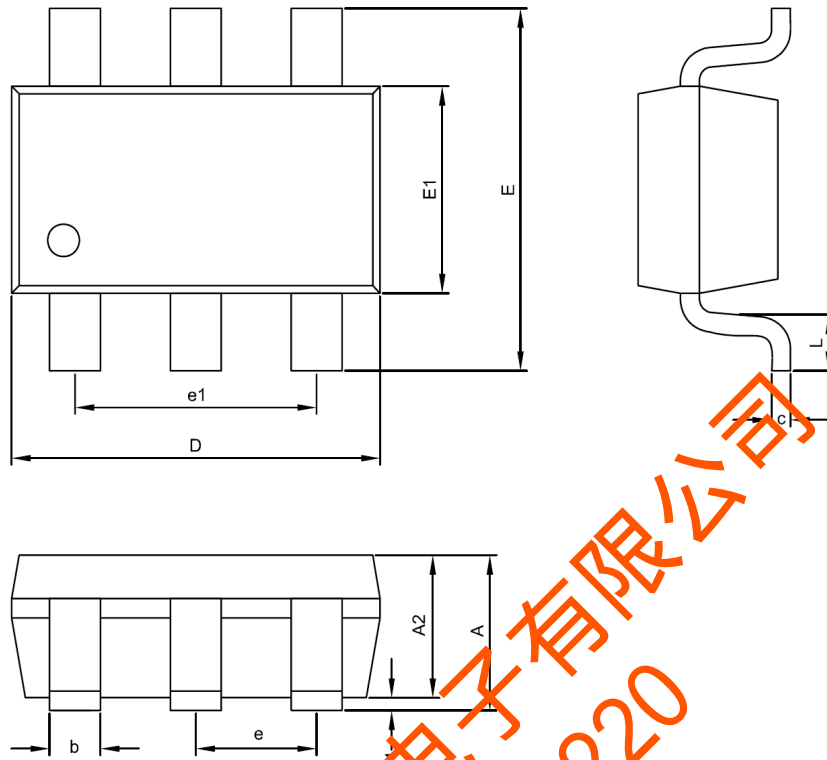

SOT-23-6 Package

| Symble | DIMENSION IN MM |      |      | DIMENSION IN INCH |       |       |
|--------|-----------------|------|------|-------------------|-------|-------|
|        | MIN.            | NOM. | MAX. | MIN.              | NOM.  | MAX.  |
| A      | 1.00            | 1.10 | 1.45 | 0.039             | 0.043 | 0.057 |
| A1     | 0.00            | ---  | 0.15 | 0.000             | ---   | 0.006 |
| A2     | 1.00            | 1.10 | 1.30 | 0.039             | 0.043 | 0.051 |
| D      | 2.70            | 2.90 | 3.10 | 0.106             | 0.114 | 0.122 |
| E      | 2.60            | 2.80 | 3.00 | 0.102             | 0.110 | 0.118 |
| E1     | 1.50            | 1.60 | 1.70 | 0.059             | 0.063 | 0.067 |
| c      | 0.08            | 0.15 | 0.25 | 0.003             | 0.006 | 0.010 |
| b      | 0.30            | 0.40 | 0.50 | 0.012             | 0.016 | 0.020 |
| e      | 0.95 BSC        |      |      | 0.037 BSC         |       |       |
| e1     | 1.90 BSC        |      |      | 0.075 BSC         |       |       |
| L      | 0.30            | 0.45 | 0.60 | 0.012             | 0.018 | 0.024 |

## Taping Specification

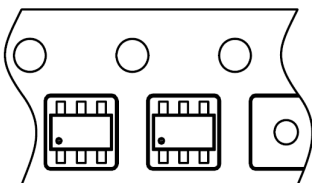

Feed Direction

| PACKAGE  | Q'TY/REEL |
|----------|-----------|
| SOT-23-6 | 3,000 ea  |

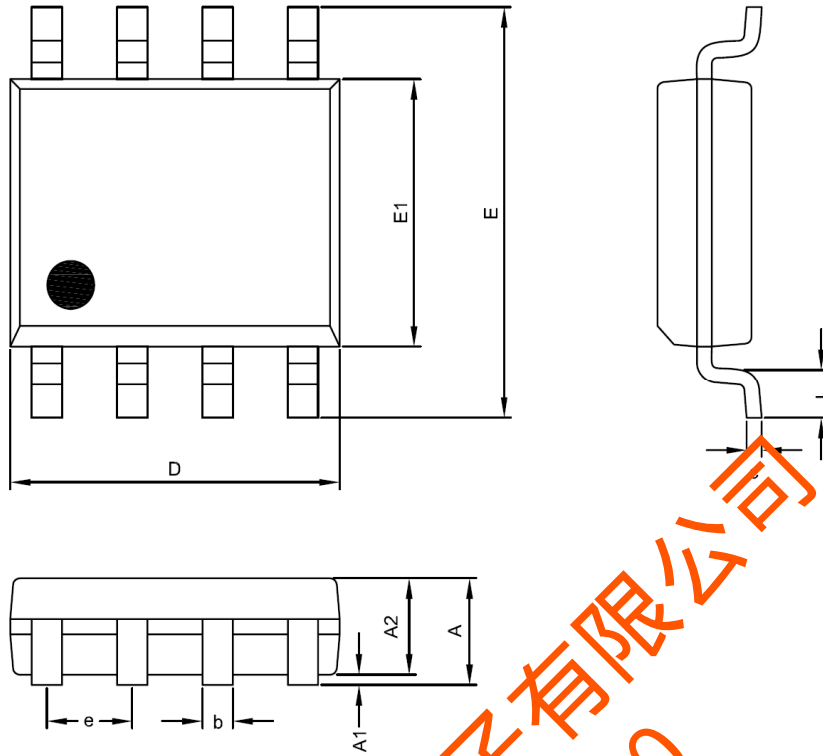

**SOP-8 Package**

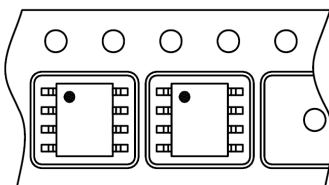
| Symble | DIMENSION IN MM |      |      | DIMENSION IN INCH |       |       |
|--------|-----------------|------|------|-------------------|-------|-------|
|        | MIN.            | NOM. | MAX. | MIN.              | NOM.  | MAX.  |
| A      | 1.35            | 1.55 | 1.75 | 0.053             | 0.061 | 0.069 |
| A1     | 0.00            | ---  | 0.25 | 0.000             | ---   | 0.010 |
| A2     | 1.15            | 1.35 | 1.50 | 0.045             | 0.053 | 0.059 |
| D      | 4.80            | 4.90 | 5.00 | 0.189             | 0.192 | 0.197 |
| E      | 5.80            | 6.00 | 6.20 | 0.228             | 0.236 | 0.244 |
| E1     | 3.80            | 3.90 | 4.00 | 0.150             | 0.153 | 0.157 |
| c      | 0.19            | 0.23 | 0.27 | 0.007             | 0.009 | 0.011 |
| b      | 0.23            | 0.43 | 0.53 | 0.013             | 0.017 | 0.021 |
| e      | 1.27 BSC        |      |      | 0.050 BSC         |       |       |
| L      | 0.40            | 0.7  | 1.00 | 0.016             | 0.028 | 0.039 |

**Taping Specification**

Feed Direction

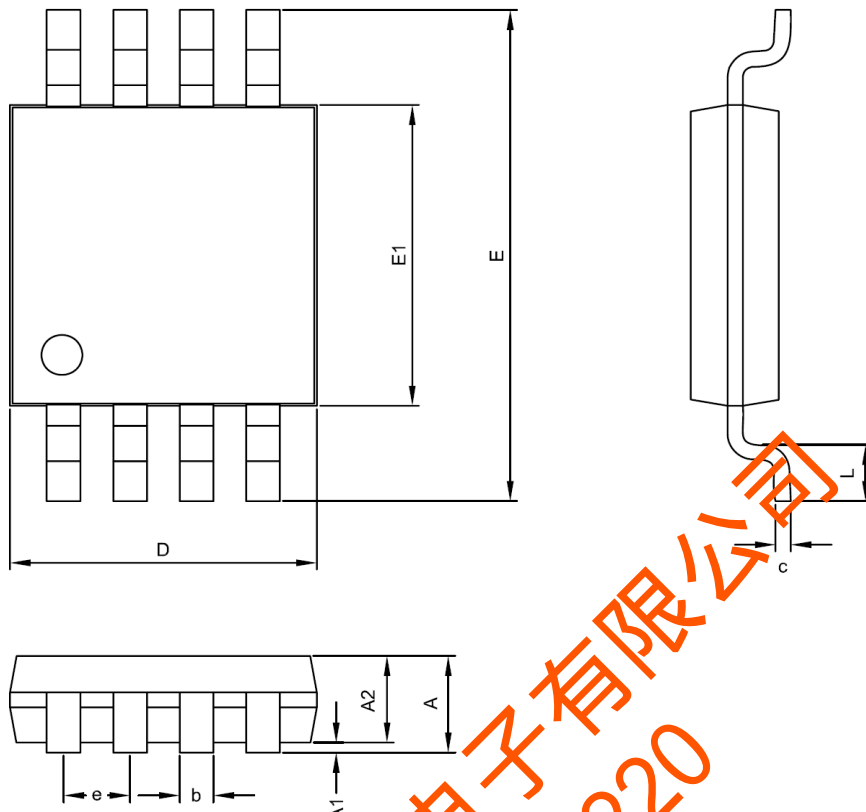
| PACKAGE | Q'TY/REEL |
|---------|-----------|
| SOP-8   | 2,500 ea  |



MSOP-8 Package

| Symble | DIMENSION IN MM |      |      | DIMENSION IN INCH |       |       |
|--------|-----------------|------|------|-------------------|-------|-------|
|        | MIN.            | NOM. | MAX. | MIN.              | NOM.  | MAX.  |
| A      | 0.81            | 0.86 | 1.00 | 0.032             | 0.037 | 0.043 |
| A1     | 0.00            | ---  | 0.15 | 0.000             | ---   | 0.006 |
| A2     | 0.76            | 0.86 | 0.96 | 0.030             | 0.034 | 0.038 |
| D      | 2.85            | 3.00 | 3.15 | 0.112             | 0.118 | 0.124 |
| E      | 4.75            | 4.90 | 5.05 | 0.187             | 0.193 | 0.199 |
| E1     | 2.85            | 3.00 | 3.15 | 0.112             | 0.118 | 0.124 |
| c      | 0.13            | 0.15 | 0.23 | 0.005             | 0.006 | 0.009 |
| b      | 0.28            | 0.30 | 0.38 | 0.011             | 0.012 | 0.015 |
| e      | 0.65 BSC        |      |      | 0.026 BSC         |       |       |
| L      | 0.4             | 0.53 | 0.8  | 0.016             | 0.021 | 0.031 |

**Taping Specification**

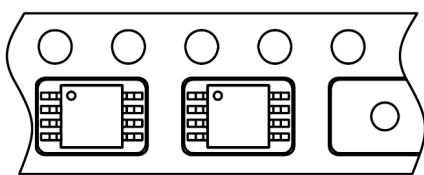

Feed Direction

| PACKAGE | Q'TY/REEL |
|---------|-----------|
| MSOP-8  | 3,000 ea  |

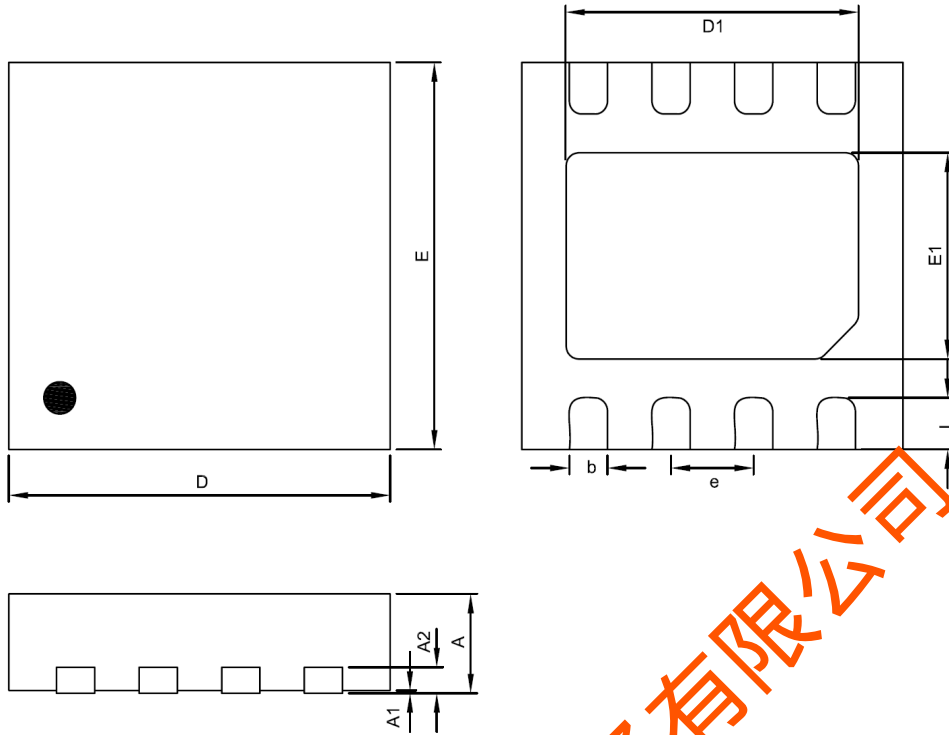
**TDFN3X3-8 Package**

| Symble | DIMENSION IN MM |      |      | DIMENSION IN INCH |        |        |
|--------|-----------------|------|------|-------------------|--------|--------|
|        | MIN.            | NOM. | MAX. | MIN.              | NOM.   | MAX.   |
| A      | 0.70            | 0.75 | 0.85 | 0.0276            | 0.0295 | 0.0315 |
| A1     | 0.00            | ---  | 0.05 | 0.0000            | ---    | 0.0020 |
| A2     | 0.19            | 0.20 | 0.21 | 0.0075            | 0.0079 | 0.0083 |
| D      | 2.95            | 3.00 | 3.05 | 0.1161            | 0.1181 | 0.1201 |
| E      | 2.95            | 3.00 | 3.05 | 0.1161            | 0.1181 | 0.1201 |
| D1     | 2.20            | 2.30 | 2.40 | 0.0866            | 0.0906 | 0.0945 |
| E1     | 1.40            | 1.50 | 1.60 | 0.0551            | 0.0591 | 0.0630 |
| b      | 0.25            | 0.30 | 0.35 | 0.0098            | 0.0118 | 0.0138 |
| e      | 0.65 BSC        |      |      | 0.0256 BSC        |        |        |
| L      | 0.30            | 0.35 | 0.45 | 0.0118            | 0.0138 | 0.0177 |

### Taping Specification

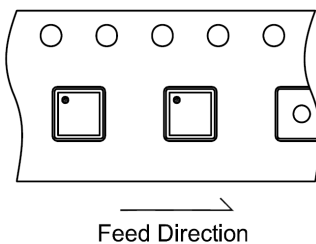

| PACKAGE   | Q'TY/REEL |
|-----------|-----------|
| TDFN3X3-8 | 3,000 ea  |

GMT Inc. does not assume any responsibility for use of any circuitry described, no circuit patent licenses are implied and GMT Inc. reserves the right at any time without notice to change said circuitry and specifications.

## X-ON Electronics

Largest Supplier of Electrical and Electronic Components

*Click to view similar products for* [Power Switch ICs - Power Distribution](#) *category:*

*Click to view products by* [Global Mixed-mode](#) *manufacturer:*

Other Similar products are found below :

[NCP45520IMNTWG-L](#) [TCK111G,LF\(S](#) [FPF1018](#) [DS1222](#) [TCK2065G,LF](#) [SZNCP3712ASNT3G](#) [TLE7244SL](#) [MIC2033-05BYMT-T5](#)  
[MIC2033-12AYMT-T5](#) [MIC2033-05BYM6-T5](#) [AP22811BW5-7](#) [SLG5NT1437VTR](#) [SZNCP3712ASNT1G](#) [DML1008LDS-7](#)  
[KTS1640QGDV-TR](#) [KTS1641QGDV-TR](#) [BTS500101TADATMA2](#) [NCV459MNWTBG](#) [NCP4545IMNTWG-L](#) [NCV8412ASTT1G](#)  
[NCV8412ASTT3G](#) [FPF2260ATMX](#) [SLG5NT1765V](#) [SLG5NT1757V](#) [SLG59M1557VTR](#) [BD2222G-GTR](#) [NCP45780IMN24RTWG](#)  
[NCP45540IMNTWG-L](#) [TPNTJD1155LT1G](#) [FDC6324L-TP](#) [FDC6326L-TP](#) [TPSI1869DH-T1-E3](#) [SI1865DDL](#) [FDC6330L-TP](#) [U6210](#)  
[U25135](#) [U62153](#) [U6513BS](#) [U62133](#) [U6773H](#) [U62143S](#) [U6315BS](#) [U6513B](#) [U6110](#) [SL3405S](#) [BTS7040-2EPA](#) [SY6282ACC](#) [WS3222D-](#)  
[8/TR](#) [DP25136C](#) [DK5V100R20C](#)