

Buck Chopper with Field Stop Trench IGBT + SiC SBD

$V_{CES} = 1200V$
 $I_C = 80A @ T_C = 100^{\circ}C$



Features

- **Field StopTrench Fast IGBT**
 - Low voltage drop
 - Low tail current
 - Switching frequency up to 50 kHz
 - Low leakage current
- **Chopper SiC Schottky Diode**
 - Zero reverse recovery current
 - Temperature Independent switching behavior
 - Positive temperature coefficient on VF

Applications

- Solar inverters
- AC and DC motor control
- Power Factor Correction
- Aerospace Actuators



Benefits

- Outstanding performance at high frequency operation
- Low switching losses
- Very rugged
- Direct mounting to heatsink (isolated package)
- Low junction to case thermal resistance
- Easy paralleling due to positive T_C of V_{CESat}
- RoHS Compliant

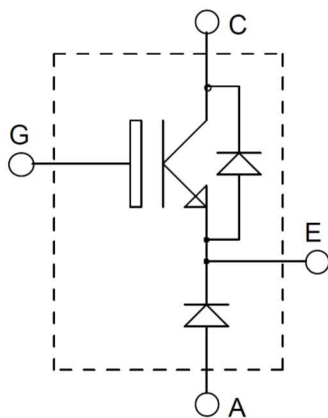

Absolute Maximum Ratings ($T_J=25^{\circ}C$ unless otherwise specified)

Parameters	Symbol	Conditions	Specifications	Units
Collector - Emitter Breakdown Voltage	V_{CES}		1200	V
Continuous Collector Current	I_C	$T_C = 25^{\circ}C$	160	A
		$T_C = 100^{\circ}C$	80	A
Gate-Emitter Voltage	V_{GES}		± 20	V
Pulsed Collector Current	ICM		240	A
Maximum Power Dissipation	P_D	$T_C = 25^{\circ}C$	480	W
		$T_C = 100^{\circ}C$	200	W
Operating Junction Temperature	T_J		-55 ~ 150	$^{\circ}C$
Storage Temperature	T_{STG}		-55 ~ 150	$^{\circ}C$

Electrical Characteristics ($T_J=25^{\circ}\text{C}$ unless otherwise specified)

Parameters	Symbol	Conditions	Min	Typ	Max	Units
OFF						
Zero Gate Voltage Collector Current	I_{CES}	$V_{CE} = 1200\text{V}, V_{GE} = 0\text{V}$	--	--	2	mA
Gate-Emitter Leakage Current	I_{GES}	$V_{CE} = 0\text{V}, V_{GE} = 20\text{V}$	--	--	± 500	nA
ON						
Gate-Emitter Threshold Voltage	$V_{GE(TH)}$	$V_{GE} = V_{CE}, I_C = 80\text{mA}$	4.5	6.5	8.5	V
Collector-Emitter Saturation Voltage	$V_{CE(SAT)}$	$V_{CE} = 15\text{V}, I_C = 80\text{A}, T_J = 25^{\circ}\text{C}$	--	2.0	2.6	V
		$V_{CE} = 15\text{V}, I_C = 80\text{A}, T_J = 125^{\circ}\text{C}$	--	2.45	--	V
DYNAMIC						
Input Capacitance	C_{IES}	$V_{CE} = 30\text{V}, V_{GE} = 0\text{V}, f = 1\text{MHz}$	--	10.3	--	nF
Output Capacitance	C_{OES}		--	300	--	pF
Reverse Transfer Capacitance	C_{RES}		--	200	--	pF
SWITCHING						
Turn-On Delay Time	$t_{d(on)}$	$V_{CE} = 600\text{V}, I_C = 80\text{A}$ $R_G = 10\Omega, V_{GE} = 15\text{V}$ Inductive Load, $T_J = 25^{\circ}\text{C}$	--	60	--	ns
Rise Time	t_r		--	85	--	ns
Turn-Off Delay Time	$t_{d(off)}$		--	200	--	ns
Fall Time	t_f		--	60	--	ns
Turn-On Switching Energy Loss	E_{ON}		--	7.1	--	mJ
Turn-Off Switching Energy Loss	E_{OFF}		--	1.2	--	mJ
Turn-On Delay Time	$t_{d(on)}$	$V_{CE} = 600\text{V}, I_C = 80\text{A}$ $R_G = 10\Omega, V_{GE} = 15\text{V}$ Inductive Load, $T_J = 125^{\circ}\text{C}$	--	50	--	ns
Rise Time	t_r		--	80	--	ns
Turn-Off Delay Time	$t_{d(off)}$		--	210	--	ns
Fall Time	t_f		--	120	--	ns
Turn-On Switching Energy Loss	E_{ON}		--	7.6	--	mJ
Turn-Off Switching Energy Loss	E_{OFF}		--	2.4	--	mJ
Total Gate Charge	Q_g	$V_{CE} = 600\text{V}, I_C = 80\text{A}$ $V_{GE} = 15\text{V}$	--	640	960	nC
Gate-Emitter Charge	Q_{ge}		--	80	120	nC
Gate-Collector Charge	Q_{gc}		--	300	450	nC
Short Circuit Withstanding Time	t_{sc}	$V_{CE} = 600\text{V}, V_{GE} = 15\text{V}$ $T_J = 125^{\circ}\text{C}$	--	--	10	μs

SiC Diode Rating and Characteristics (T_j=25°C unless otherwise specified)

Parameters	Symbol	Conditions	Min	Typ	Max	Units
Maximum peak repetitive reverse voltage	V _{RRM}		1200	--	--	V
Maximum Reverse Leakage Current	I _{RM}	V _R = 1200V, T _j = 25 °C	--	20	200	μA
		V _R = 1200V, T _j = 150 °C	--	2424	--	μA
Diode Forward Voltage	V _F	I _F = 40A, T _j = 25 °C	--	1.5	1.7	V
		I _F = 40A, T _j = 150 °C	--	2.3	--	V
Total Capacitive Charge	Q _C	V _R =1200 V, I _F <I _{F,max}	--	208	--	nC
Switching Time	t _C	di _F /dt = 200 A/μs, T _j = 175 °C	--	--	20	ns
Total Capacitance	C	V _R = 1V, f = 1 MHz	--	3600	--	pF
		V _R = 600V, f = 1 MHz	--	228	--	pF
		V _R = 1200V, f = 1 MHz	--	172	--	pF

Thermal and Package Characteristics (T_j=25°C unless otherwise specified)

Parameters	Symbol	Conditions	Min	Typ	Max	Units
Junction to Case Thermal Resistance	R _{THJC}	IGBT chip	--	--	0.26	°C/W
		SiC SBD chip	--	--	0.49	°C/W
Mounting Torque	M _d				1.5	N-m
Terminal Connection Torque	M _{dt}		1.3	--	1.5	N-m
Package Weight	W _t			29		g
Isolation Voltage	V _{ISOL}	I _{ISOL} < 1mA, 50/60 Hz, t=1 min	2500	V		

IGBT Characteristics (2*40A dies in parallel)

Fig. 1 Output characteristics

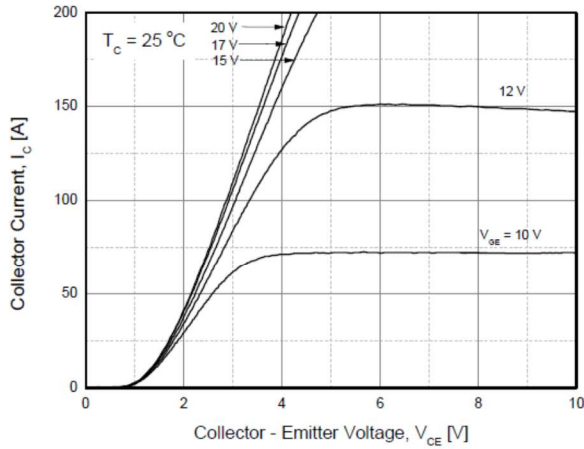

Fig. 2 Saturation voltage characteristics

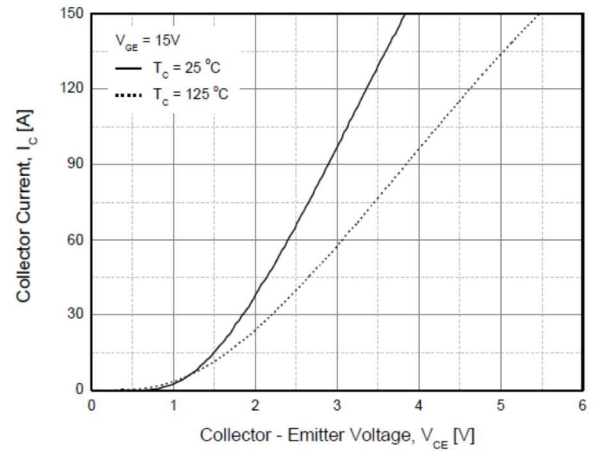

Fig. 3 Saturation voltage vs. collector current

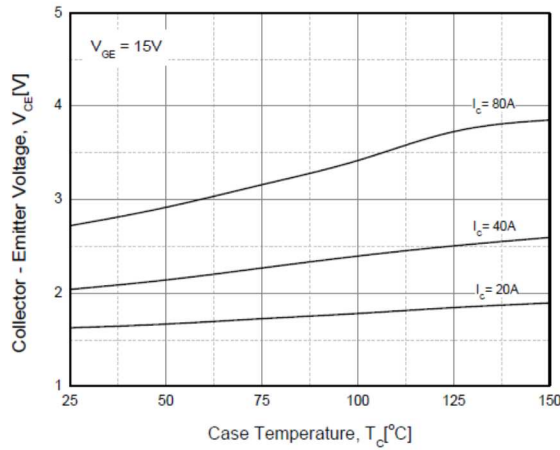

Fig. 4 Saturation voltage vs. gate bias

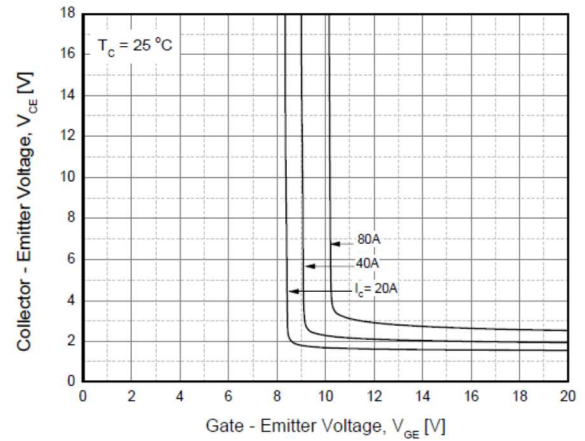

Fig. 5 Saturation voltage vs. gate bias

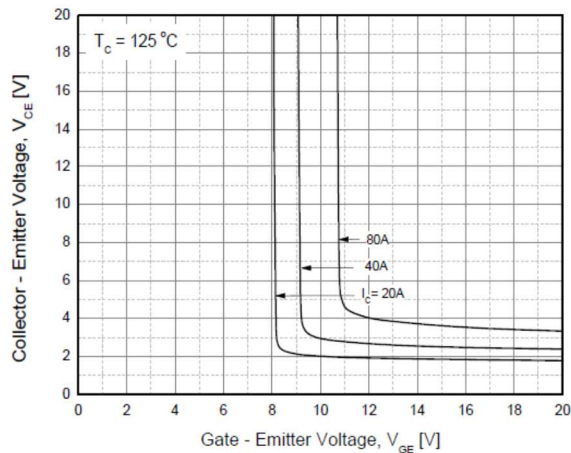

Fig. 6 Capacitance characteristics

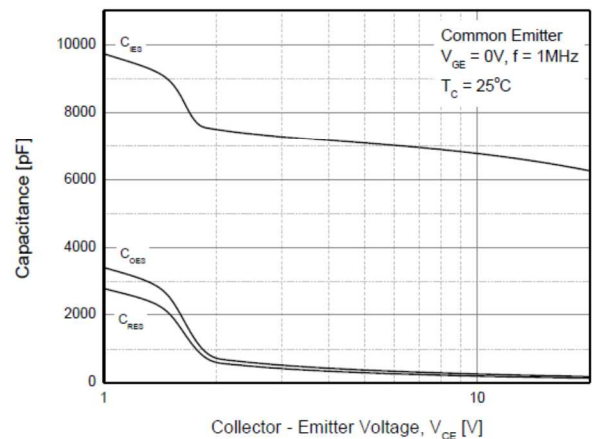

Fig. 7 Turn-on time vs. gate resistor

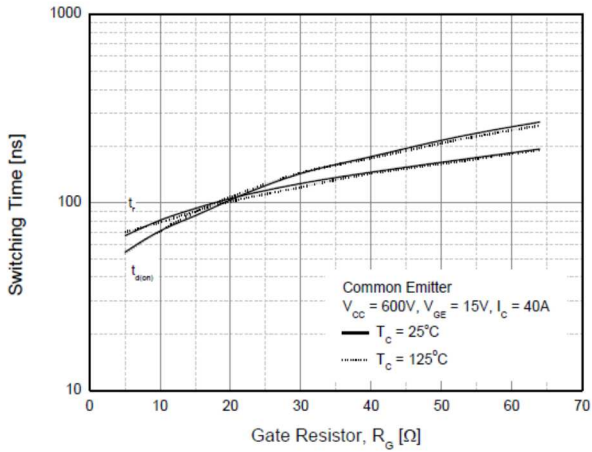

Fig. 8 Turn-off time vs. gate resistor

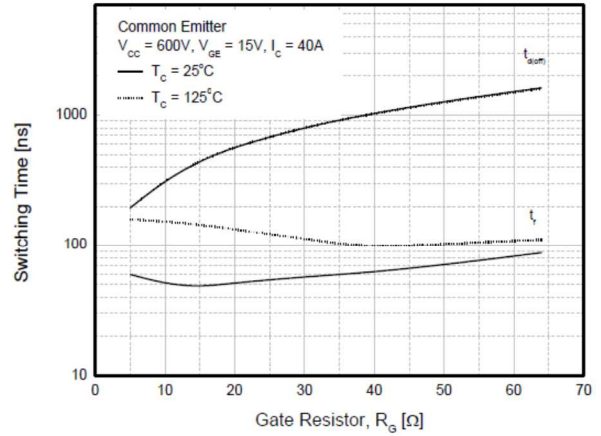

Fig. 9 Switching loss vs. gate resistor

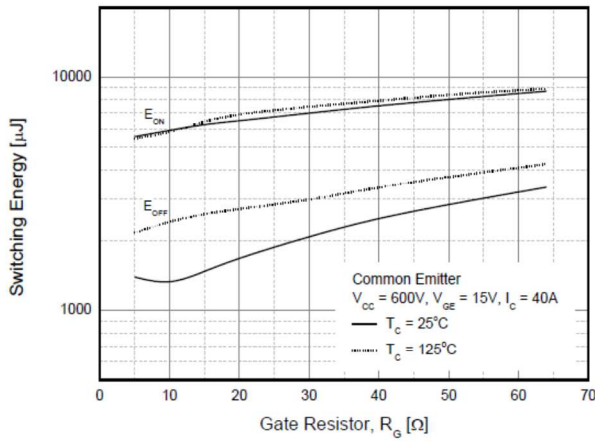

Fig. 10 Turn-on time vs. collector current

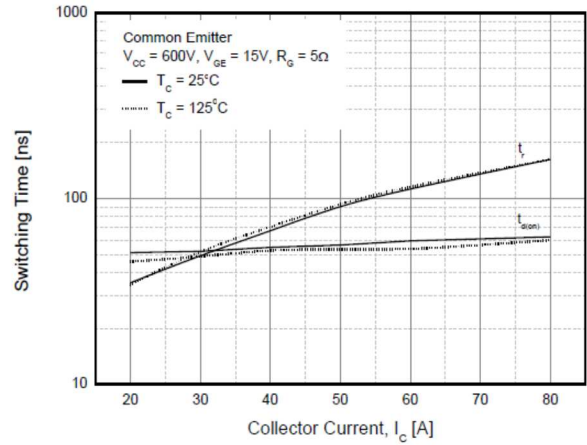

Fig. 11 Turn-off time vs. collector current

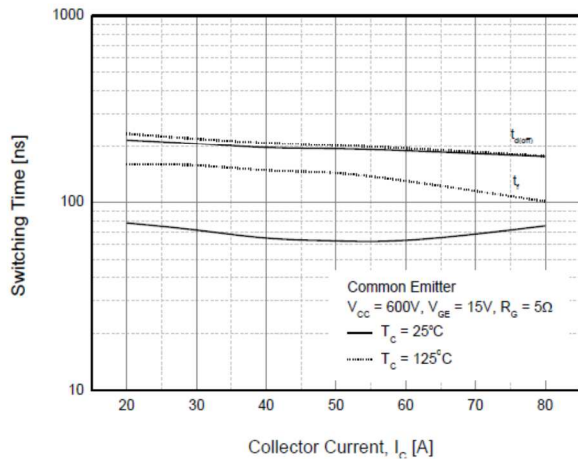

Fig. 12 Switching loss vs. collector current

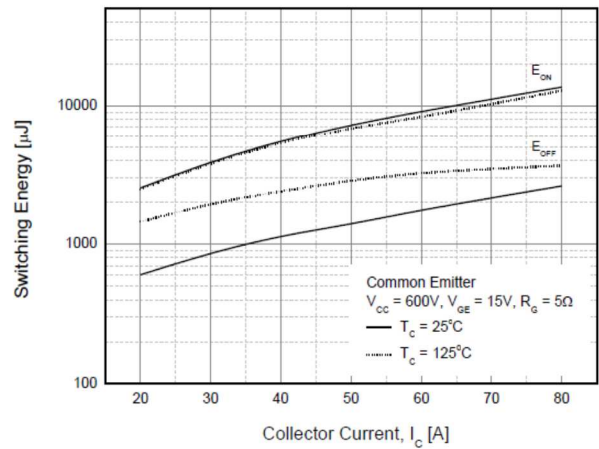

Fig. 13 Gate charge characteristics

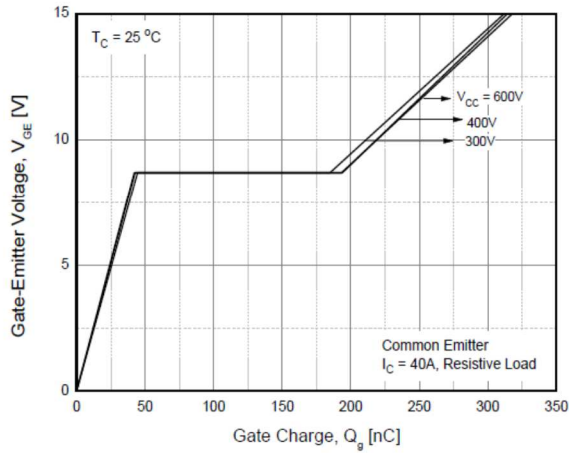

Fig. 14 SOA

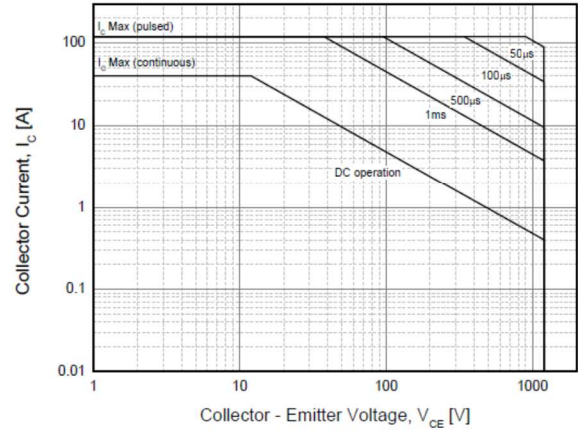

Fig. 15 RBSOA

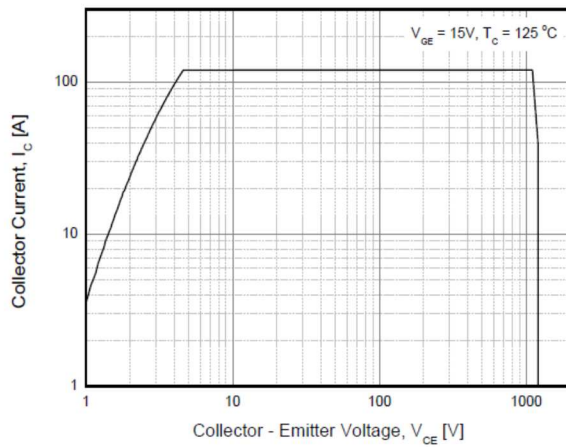
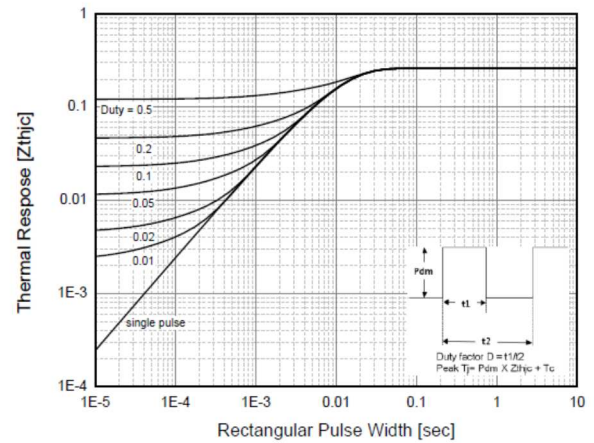

Fig. 16 Transient thermal impedance of IGBT



Buck SiC Diode Characteristics (2*20A dies in parallel)

Fig. 17 Forward Characteristics

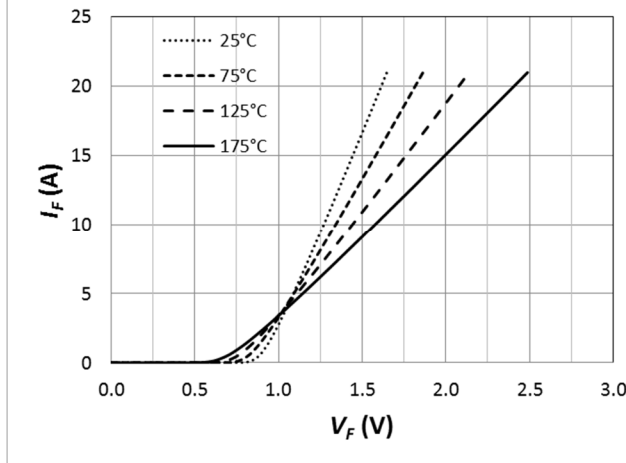

Fig. 18 Reverse Characteristics

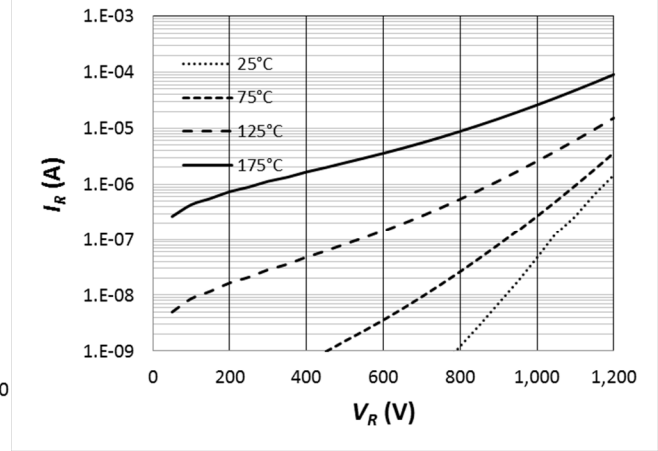

Fig. 19 Power Derating

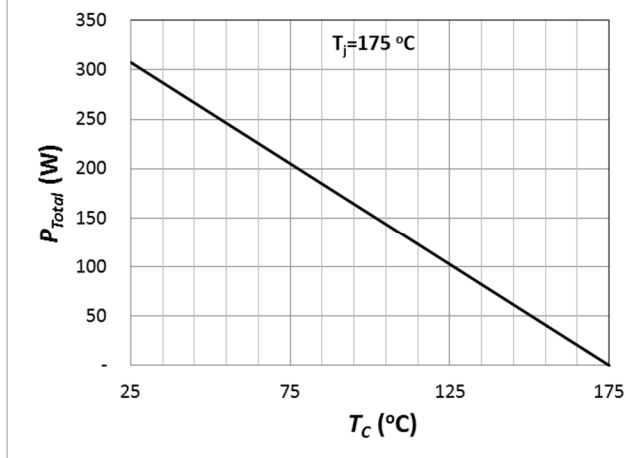

Fig. 20 Current Derating

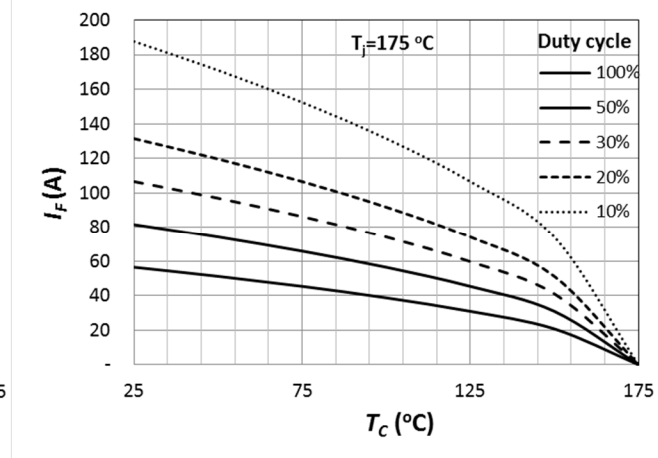

Fig. 21 Capacitance Curve

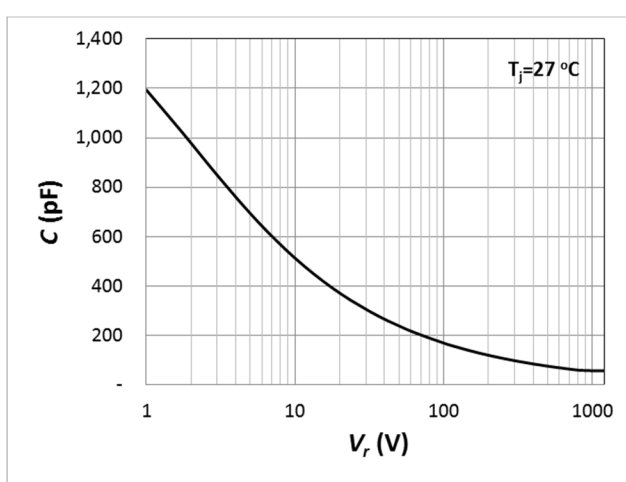
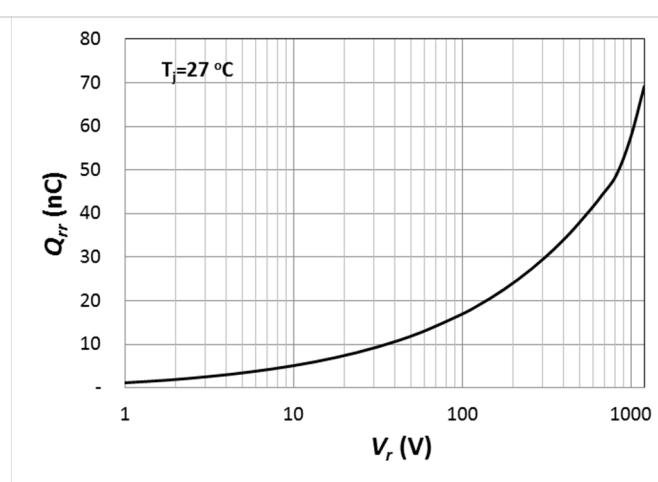
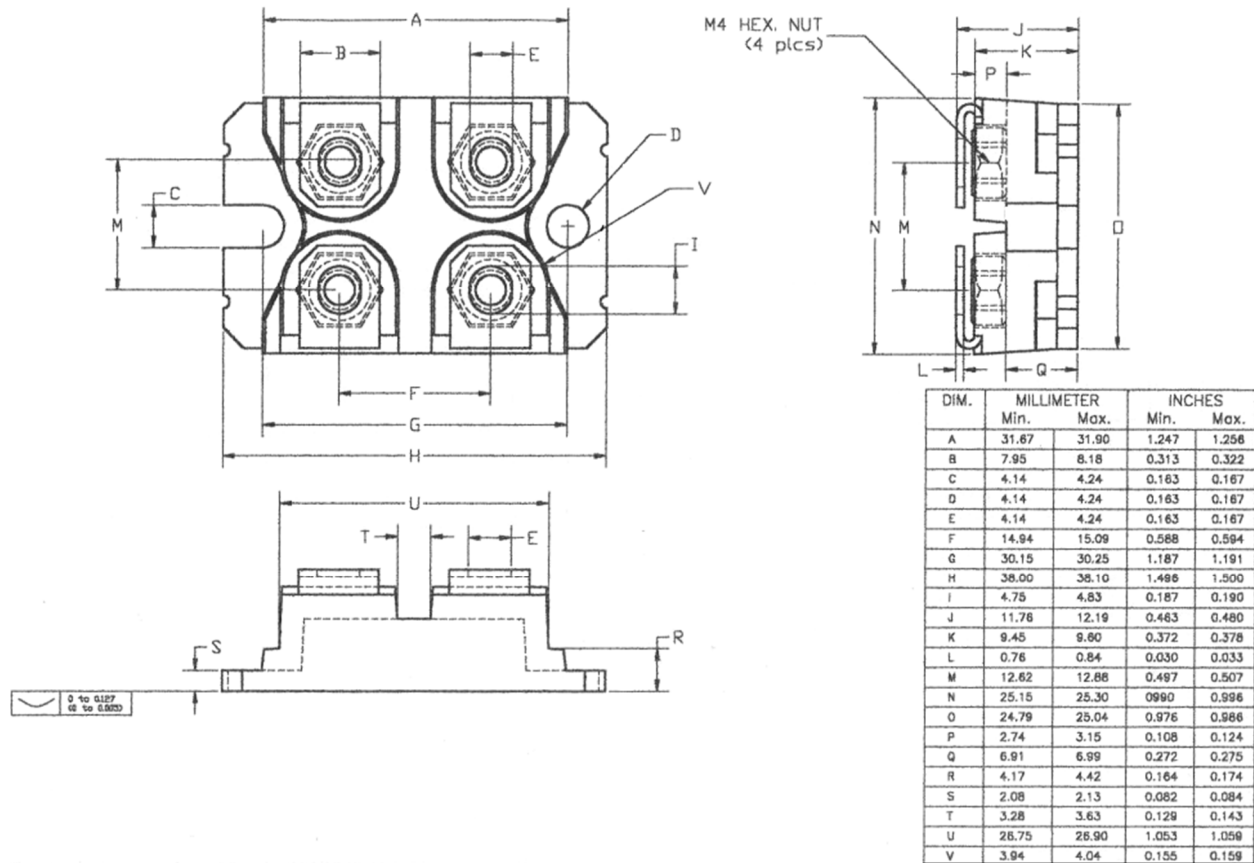

Fig. 22 Recovery Charge



SOT-227 Package Outline



Revision History

Date	Revision	Notes
6/3/2014	1.0	Initial release
8/2/2018	1.1	Correct the typo in the pin assignment

To obtain additional technical information or to place an order for this product, please contact us. The information in this datasheet is provided by Global Power Electronics, Inc. GPE reserves the right to make changes, corrections, modifications, and improvements without notice.

Global Power Technologies Group

20692 Prism Place
 Lake Forest, CA 92630
 TEL (949) 207-7500
 FAX (949) 613-7600
 E-mail: info@gptechgroup.com
 Web site: www.gptechgroup.com



X-ON Electronics

Largest Supplier of Electrical and Electronic Components

Click to view similar products for [global power technologies manufacturer](#):

Other Similar products are found below :

[GSID300A120S5C1](#)