

## Ultra Low Quiescent Current, Hysteretic DC-DC Boost Converter

### Features

- 0.7V ~ 5.0V input voltage operation
- 2.2V ~ 5.0V fixed output voltage
- 200mA maximum output current load
- 1µA ultra low quiescent current
- Shutdown current < 100nA
- 94% efficiency
- Output true-shutdown.
- Auto-bypass mode when  $V_{IN} > V_{OUT}$
- Adjustable low battery detection or Power-Good output selectable
- Over temperature protection
- No external diode or transistor required
- TDFN2X2-8 Package

### Applications

Handheld devices

### General Description

The G5390 is an ultra low quiescent current, hysteretic DC-DC boost converter. The device can operate from a 0.7V to 5.0V supply and the output voltage is fixed from 2.2V to 5.0V. The output is not connected to the input in shutdown mode and the shutdown current is less than 100nA. The G5390 features auto-bypass mode when the device directly connect the input to the output voltage if the  $V_{IN}$  exceeds  $V_{OUT}$ . In light load operation, the G5390 enters sleep mode. Most of the operating blocks are turned off for saving power. The G5390 also offers adjustable low battery detection. The LBO output is pulled to logic low if the battery voltage decreases below the threshold defined by external resistors on pin LBI. Alternately, the LBO output is working as Power-Good function when LBI is connected to GND.

### Ordering Information

ORDER NUMBER	MARKING	VOLTAGE	TEMP. RANGE	PACKAGE (Green)
G5390-33RC1U	530A	3.3V	-40°C~+85°C	TDFN2X2-8
G5390-50RC1U	530B	5.0V	-40°C~+85°C	TDFN2X2-8
G5390-45RC1U	530C	4.5V	-40°C~+85°C	TDFN2X2-8
G5390-30RC1U	530D	3.0V	-40°C~+85°C	TDFN2X2-8
G5390-28RC1U	530E	2.8V	-40°C~+85°C	TDFN2X2-8
G5390-25RC1U	530F	2.5V	-40°C~+85°C	TDFN2X2-8
G5390-23RC1U	530G	2.3V	-40°C~+85°C	TDFN2X2-8
G5390-22RC1U	530H	2.2V	-40°C~+85°C	TDFN2X2-8

Note: RC: TDFN2X2-8

1: Bonding code

D & U: Tape & Reel

Green: Lead Free / Halogen Free

### Pin Configuration

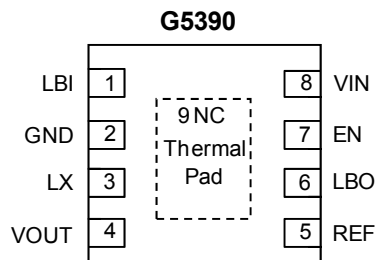

**TDFN2X2-8**

\*This pad can be left floating or connect to GND for an optimal thermal performance.

## Absolute Maximum Ratings

V <sub>IN</sub> , V <sub>OUT</sub> . . . . .	-0.3V to +6.5V
LX, REF . . . . .	-0.3V to (V <sub>OUT</sub> +0.3)V
EN, LBI, LBO . . . . .	-0.3V to +6.3V
Thermal Resistance Junction to Ambient, (θ <sub>JA</sub> )	
TDFN2X2-8. . . . .	.60°C/W
Continuous Power Dissipation (T <sub>A</sub> =+25°C)	
TDFN2X2-8 . . . . .	0.5W

Operating Junction Temperature . . . . .	+150°C
Storage Temperature range . . . . .	-55°C to +150°C
Reflow Temperature (Soldering, 10sec) . . . . .	.260°C
ESD Susceptibility (HBM). . . . .	.2kV
ESD Susceptibility (MM). . . . .	.300V

\* The package is placed on a 2-layer PCB (1oz).

1. Stresses beyond those listed under “Absolute Maximum Ratings” may cause permanent damage to the device. These are stress ratings only, and functional operation of the device at these or any other conditions beyond those indicated in the operational sections of the specifications are not implied. Exposure to absolute maximum rating conditions for extended periods may affect device reliability.
2. Device is ESD sensitive. Handling precaution recommended. The Human Body model is a 100pF capacitor discharged through a 1.5KΩ resistor into each pin.

## Electrical characteristics

(V<sub>IN</sub>=1.5V, T<sub>A</sub>=25°C.)

The device is not guaranteed to function outside its operating conditions. Parameters with MIN and/or MAX limits are 100% tested at +25°C, unless otherwise specified.

PARAMETER	SYMBOL	CONDITIONS	MIN	TYP	MAX	UNIT
Input Voltage Range	V <sub>IN</sub>		0.7	---	5.0	V
Minimum Startup Voltage	V <sub>IN_START</sub>	T <sub>AMB</sub> =+25°C	---	0.7	---	V
Output Voltage Range	V <sub>OUT</sub>		2.2	---	5.0	V
Output Lockout Threshold	V <sub>OUT_LO</sub>	V <sub>OUT</sub> rising	---	2	---	V
Output Lockout Threshold Hysteresis	ΔV <sub>OUT_LO</sub>	V <sub>OUT</sub> falling	---	100	---	mV
Reference Voltage	V <sub>REF</sub>		0.99	1	1.01	V
Output Voltage Tolerance		I <sub>LOAD</sub> =0mA to 10mA, T <sub>AMB</sub> =+25°C	-2	---	+2	%
Quiescent Current at V <sub>IN</sub>	I <sub>Q_IN</sub>	V <sub>OUT</sub> =1.02xV <sub>OUTNOM</sub> , T <sub>AMB</sub> =+25°C	---	---	100	nA
Quiescent Current at V <sub>OUT</sub>	I <sub>Q_OUT</sub>	V <sub>OUT</sub> =5V, No load, T <sub>AMB</sub> =+25°C	0.7	1	1.3	μA
Shutdown Current	I <sub>SD</sub>	T <sub>AMB</sub> =+25°C	---	---	100	nA
PMOS ON Resistance	R <sub>ON_P</sub>	V <sub>OUT</sub> =5V	---	0.45	---	Ω
NMOS ON Resistance	R <sub>ON_N</sub>	V <sub>OUT</sub> =5V	---	0.4	---	Ω
NMOS Maximum On-Time	T <sub>ON_MAX</sub>		3.3	4.0	4.6	μs
Peak Current Limit	I <sub>PEAK</sub>		---	400	---	mA
Zero Crossing Current	I <sub>ZC</sub>		5	20	35	mA
EN input voltage HIGH	V <sub>IH</sub>		0.7	---	---	V
EN input voltage LOW	V <sub>IL</sub>		---	---	0.1	V
EN input current	I <sub>EN</sub>	EN=5V, T <sub>AMB</sub> =+25°C	---	---	100	nA
REF input current	I <sub>REF</sub>	REF=1.01V, T <sub>AMB</sub> =+25°C	---	---	100	nA
LBI threshold	V <sub>LBI</sub>	LBI falling	0.57	0.6	0.63	V
LBI hysteresis	V <sub>LBI_HYS</sub>	LBI rising	---	25	---	mV
LBI leakage current	I <sub>LBI</sub>	LBI =1.5V, T <sub>AMB</sub> =+25°C	---	---	100	nA
LBO voltage low	V <sub>LBO</sub>	I <sub>LBO</sub> =1mA	---	5	20	mV
LBO leakage current	I <sub>LBO</sub>	T <sub>AMB</sub> =+25°C	---	---	100	nA
Power-Good threshold	V <sub>PG</sub>	LBI=0V, V <sub>OUT</sub> falling	87	91	95	%
Thermal Shutdown	T <sub>SD</sub>		---	150	---	°C
Thermal Shutdown Hysteresis	T <sub>SD_HYS</sub>		---	10	---	°C

**Minimum Footprint PCB Layout Section**

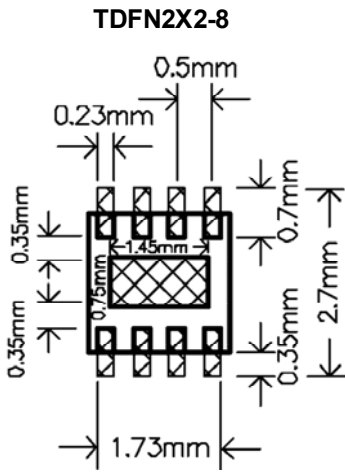

**Typical Performance Characteristics**  
( $V_{IN}=1.5V$ ,  $T_A=25^\circ C$ , unless otherwise noted.)

**Output Voltage vs. Temperature**

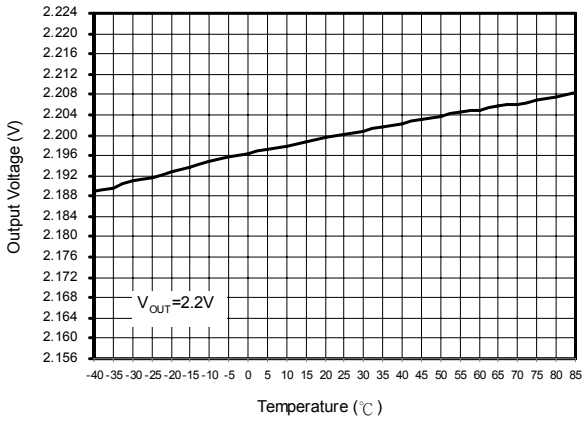

**Output Voltage vs. Temperature**

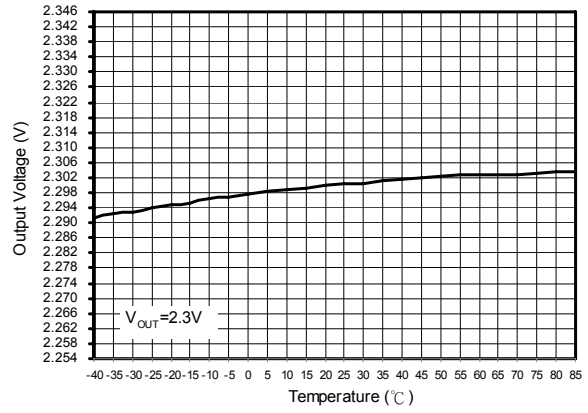

**Output Voltage vs. Temperature**

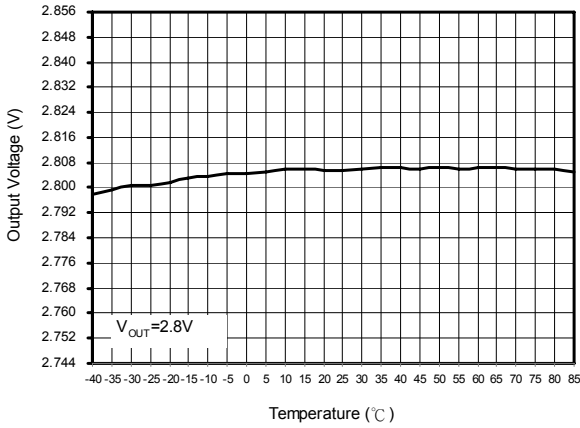

**Output Voltage vs. Temperature**

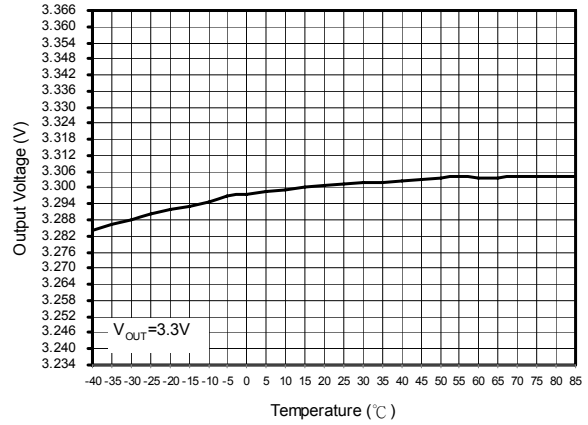

**Start-up Voltage vs. Output Current**

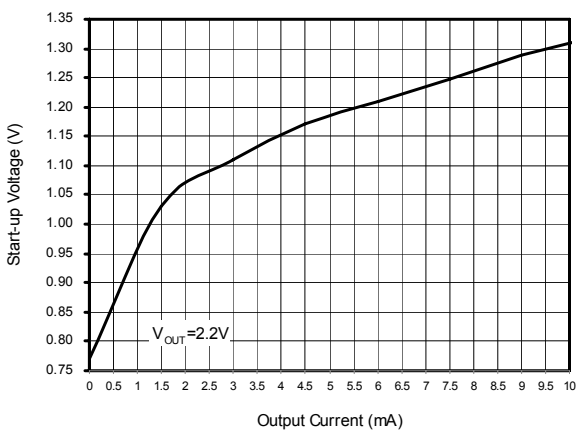

**Start-up Voltage vs. Output Current**

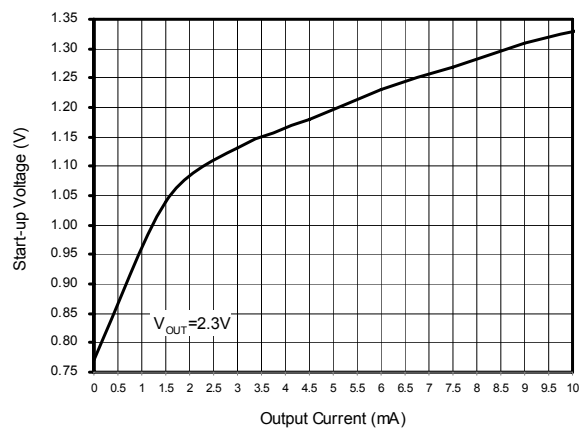

**Typical Performance Characteristics (continued)**

**Start-up Voltage vs. Output Current**

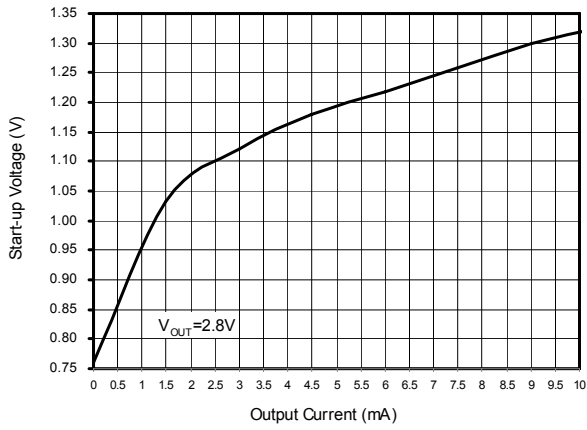

**Start-up Voltage vs. Output Current**

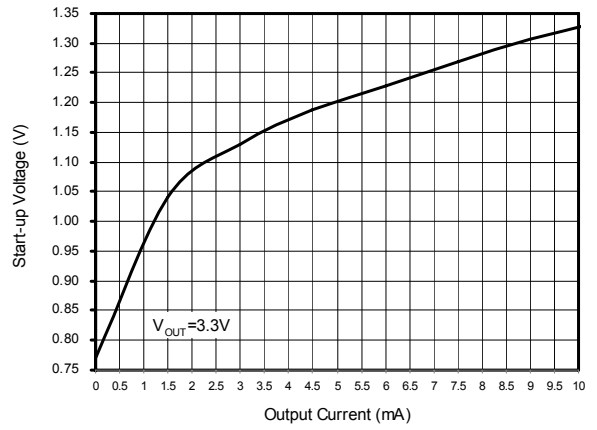

**Maximun Output Current vs. Input Voltage**

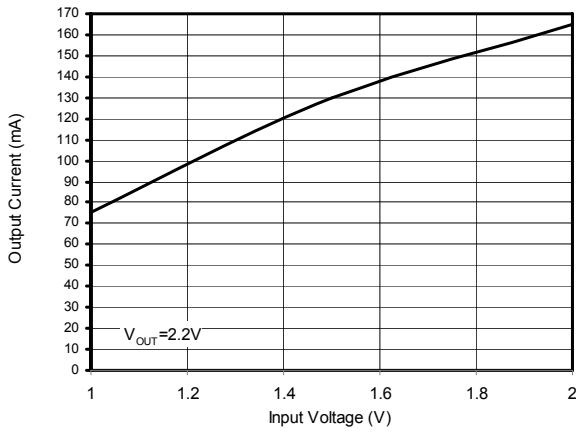

**Maximun Output Current vs. Input Voltage**

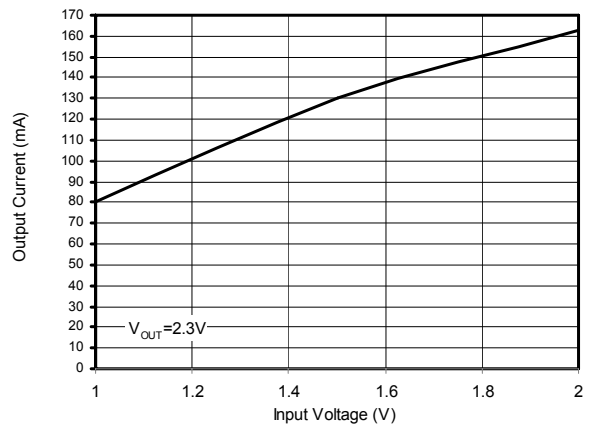

**Maximun Output Current vs. Input Voltage**

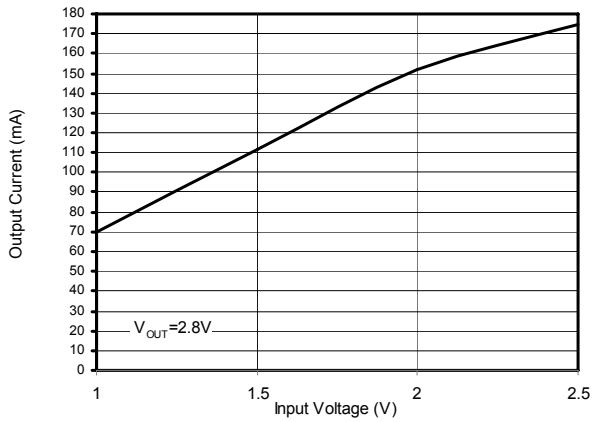

**Maximun Output Current vs. Input Voltage**

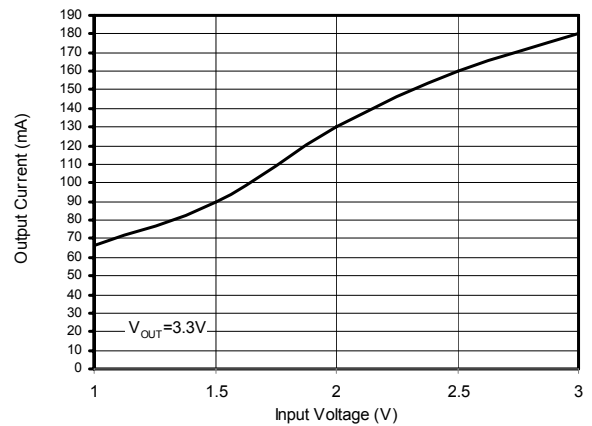

Typical Performance Characteristics (continued)

Efficiency vs. Output Current

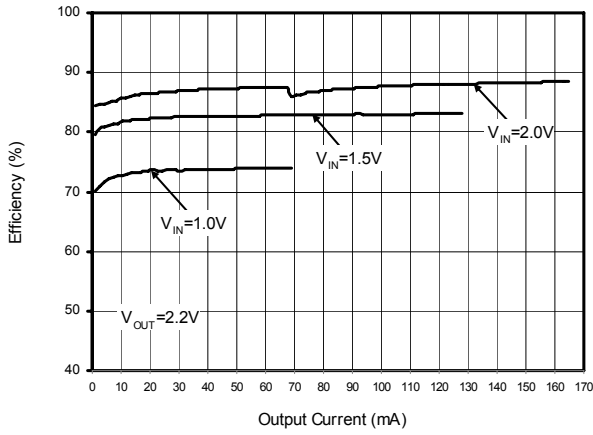

Efficiency vs. Output Current

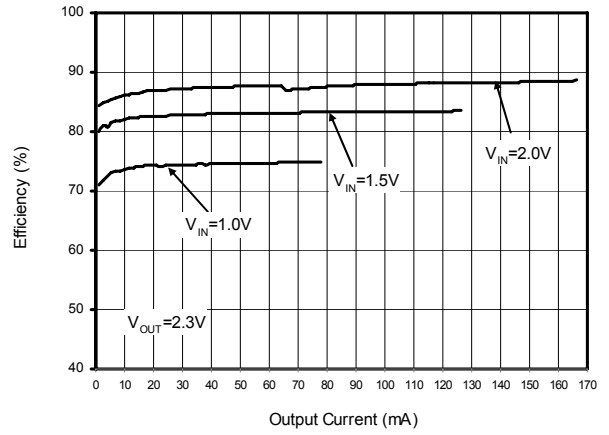

Efficiency vs. Output Current

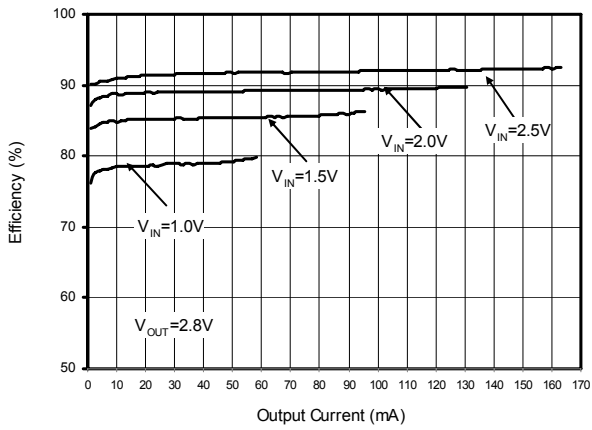

Efficiency vs. Output Current

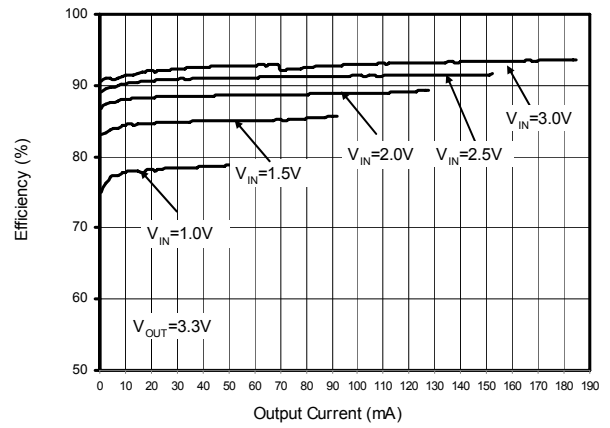

Efficiency vs. Input Voltage

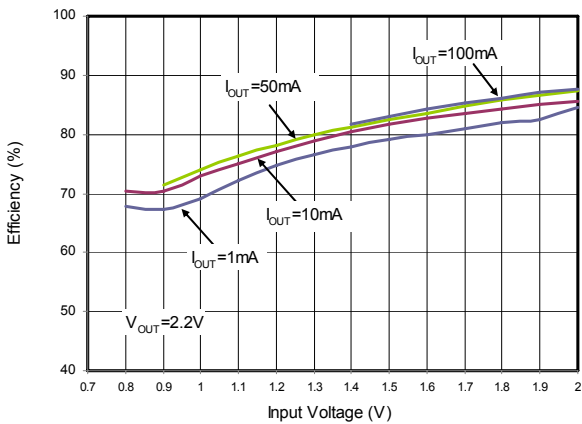

Efficiency vs. Input Voltage

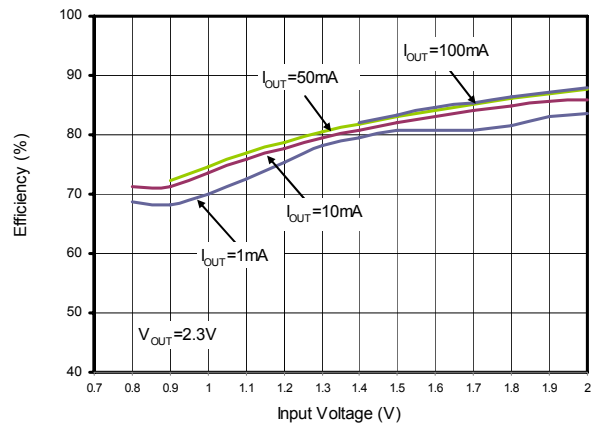

Typical Performance Characteristics (continued)

Efficiency vs. Input Voltage

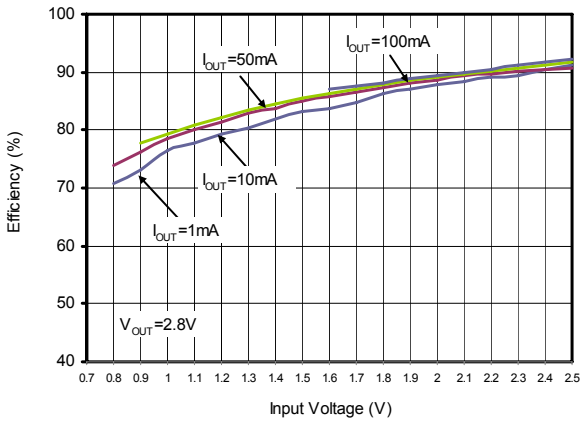

Efficiency vs. Input Voltage

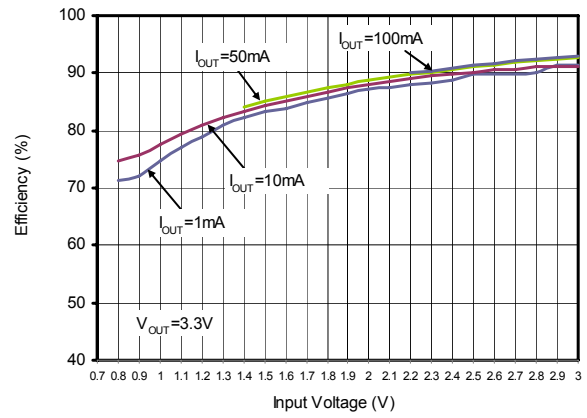

Output Voltage Ripple

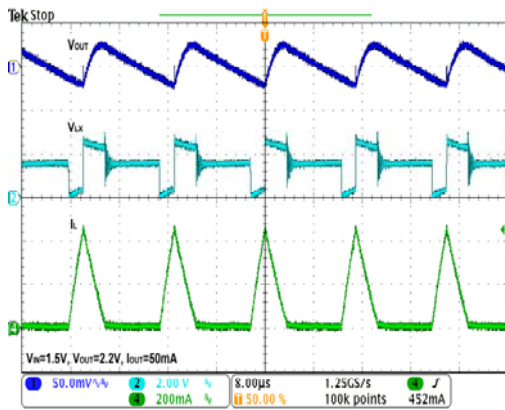

Output Voltage Ripple

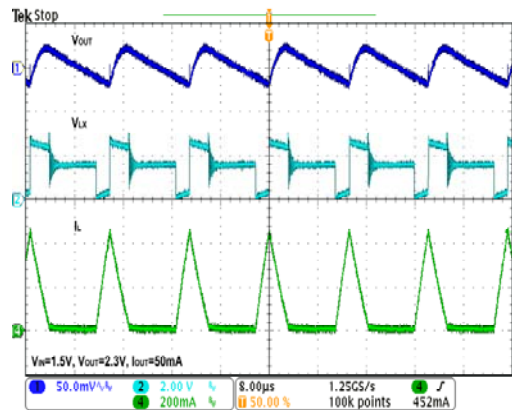

Output Voltage Ripple

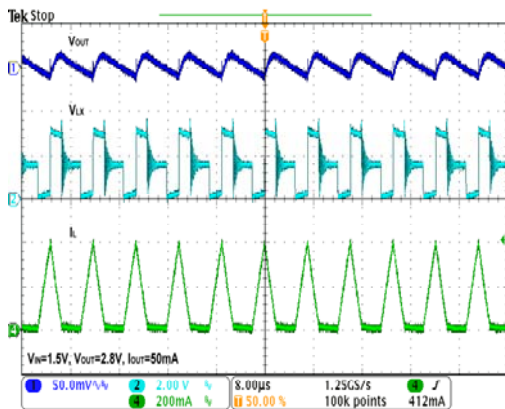

Output Voltage Ripple

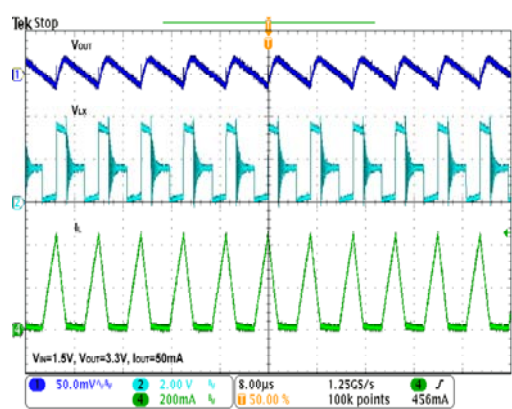

## Pin Description

Pin No	Name	Function
1	LBI	Low Battery Comparator Input. 0.6V Threshold. May not be left floating. If connected to GND, LBO is working as Power-Good function.
2	GND	Ground
3	LX	Inductor switch node of Boost converter. Connect an inductor between LX and V <sub>IN</sub> .
4	VOUT	Output voltage. Connect a ceramic capacitor as close as possible to VOUT and GND.
5	REF	Reference pin. Connect a 100nF ceramic capacitor to REF pin.
6	LBO	Low battery comparator output. Open drain output.
7	EN	Enable pin.
8	VIN	Battery voltage input. Connect a ceramic capacitor as close as possible to VIN and GND.
9	NC	Exposed pad. This pad can be left floating or connect to GND for an optimal thermal performance.

## Block Diagram

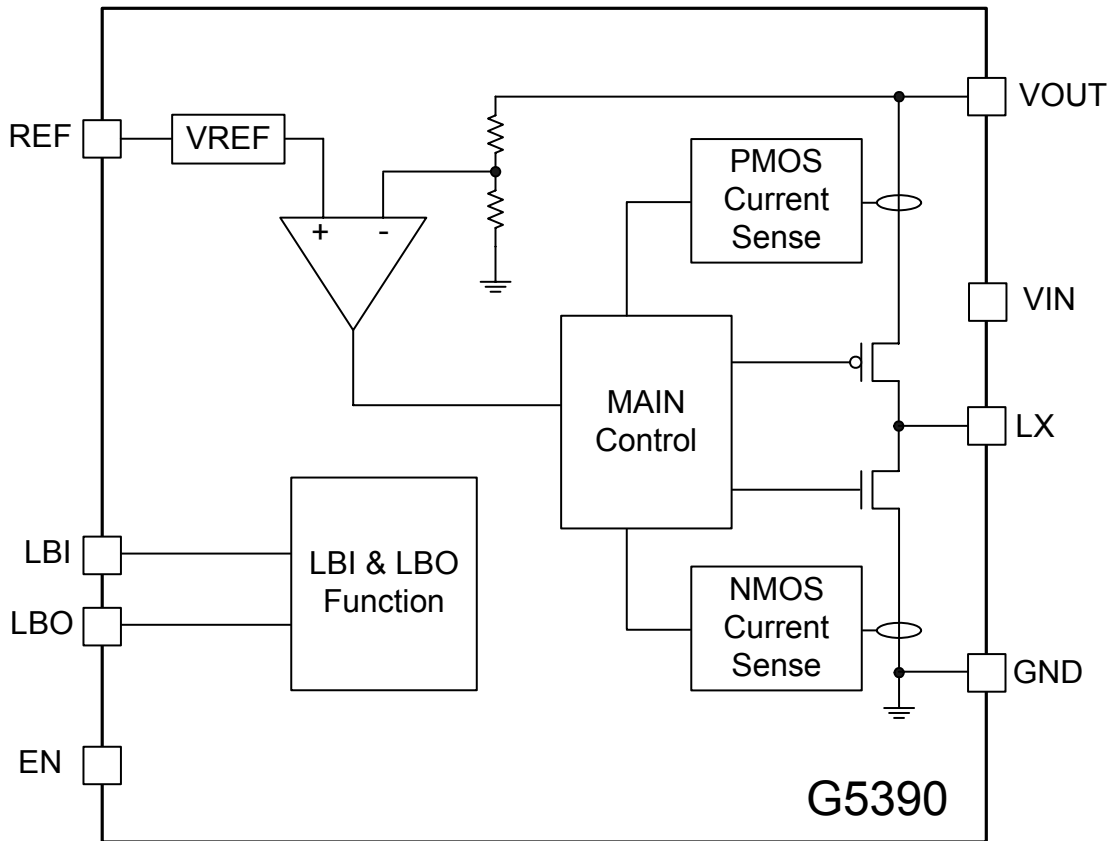



**Application circuit**

**Application with LBO working as Power Good Function**

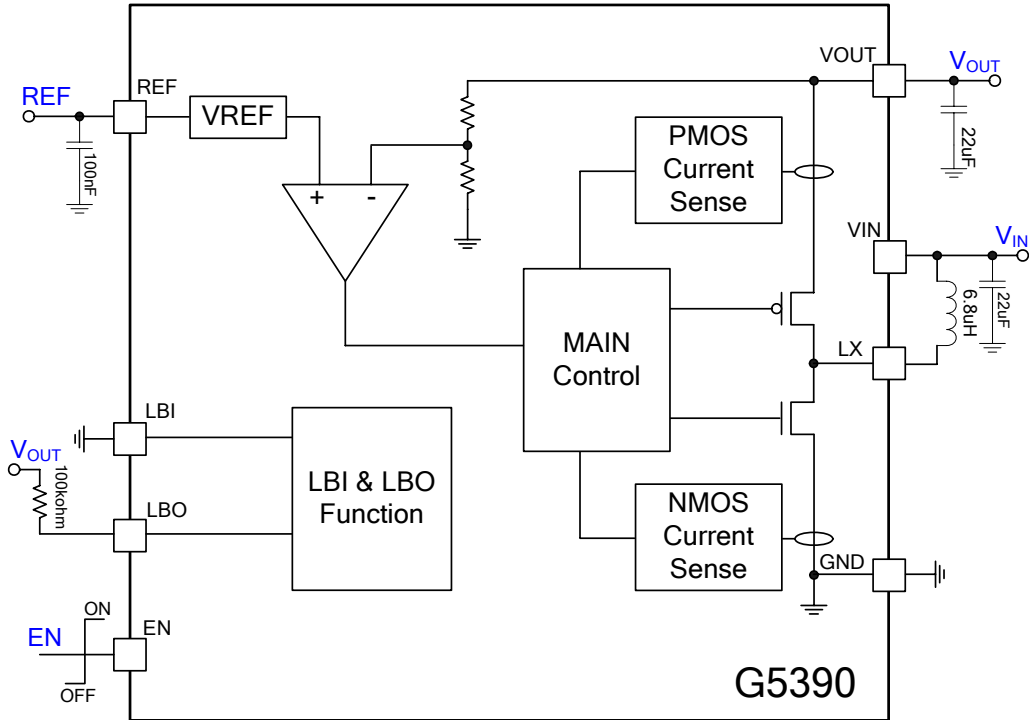

**Application with adjustable Battery Monitoring**

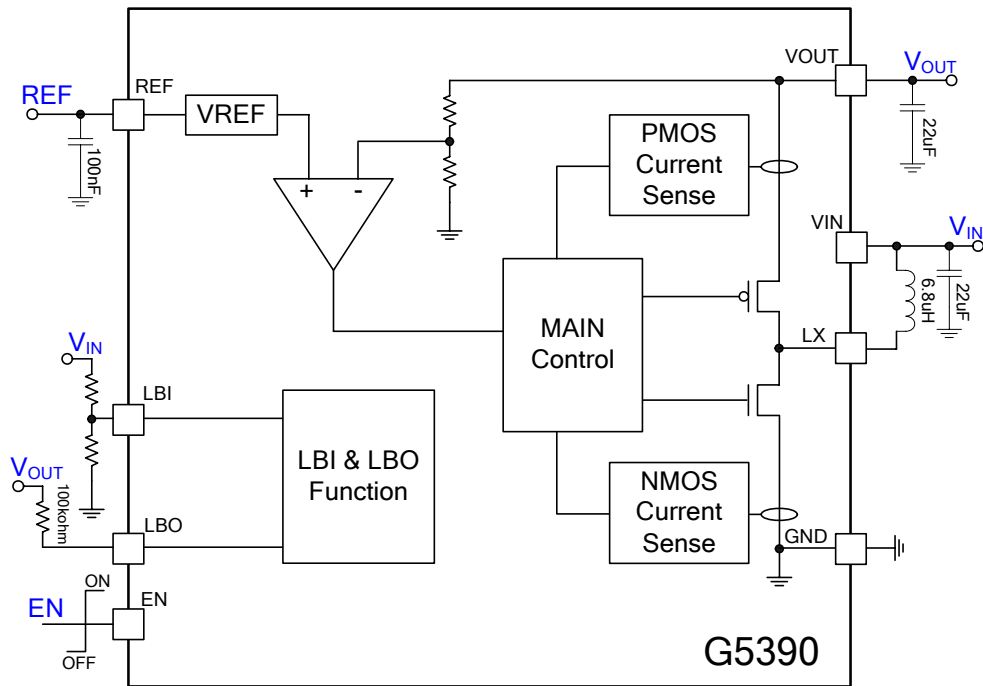

## Function Description

### Hysteretic Boost Converter

The G5390 is a hysteretic boost converter. The on-off timing is determined by detecting the current and voltage threshold. No internal continuously operating oscillator is implemented. Comparators are the main active elements and therefore the quiescent current is ultra low. In addition, because there is no fixed timing reference, the operating frequency is determined by external component (inductor and capacitors) and also the loading on the output. A power cycle is initiated when the output regulated voltage drops below the nominal value of  $V_{OUT}$ . The inductor current is monitored by the control loop, determining the on-off timing and ensuring that operation is always dis-continuous.

### NMOS On Timing

The NMOS switch will be turned on after the output regulated voltage drops below the nominal value of  $V_{OUT}$  and zero crossing current of last period occurs. The inductor current ramps up with a slope depends on the input voltage, storing energy in the inductor. The on timing of the NMOS switch is determined by the peak current detection or a maximum on time. In G5390, the peak current is 400mA (typ.) and maximum on time is 4.2 $\mu$ S (typ.). The maximum on time ensures that the NMOS switch is never permanently on.

### PMOS On Timing

When NMOS switch is turned off because reaches the peak current limit or maximum on time, the PMOS switch is turned on. The inductor current ramps down, providing the energy to the output. As the inductor current approaches zero crossing threshold (20mA typ.), the PMOS switch is turned off.

### Sleep Timing

After both NMOS and PMOS switches are turned off, the G5390 enters sleep mode. Most of the control circuits are turned off and therefore minimizes the quiescent current. No Switching action continues until the output voltage falls below the output reference point.

### Bypass Mode

The G5390 enters bypass mode if  $V_{IN} > V_{OUT}$ . In bypass mode, the PMOS switch is fully turned on and therefore  $V_{OUT}$  is directly connected to  $V_{IN}$ . The quiescent current in bypass mode is 35 $\mu$ A (typ.). The device goes back into boost mode when the output drops below 96% (typ.) of  $V_{OUTNOM}$ .

### Shutdown

The G5390 is shut down when the EN pin is below 0.1V. In shutdown mode, the PMOS switch is turned off and therefore  $V_{OUT}$  is going to 0V. No current from the input source is running through the device.

### Power-Good and Low-Battery-Detect

The LBO pin has two functions, Power-Good and Low-Battery-Detect, according to the connection of LBI pin. If LBI pin is connected to a resistive-divider, the LBO pin works as Low-Battery-Detect. LBO goes low when the voltage at the LBI pin is below 0.6V. Therefore the resistors connected at LBI pin can define a particular low-battery threshold. If LBI pin is connected to GND, an internal resistive-divider is activated and connected to the output. At this case, the LBO pin functions as Power-Good indicator. LBO goes low when  $V_{OUT}$  is below 92.5% of its nominal value.

### Thermal shutdown

The G5390 includes a thermal shutdown protection to prevent the device from overload condition. The G5390 stops switching if the junction temperature exceeds 150°C and returns to normal operation after the temperature drops below 140°C.

### Inductor Selection

G5390 is a hysteretic boost converter, therefore the operating frequency is determined by the external inductor and  $V_{IN}$ ,  $V_{OUT}$ ,  $I_{OUT}$  condition. Here provides equations to calculate the inductor value and some operation parameters.

First define the user application conditions:  $V_{INmin}$ ,  $V_{INmax}$ ,  $V_{OUT}$ . The dis-continuous operation of G5390 limits the maximum loading as:

$$I_{LOAD\_MAX} = \frac{400mA}{2} \times \frac{V_{IN}}{V_{OUT}}$$

Because the maximum on-time limit is 3.3 $\mu$ S (min.) for G5390, the the application maximum on-time has to smaller than 3 $\mu$ S (recommand), and the maximum inductor value can be calculated as:

$$L_{MAX} = \frac{T_{ONmax} \times V_{INmin}}{400mA}$$

Once the inductor value is defined, the operation frequency can be calculated as:

$$f_{MAX} = \frac{V_{IN} \times (V_{OUT} - V_{IN})}{400mA \times V_{OUT} \times L}, \text{ where } f_{MAX} \text{ happened when}$$

$$V_{IN} \text{ is } \text{MAX}\{V_{INmin}, V_{OUT}/2\}$$

$$f_{MIN} = \frac{2 \times I_{LOAD\_MIN} \times (V_{OUT} - V_{INmax})}{400mA \times 400mA \times L}$$

## PCB Layout Guidelines

Relatively high peak currents of 400mA (typ.) circulate during normal operation of the G5390. Long printed circuit tracks can generate additional ripple and noise that mask correct operation and prove difficult to “de-bug” during production testing.

Referring to schematic, the input loop formed by C1, VIN and GND pins should be minimized. Similarly, the output loop formed by C2, VOUT and GND should also be minimized. Ideally both loops should connect to GND in a “star” fashion. Finally, it is important to return CREF to the GND pin directly.

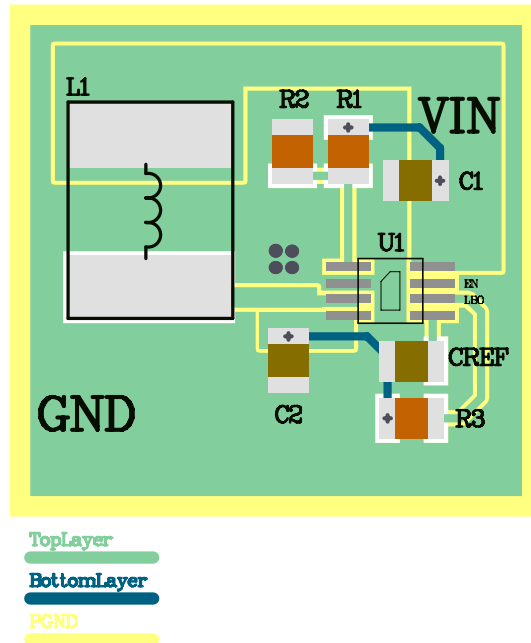

## PCB Layout

Top Layer

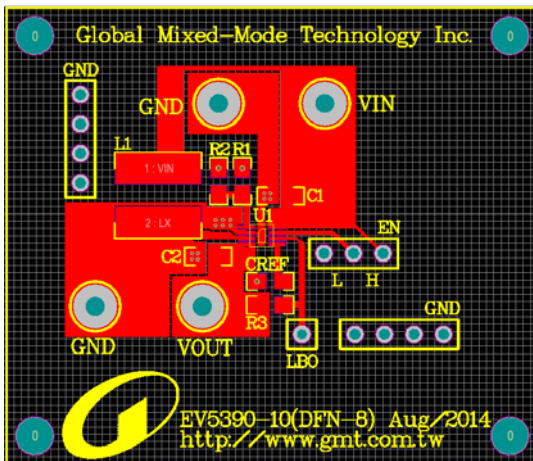

Bottom Layer

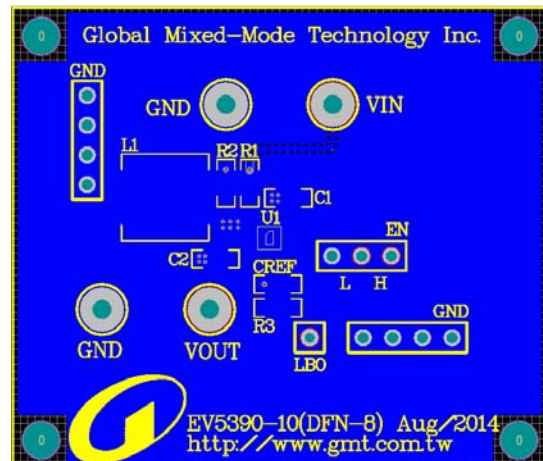

## Board Information

Board Material	FR4
Size	15.24mm*10.16mm
Board Thickness	1.6mm
Layers	2
Copper Thickness	1oz.
Thermal Resistance Junction to Ambient, ( $\theta_{JA}$ ),	60°C/W

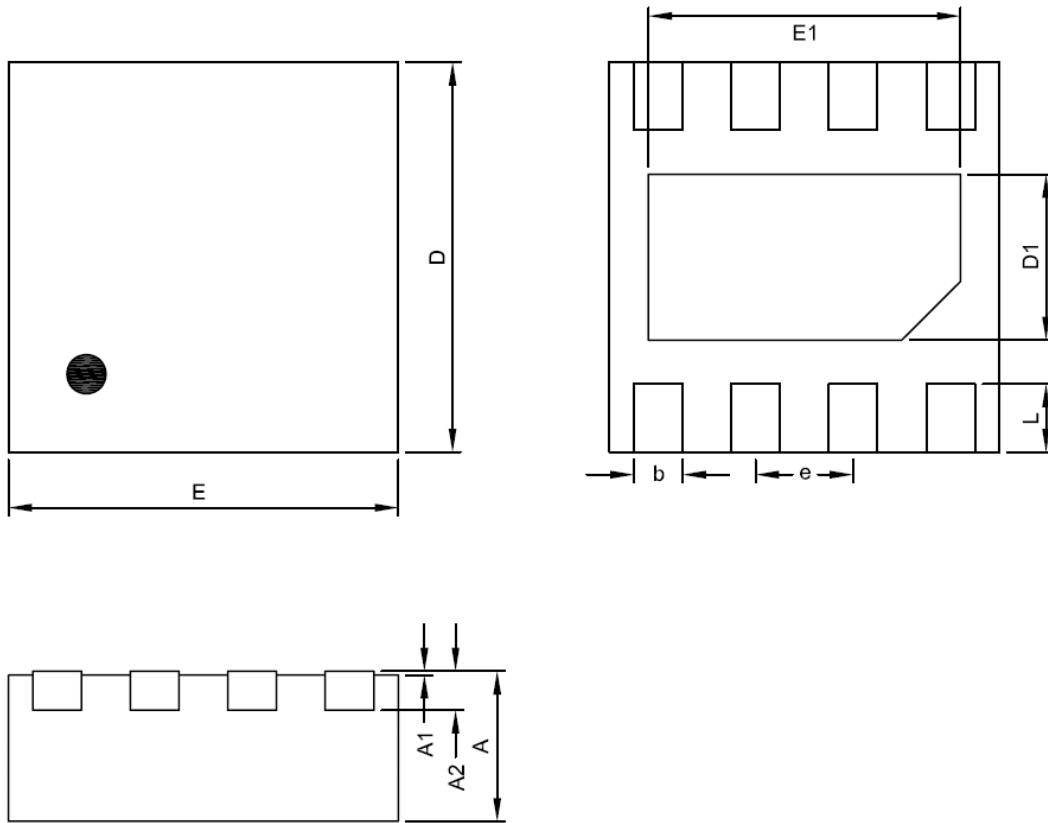
**Package Information**

**TDFN2X2-8 Package**

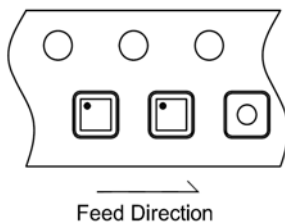
Symbol	DIMENSION IN MM			DIMENSION IN INCH		
	MIN.	NOM.	MAX.	MIN.	NOM.	MAX.
A	0.70	0.75	0.80	0.0276	0.0295	0.0315
A1	0.00	---	0.05	0.0000	---	0.0020
A2	0.20 REF			0.0079 REF		
D	1.95	2.00	2.05	0.0768	0.0787	0.0807
E	1.95	2.00	2.05	0.0768	0.0787	0.0807
D1	0.75	0.85	0.95	0.0295	0.0335	0.0374
E1	1.45	1.55	1.65	0.0571	0.0610	0.0650
b	0.15	0.23	0.30	0.0059	0.0091	0.0118
e	0.50 BSC			0.0197 BSC		
L	0.30	0.35	0.40	0.0118	0.0138	0.0157

**Taping Specification**

PACKAGE	Q'TY/REEL
TDFN2X2-8	3,000 ea

GMT Inc. does not assume any responsibility for use of any circuitry described, no circuit patent licenses are implied and GMT Inc. reserves the right at any time without notice to change said circuitry and specifications.

Ver: 0.6

May 14 2018

## X-ON Electronics

Largest Supplier of Electrical and Electronic Components

*Click to view similar products for [Isolated DC/DC Converters](#) category:*

*Click to view products by [GMT\(Global Mixed-mode Tech\)](#) manufacturer:*

Other Similar products are found below :

[ESM6D044440C05AAQ](#) [FMD15.24G](#) [PSL486-7LR](#) [PSR152.5-7IR](#) [Q48T30020-NBB0](#) [AVO240-48S12B-6L](#) [AVO250-48S28B-6L](#) [NAN-0505](#) [HW-L16D](#) [JAHW100Y1](#) [217-1617-001](#) [22827](#) [SPB05C-12](#) [SQ24S15033-PS0S](#) [18952](#) [19-130041](#) [CE-1003](#) [CE-1004](#) [GQ2541-7R](#) [PSE1000DCDC-12V](#) [RDS180245](#) [MAU228](#) [419-2065-201](#) [449-2075-101](#) [J80-0041NL](#) [V300C24C150BG](#) [419-2062-200](#) [419-2063-401](#) [419-2067-101](#) [419-2067-501](#) [419-2068-001](#) [DCG40-5G](#) [DFC15U48D15](#) [449-2067-000](#) [XGS-0512](#) [XGS-1205](#) [XGS-1212](#) [XGS-2412](#) [XGS-2415](#) [XKS-1215](#) [033456](#) [NCT1000N040R050B](#) [SPB05B-15](#) [SPB05C-15](#) [SSQE48T25025-NAA0G](#) [L-DA20](#) [HP3040-9RG](#) [HP1001-9RTG](#) [XKS-2415](#) [XKS-2412](#)