

100mW TTL Interface Small Size Embedded
Wireless Transceiver Data Transmission Module

Product Specification

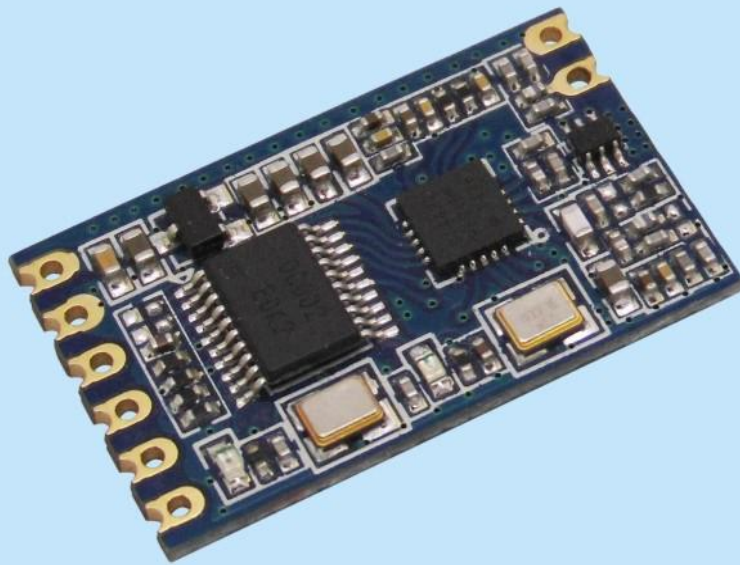

Catalogue

1. Overview.....	- 3 -
2. Features.....	- 3 -
3. Application.....	- 3 -
4. Block Diagram.....	- 3 -
5. Electrical Characteristics.....	- 4 -
6. Operation.....	- 4 -
1) Power on Reset.....	- 4 -
2) Sleep mode.....	- 5 -
3) Working Mode.....	- 5 -
4) Setting mode.....	- 7 -
5) Communication Protocol.....	- 8 -
6) RSSI index.....	- 10 -
7) Parameters Description:.....	- 10 -
7. Application circuit.....	- 12 -
8. Pin definition.....	- 13 -
9. Accessories.....	- 13 -
10. Mechanical dimension.....	- 15 -
11. Order information.....	- 15 -
12. FAQ.....	- 16 -
Appendix: SMD Reflow Chart.....	- 17 -

Note: Revision History

Revision	Date	Comment
V1.0	2011-9-2	First release
V2.0	2012-5-6	Updated data rate to 115200bps
V3.0	2014-10-28	Add delay time
V4.0	2015-4-18	Add communication protocol
V4.1	2017-06	Logo updated
V4.2	2020-11	Modify mechanical dimension
V5.0	2020-12	logo and cover updated

1. Overview

SV610 is an Industrial class & highly-integrated RF transceiver module. SV610 has a standard TTL interface, SV610 has good sensitivity and 100mW output power to achieve long RF range and reliable RF communication. To avoid the interference, SV610 provides 40 frequency channels and configurable Net ID. SV610 is flexible but easy to use, it comes with many parameters, such as: frequency, data rate, output power, Net ID, Node ID. Users can configure the parameters through PC or customer's own device.

SV610 strictly uses lead-free process for production and testing, and meets RoHS and Reach standards.

2. Features

- 433/490/868/915 MHz
(Customizable 240-930 MHz)
- Industrial class
- 40 channels
- 4 bytes Net ID & 2 bytes Node ID
- Series Data Rate: 1200 ~ 115200 bps
- Air Data Rate: 1200 ~ 115200 bps
- GFSK modulation
- RSSI
- Interface: TTL
- Antenna matching automatically
- Bi-directional & Half duplex
- Sensitivity: -121 dBm
- Max output power: 100mW (+20 dBm)
- Working voltage: 3.3 ~ 7.0 V
- Working temperature : -40 ~ +85 °C
- Weight: 2.0 g
- Parameters save automatically

3. Application

- Remote control telemetry
- Security system
- Industrial data acquisition
- Home automation
- Wireless data communication
- Access system
- Robot control
- Wireless PC peripherals

4. Block Diagram

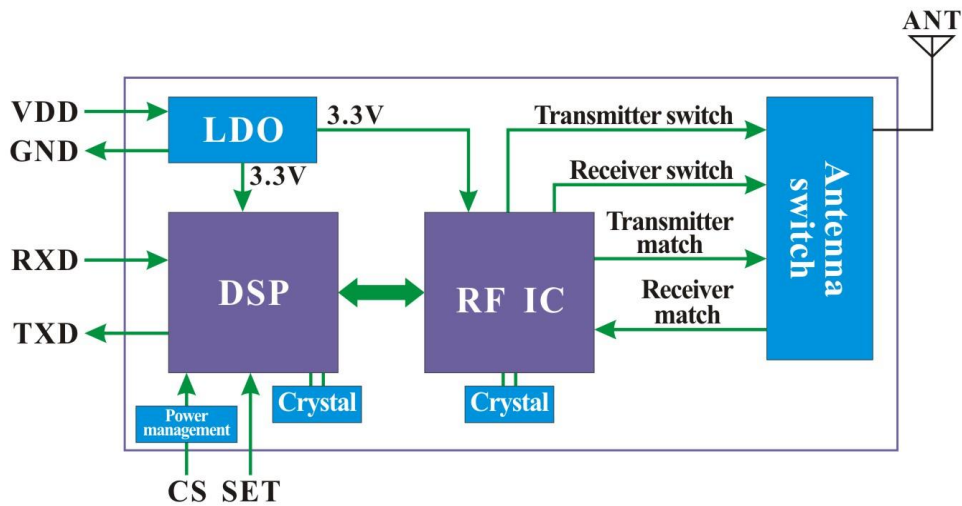

5. Electrical Characteristics

Note: High quality 3.3V LDO is integrated, and Pin CS / SET is 3.3V interface. TXD/RXD is also 3.3V for SV610-TTL

Parameters	Min.	Typ.	Max.	Unit	Condition
Working Condition					
Voltage range	3.3	5.0	7.0	V	TTL level
Operating Temperature	-40	25	+85	°C	
Current Consumption					
Rx current		25		mA	TTL level
Tx current		95		mA	@20dBm
Sleep current		≤5		uA	@TTL level
RF Parameters					
Frequency range	414.92	433.92	453.92	MHz	@433MHZ
	470.92	490.92	509.92	MHz	@490MHZ
	849.92	868.92	888.92	MHz	@868MHZ
	895.92	914.92	934.92	MHz	@915MHZ
Data rate	1.2	9.6	115.2	Kbps	GFSK
Output power	-1	/	+20	dBm	
Sensitivity		-121		dBm	@1.2Kbps

6. Operation

1) Power on Reset

After powered on reset, the TX LED (Red) and RX LED (Blue) will blink 3 times , The total reset time is around 2s, as below:

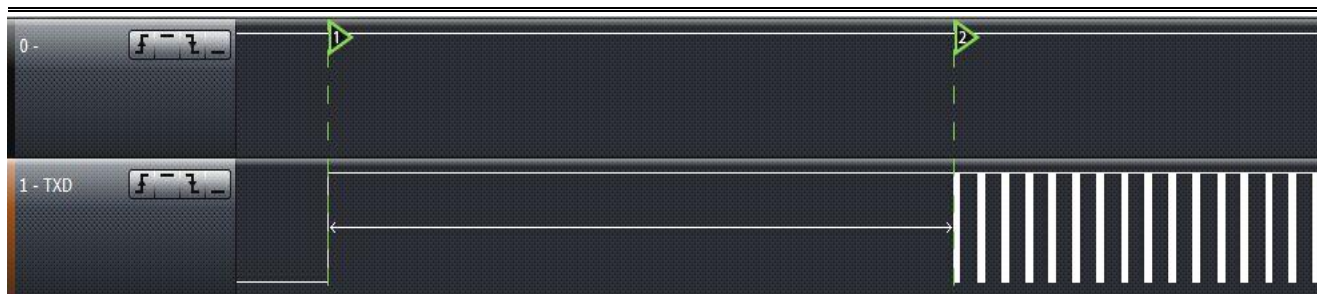

Note: Contact us to customize if you want to shorten the POR time.

2) Sleep Mode

After Power on Reset, the module enters into sleep mode when CS pin is pulled low. In this mode, the current consumption is very small. In Sleep mode, the module can't do any communication and can't be set even Set Pin is pulled low. All the parameters will be kept unchanged in Sleep mode. User can wake up the module by pulling high the CS Pin.

3) Working Mode

The CS and SET Pin is internally pulled up. Pull CS pin high or leave it open will make SV610 enter into working mode.

	Sleep mode	Working mode	Setting mode
CS	0	1*	1*
SET	X	1*	0

★ 1*: connected to 3.3V or leave open. X: don't care

In working mode, SV610 stay in receiving mode and wait for the series signal and RF signal.

SV610 can connect with any device which is standard TTL interface.

When series signal comes, SV610 will check the input series signal if there is any error, and then transmit the received data out via RF automatically if no errors found.

When RF signal comes, SV610 will check the input RF signals if there is any error, and then transmit the received data out via series port automatically if no errors found.

When one packet is transmitted successfully, the Red LED will blink once.

When one packet is received and verified with no problem, the Blue LED will blink once.

The easiest way to test the module is using computer. The corresponding PC software is "Series Debugging Assistant" can be downloaded at: http://www.nicerf.com/downlist_173.html, the password for download is "nicerf". User can use our USB bridge board SU108 -TTL to connect SV610 with computer.

The GUI of the software is as below:

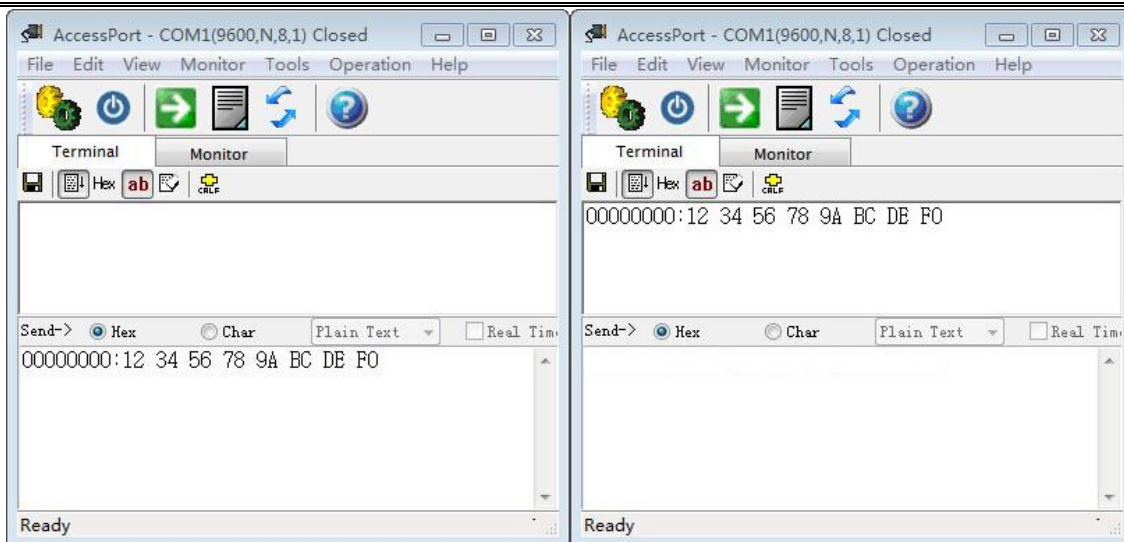

★ To ensure the stability of communication, please notice the following tips:

a) Parameter matching

The series parameter between the device and SV610 should be same.

RF parameters should be same in Tx and Rx.

The Net ID should be same in Tx and Rx.

b) Delay Time

Data delay is exist between series input of the transmitter and series output of the receiver. This Delay Time is different from the series data rate, RF data rate and payload length. Detailed value is as below:

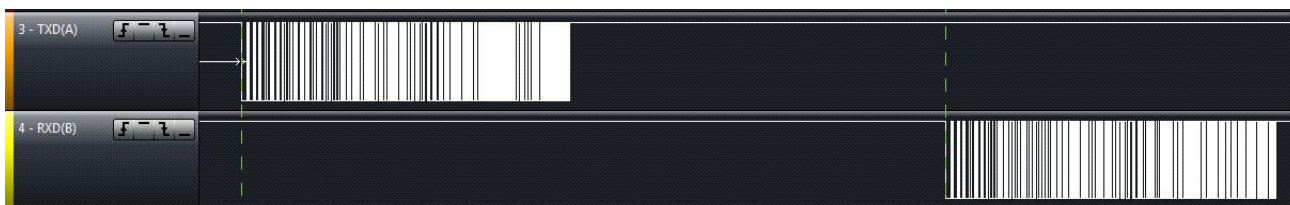

Speed rate	1200	2400	4800	9600	14400	19200	38400	57600	76800	115200
1byte transceiver time(ms)	140	70	37	21	15	13	9	8	8	7
56bytes transceiver time(ms)	945	475	241	124	85	65	36	26	21	16

c) Long package transmission

One packet more than 200 bytes is a long package. The RF data should be set higher than series data

for long package transmission. The distance will be shorter with higher RF data rate.

4) Setting Mode

In working mode, pull low the SET pin to force SV610 into setting mode. When using USB bridge board, simply put on the short cap to enter into setting mode.

In setting mode, both blue and red LED will light on, shown as below:

Data Transceiver Module TTL Interface Diagram

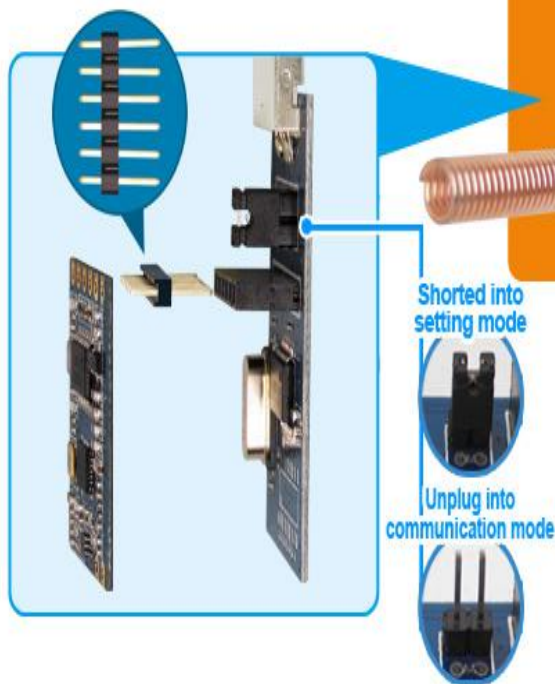

- Install the USB Driver and PC software in computer.
- Connect Module with TTL USB bridge board through 6 pins.
- Connect Module with computer (PC Software) through TTL USB bridge board.
- Module has been into setting Mode at this time, Red and Blue color light keep lighting, show as above.

In setting mode, users can set the parameters by PC software or customer's own device. The parameters will be stored and keep unchanged even powered off.

Step to set the module with PC:

- ◆ Download the PC software and USB driver at our website.
- ◆ Install the PC software and USB driver into computer.
- ◆ Connect RF module with USB Bridge, put on the short cap, and insert into the PC.
- ◆ Open the PC software, the GUI is as below:

Select the right COM port and click "OPEN" button, all the parameters stored in the module will be read out and display, the status bar will appear the message "Device Found".

If SV610 hasn't connected with PC correctly or wrong COM port is chosen, the status bar will show "Device Not Found".

Note: About the Net ID and Node ID

After connected with PC correctly, all the parameters can be set freely including Net ID and Node ID. The Net ID is the group name for transmitter and receiver, all the transmitter and receiver with the same Net ID can communicate with each other. The only exception is 0000. When the Net ID is set as 0000, it can receive the signal of all the transmitter even the Net ID is not 0000.

The Node ID can be thought as the name of the module. Each module can be set with one Node ID. The Node can set and read out freely. The Node ID can be used in the application which the receiver should identify who is the transmitter. User can read out the Node ID of the module, and add the Node ID into the payload, then in Rx side, it can identify who is the transmitter.

5) Communication Protocol

a) Command : Read module name and version:

Besides PC, user can set all the parameters by their own device. The communication protocol is as below:

Baud rate=9600 bps; Data bit=8 bits Stop bit:1 Parity bit: none

Instruction format: AA FA AA

Return value is: "SV610_VERx.x\r\n"

For example:

Instruction: AA FA AA

Return: SV610_Ver4.6\r\n.

Instruction format: AA FA 01

The return value in turn is:

RF channel / RF band / RF data rate / RF power / Serial data rate / Series Data bit / Series Stop bit / Series Parity bit / NET ID / NODE ID \r\n

For example, when module is default setting, the return are as below:

Instruction format: AA FA 02

The return value in turn is: "OK\r\n" or "ERROR\r\n"

After this command , the module will reset to default setting ,which is

Frequency : Tx = Rx = CH20 = 433.92 MHz (Band = 433MHz)

b) Command: Read out all the parameters:

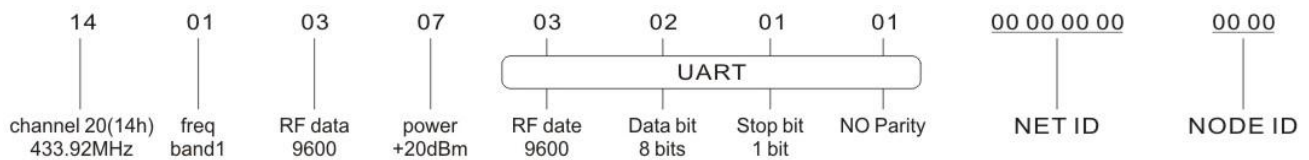

c) Command : Reset to default setting

RF data rate: Tx = Rx=9600 bps

RF power= 7 (Max output)

Serial: baud rate = 9600 bps Data bit= 8 Bits Stop bit = 1 Bits Parity bit=None

NET ID = 00 00 00 00 NODE ID = 00 00

d) Command: Set the group parameters

Length of the command is 17 bytes, set 14 bytes of the parameters into the module, and format as follows:

Instruction format: AA FA 03 RF Channel / RF Band / RF Rate / RF Power / Serial transmission date / data bits / stop bits / parity / NET ID / NODE ID

The return is: "OK \r \n" or "ERROR \r \n"

6) RSSI index

The RSSI index value can only be read out in setting mode. The real time RSSI index is updated by incoming signal.

Instructions format: AA FA 04

Return: RSSI index\00\r\n (hexadecimal, range: 0x00~0xff)

RSSI index range: 00 ~ FFh

For example:

Instruction format: AA FA 04

Return:32 00 \r\n.

Relationship between RSSI and input power is as below

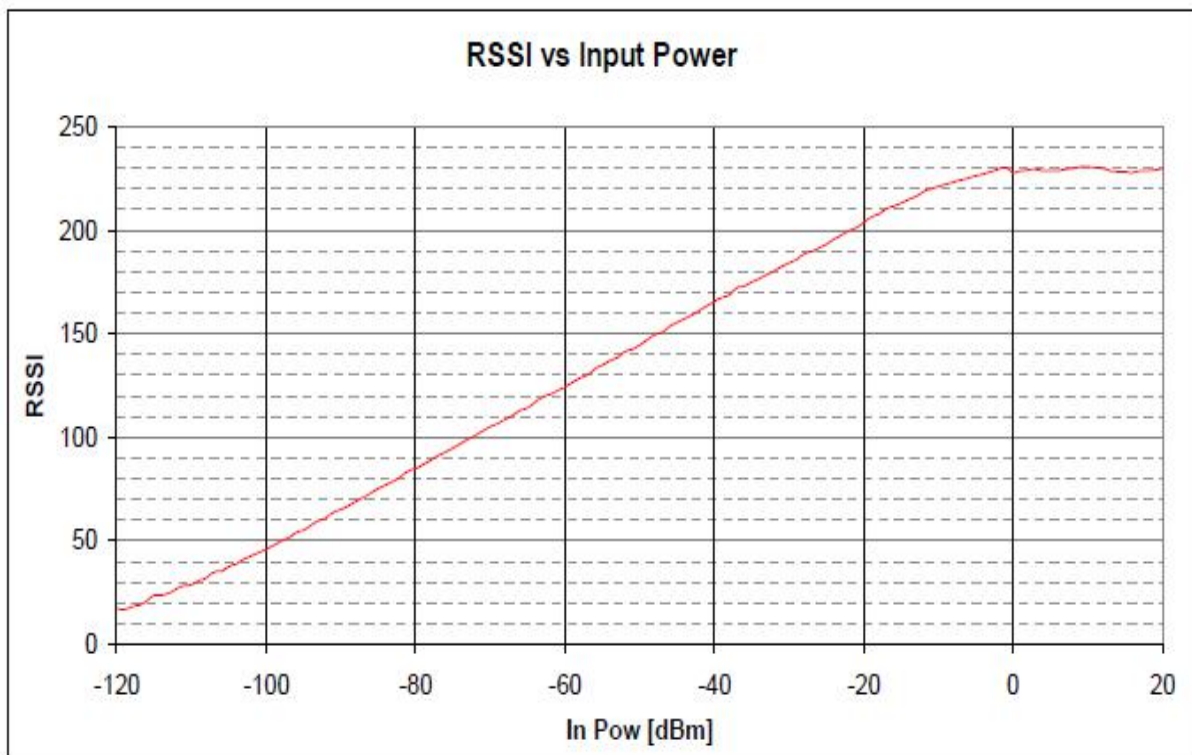

7) Parameters Description:

a) RF Channel = RF Frequency

Each frequency band is divided into 40 channels; user can select one of the 40 channels to use. The corresponding frequency is as below, Also we can customized the specified frequency which is not in the table.

frequency band1	channel	1	2	3	4	5	6	7	8	9	10
433MHz	frequency	414.92	415.92	416.92	417.92	418.92	419.92	420.92	421.92	422.92	423.92
	channel	11	12	13	14	15	16	17	18	19	20
	frequency	424.92	425.92	426.92	427.92	428.92	429.92	430.92	431.92	432.92	433.92
	channel	21	22	23	24	25	26	27	28	29	30
	frequency	434.92	435.92	436.92	437.92	438.92	439.92	440.92	441.92	442.92	443.92
	channel	31	32	33	34	35	36	37	38	39	40
frequency	444.92	445.92	446.92	447.92	448.92	449.92	450.92	451.92	452.92	453.92	
frequency band2	channel	1	2	3	4	5	6	7	8	9	10
470MHz	frequency	470.92	471.92	472.92	473.92	474.92	475.92	476.92	477.92	478.92	479.92
	channel	11	12	13	14	15	16	17	18	19	20
	frequency	480.92	481.92	482.92	483.92	484.92	485.92	486.92	487.92	488.92	489.92
	channel	21	22	23	24	25	26	27	28	29	30
	frequency	490.92	491.92	492.92	493.92	494.92	495.92	496.92	497.92	498.92	499.92
	channel	31	32	33	34	35	36	37	38	39	40
frequency	500.92	501.92	502.92	503.92	504.92	505.92	506.92	507.92	508.92	509.92	
frequency band3	channel	1	2	3	4	5	6	7	8	9	10
868MHz	frequency	849.92	850.92	851.92	852.92	853.92	854.92	855.92	856.92	857.92	858.92
	channel	11	12	13	14	15	16	17	18	19	20
	frequency	859.92	860.92	861.92	862.92	863.92	864.92	865.92	866.92	867.92	868.92
	channel	21	22	23	24	25	26	27	28	29	30
	frequency	869.92	870.92	871.92	872.92	873.92	874.92	875.92	876.92	877.92	878.92
	channel	31	32	33	34	35	36	37	38	39	40
frequency	879.92	880.92	881.92	882.92	883.92	884.92	885.92	886.92	887.92	888.92	
frequency band4	channel	1	2	3	4	5	6	7	8	9	10
915MHz	frequency	895.92	896.92	897.92	898.92	899.92	900.92	901.92	902.92	903.92	904.92
	channel	11	12	13	14	15	16	17	18	19	20
	frequency	905.92	906.92	907.92	908.92	909.92	910.92	911.92	912.92	913.92	914.92
	channel	21	22	23	24	25	26	27	28	29	30
	frequency	915.92	916.92	917.92	918.92	919.92	920.92	921.92	922.92	923.92	924.92
	channel	31	32	33	34	35	36	37	38	39	40

b) Working Band

The working band is as below

Parameter	01	02	03	04
Frequency	433 MHz	490 MHz	868 MHz	915 MHz
	414.92 ~ 453.92	470.92 ~ 509.92	849.92 ~ 888.92	895.92 ~ 934.92

Note: Changing working band is not suggested

c) RF data rate

The RF data rate is as below : 1200 2400 4800 9600 14400 19200 38400 57600 76800 115200 bps

Parameter	0	1	2	3	4	5	6	7	8	9
TX/RX rate(bps)	1200	2400	4800	9600	14400	19200	38400	57600	76800	1152000

d) RF output power

The output power is as below:

Set level	0	1	2	3	4	5	6	7
TX/RX power	+1 dBm	+2 dBm	+5 dBm	+8 dBm	+11 dBm	+14 dBm	+17 dBm	+20 dBm

e) Serial baud rate

Series data rate is as below:

Parameter	0	1	2	3	4	5	6	7	8	9
Serial rate(bps)	1200	2400	4800	9600	14400	19200	38400	57600	76800	115200

f) Serial data bit

Series data bit is as below:

Parameter	1	2	3
Data Bits	7 bits	8 bits	9 bits

g) Serial stop bit

Series stop bit is as below:

Parameter	1	2
Stop bit	1 bits	2 bits

h) Serial parity

Series Parity bit is as below:

Parameter	1	2	3
Parity bit	No	Odd	Even

i) NET ID:

The Net ID is 4 bytes, and range from 00 00 00 00 to FF FF FF FF

Note: if the modules' NET ID setting are different, then they can't communicate with each other except when the Net ID = 0000, it will receive all the message despite the Net ID is difference.

j) NODE ID

The Node ID is 2 bytes, range from 00 00 to FF FF.

7. Application circuit

The typical schematic circuit is as below:

Note: The ground pin of the module and device should be connected together.

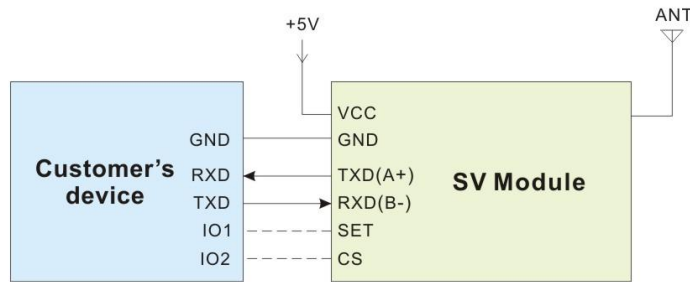

Typical application::

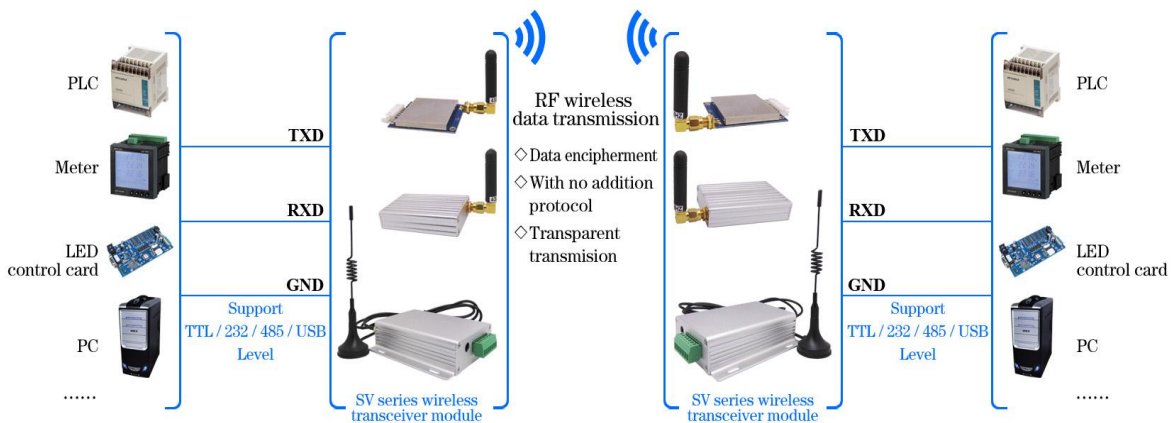

8. Pin definition

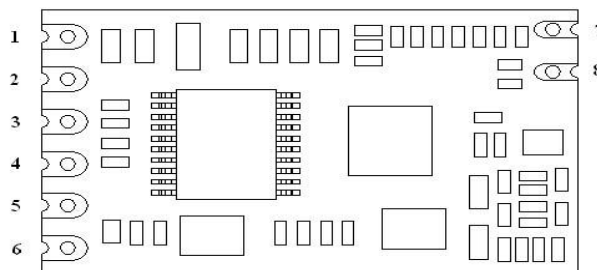

Pin No.	Definition	Description
1	VCC	Connected to the positive power supply (typical 5V)
2	GND	Connected to ground
3	TXD	TXD of the module and connect to external RXD
4	RXD	RXD of the module and connect to external TXD
5	SET	Configuration mode enable (low to enter into the setting mode, leave open or connect high level to exit setting mode) Valid when CS Pin is high or leave open.
6	CS	Module working Enable (Pull Low to make the module enter into sleep mode, Leave open or connect high level make the module enter into normal working mode)
7	GND	Antenna ground

8	ANT	Access antenna (50 ohm coaxial antenna)
---	-----	---

9. Accessories

1) Antenna

The antenna is very important for RF communication. We have many kinds of antenna for customer to choose, please contact the corresponding sales engineer for help.

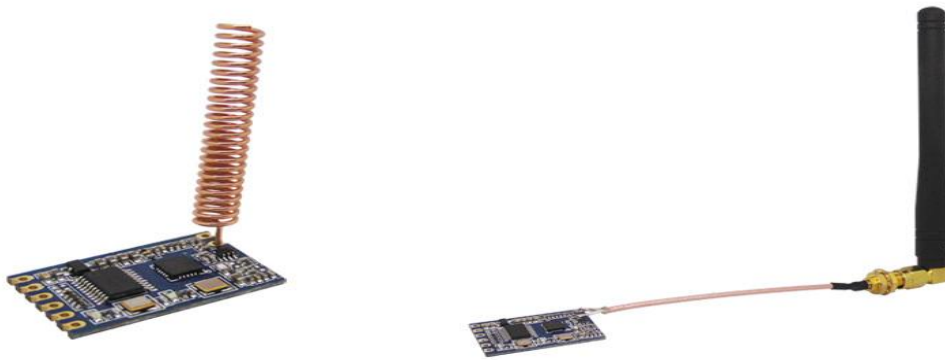

★ Tips for antenna:

- Don't close to the ground, metal, magnet, big current;
- If you are using the sucker antenna, pull the wire as straight as possible, the sucker foundation should stick with metal

2) USB bridge board

There are 3 type of USB bridge, which is SU108-TTL/ SU108-232 / SU108-485. SU108 -TTL is for TTL Interface, SU108-232 is for 232 Interface, SU108 - 485 is for 485 Interface. User should select the right USB bridge corresponding to the RF module.

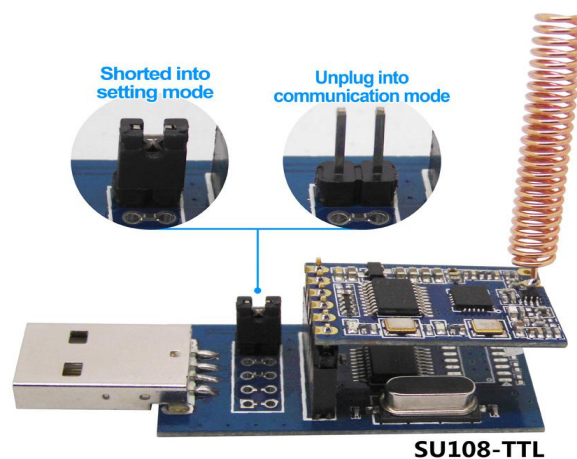

10. Mechanical dimension(Unit: mm)

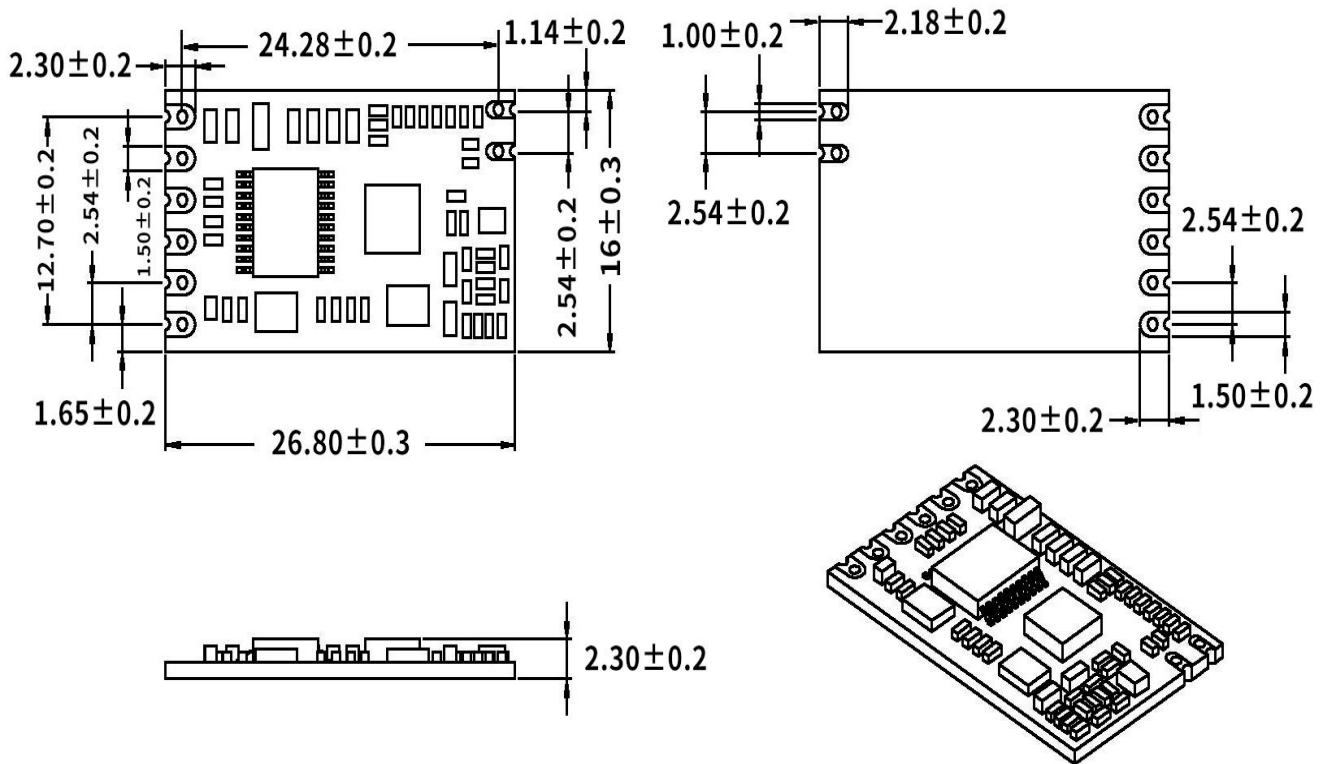

11. Order information

SV610-433

└ Center frequency

For example:

If the customer needs 433MHz band then part number of released order shall be: SV610-433

Note: SV610 only has TTL interface

Product Name	Description
SV610-TTL- 433	433MHZ, TTL interface
SV610-TTL- 490	490MHZ, TTL interface
SV610-TTL- 868	868MHZ, TTL interface
SV610-TTL- 915	915MHZ, TTL interface

12.FAQ

- **Why module can not communicate properly?**
 - a) Check if the band, channel, rate, NET ID has set to the same;
 - b) Check if there is power connection error;
 - c) Check if the module is enabled (CS high);
 - d) Check if the antenna connection is not correct;
 - e) Check if the module is damaged.

- **Why transmission distance is not far as it should be?**
 - a) Power supply ripple is too large;
 - b) The antenna types do not match, or not properly installed;
 - c) The surrounding environment is harsh, strong interference sources;
 - d) Surrounding co-channel interference;

- **Why receiving data incorrect?**
 - a) Improper parameter settings;
 - b) Module data interface is bad.

Appendix: SMD Reflow Chart

We recommend you should obey the IPC related standards in setting the reflow profile:

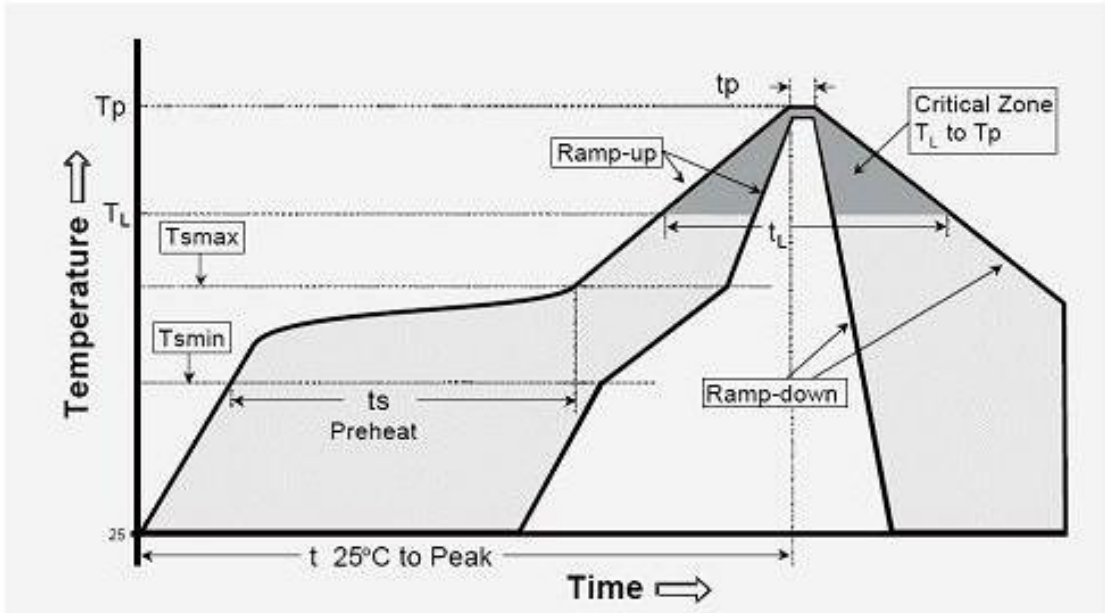

IPC/JEDEC J-STD-020B the condition for lead-free reflow soldering	big size components (thickness $\geq 2.5\text{mm}$)
The ramp-up rate (T _L to T _p)	3°C/s (max.)
preheat temperature	
- Temperature minimum (T _{min})	150°C
- Temperature maximum (T _{max})	200°C
- preheat time (t _s)	60~180s
Average ramp-up rate(T _{max} to T _p)	3°C/s (Max.)
- Liquidous temperature(T _L)	217°C
- Time at liquidous(t _L)	60~150 second
peak temperature(T _p)	245+/-5°C

X-ON Electronics

Largest Supplier of Electrical and Electronic Components

Click to view similar products for [RF Modules](#) category:

Click to view products by [G-NiceRF](#) manufacturer:

Other Similar products are found below :

[2221706-1](#) [RAD-900-DAIO6](#) [650200791G](#) [650200714G](#) [RFM95PW-915S2](#) [VG2389S433N0S1](#) [VG6244S580X0M1](#) [RC-WLE5-868-HA](#)
[RFM219BW-868S2](#) [E49-900M20S](#) [E01-2G4M27SX](#) [DL-297LDA-S](#) [DL-24PA-C](#) [DL-Si24R1-A](#) [VG3411S433N0S1](#) [HY831S](#) [TR1101](#)
[VG4130S433N0S1](#) [VG4142T868N0M1](#) [VG3411S915N0S1](#) [E310-433T23S](#) [E43-900T13S3](#) [E07-400MM10S](#) [DL-PAN3029-S-915S](#) [DL-](#)
[PAN3029-S-433S](#) [E01C-2G4M11S](#) [DL-PAN3029-S-868S](#) [E70-433MT14S](#) [E03-2G4M10S](#) [E01C-ML01S](#) [E610-433T20S](#) [E610-](#)
[DTU\(433C30\)](#) [E01-2G4M13S](#) [E30-400M20S\(4463\)](#) [E49-400M30S](#) [E31-230T27D](#) [E41-400M20S](#) [E07-900MM10S](#) [E01-2G4M20S1B](#) [E70-](#)
[900T14S](#) [E01C-ML01D](#) [E49-400T30S](#) [E30-170T27D](#) [E62-433T30D](#) [E21-400G30S](#) [E07-900T10S](#) [E04-400M16S](#) [E01-ML01DP4](#) [E610-](#)
[433T30S](#) [E29-400M22S](#)