

DESCRIPTION

The 4435 uses advanced trench technology to provide excellent $R_{DS(ON)}$, low gate charge and operation with gate voltages as low as 4.5V.

GENERAL FEATURES

V_{DSS}	$R_{DS(ON)}$ @-4.5V(Typ)	$R_{DS(ON)}$ @-10V(Typ)	I_D
-30V	20 m Ω	16 m Ω	-10A

- High Power and current handing capability
- RoHS Compliant
- Surface Mount Package

Application

- Battery Switch
- Load switch
- Power management

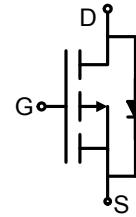

Schematic diagram

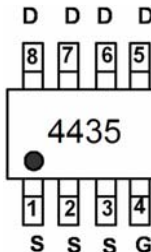

Marking and pin Assignment

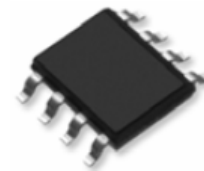

SOP-8

Ordering Information

Part Number	Marking	Case	Packaging
4435	4435	SOP-8	2500pcs/Reel

Absolute Maximum Ratings (TA=25°C unless otherwise noted)

Parameter	Symbol	Limit	Unit
Drain-Source Voltage	V_{DS}	-30	V
Gate-Source Voltage	V_{GS}	±20	V
Drain Current-Continuous	I_D	-10	A
Drain Current-Pulsed (Note 1)	I_{DM}	-50	A
Maximum Power Dissipation	P_D	3.1	W
Operating Junction and Storage Temperature Range	T_J, T_{STG}	-55 To 150	°C

Thermal Characteristic

Thermal Resistance, Junction-to-Ambient (Note 2)	$R_{\theta JA}$	40	°C/W
--	-----------------	----	------

Electrical Characteristics (TA=25°C unless otherwise noted)

Parameter	Symbol	Condition	Min	Typ	Max	Unit
Off Characteristics						
Drain-Source Breakdown Voltage	BV_{DSS}	$V_{GS}=0V, I_D=-250\mu A$	-30	-	-	V

Zero Gate Voltage Drain Current	I_{DSS}	$V_{DS}=-30V, V_{GS}=0V$	-	-	-1	μA
Gate-Body Leakage Current	I_{GSS}	$V_{GS}=\pm 20V, V_{DS}=0V$	-	-	± 100	nA
On Characteristics (Note 3)						
Gate Threshold Voltage	$V_{GS(th)}$	$V_{DS}=V_{GS}, I_D=-250\mu A$	-1	-1.6	-2.5	V
Drain-Source On-State Resistance	$R_{DS(on)}$	$V_{GS}=-10V, I_D=-10A$	-	16	20	m Ω
		$V_{GS}=-4.5V, I_D=-5A$	-	20	33	m Ω
Forward Transconductance	g_{FS}	$V_{DS}=-15V, I_D=-10A$	10	-	-	S
Dynamic Characteristics (Note4)						
Input Capacitance	C_{iss}	$V_{DS}=-15V, V_{GS}=0V,$ $F=1.0MHz$	-	1600	-	PF
Output Capacitance	C_{oss}		-	350	-	PF
Reverse Transfer Capacitance	C_{rss}		-	300	-	PF
Switching Characteristics (Note 4)						
Turn-on Delay Time	$t_{d(on)}$	$V_{DD}=-15V, I_D=-1A,$ $V_{GS}=-10V, R_{GEN}=6\Omega$	-	10	-	nS
Turn-on Rise Time	t_r		-	15	-	nS
Turn-Off Delay Time	$t_{d(off)}$		-	110	-	nS
Turn-Off Fall Time	t_f		-	70	-	nS
Total Gate Charge	Q_g	$V_{DS}=-15V, I_D=-10A$ $V_{GS}=-10V$	-	30	-	nC
Gate-Source Charge	Q_{gs}		-	5.5	-	nC
Gate-Drain Charge	Q_{gd}		-	8	-	nC
Drain-Source Diode Characteristics						
Diode Forward Voltage (Note 3)	V_{SD}	$V_{GS}=0V, I_S=-5A$	-	-	-1.2	

Notes:

1. Repetitive Rating: Pulse width limited by maximum junction temperature.
2. Surface Mounted on FR4 Board, $t \leq 10$ sec.
3. Pulse Test: Pulse Width $\leq 300\mu s$, Duty Cycle $\leq 2\%$.
4. Guaranteed by design, not subject to production

TYPICAL ELECTRICAL AND THERMAL CHARACTERISTICS



Figure 1: Switching Test Circuit

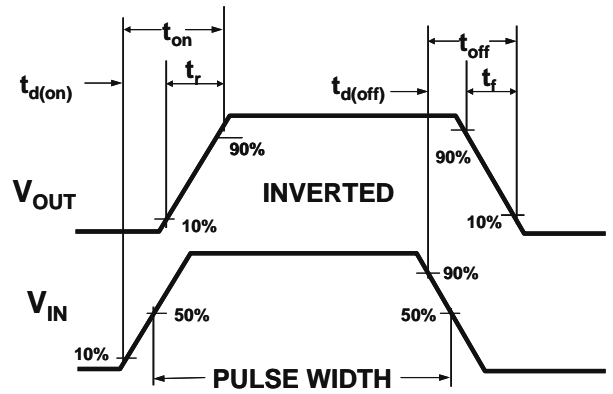

Figure 2: Switching Waveforms

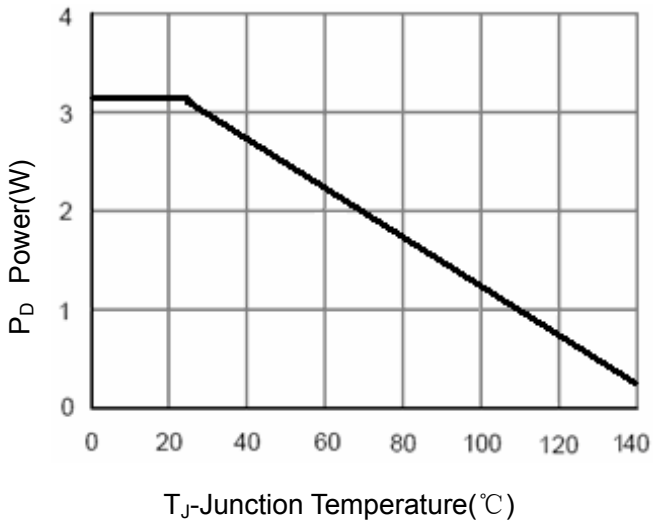

Figure 3 Power Dissipation

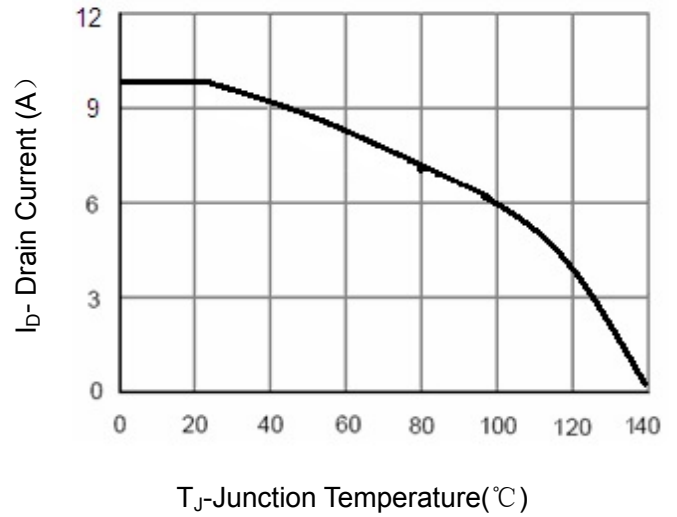

Figure 4 Drain Current

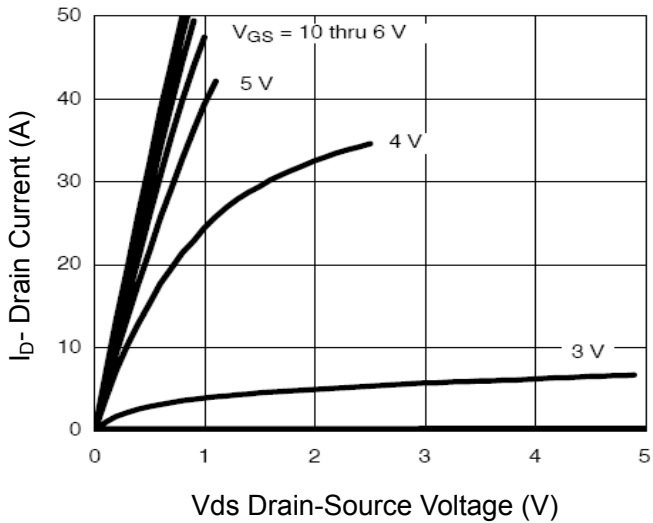

Figure 5 Output CHARACTERISTICS

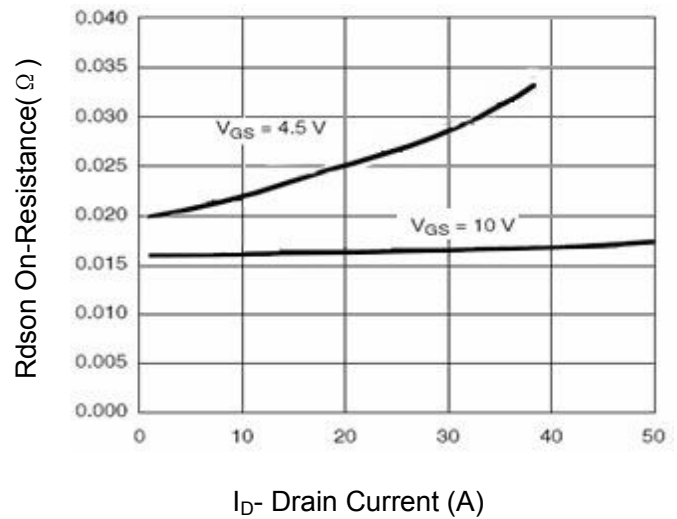

Figure 6 Drain-Source On-Resistance

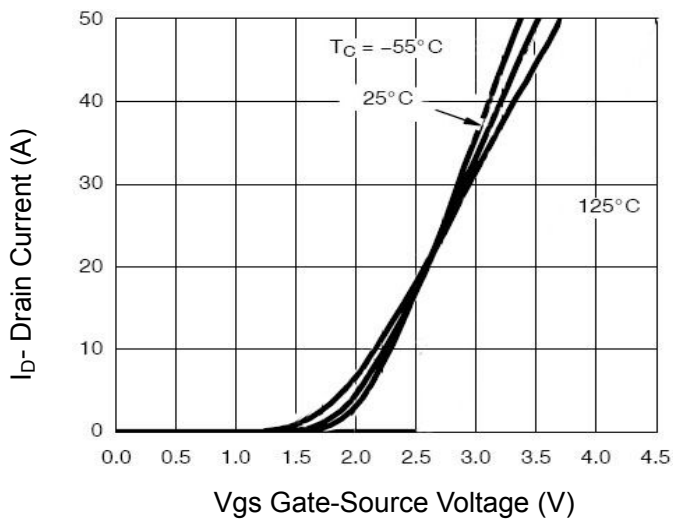

Figure 7 Transfer Characteristics

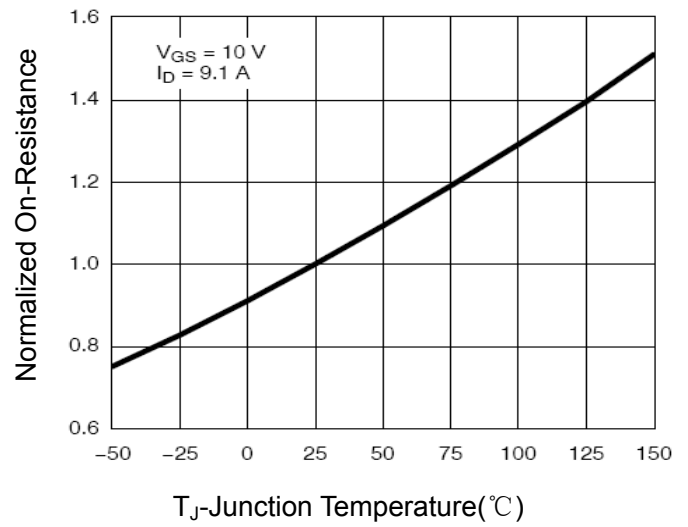

Figure 8 Drain-Source On-Resistance

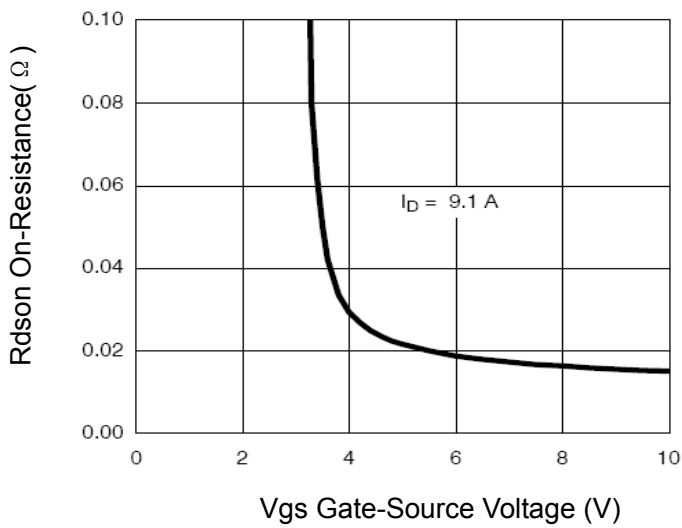

Figure 9 Rdson vs Vgs

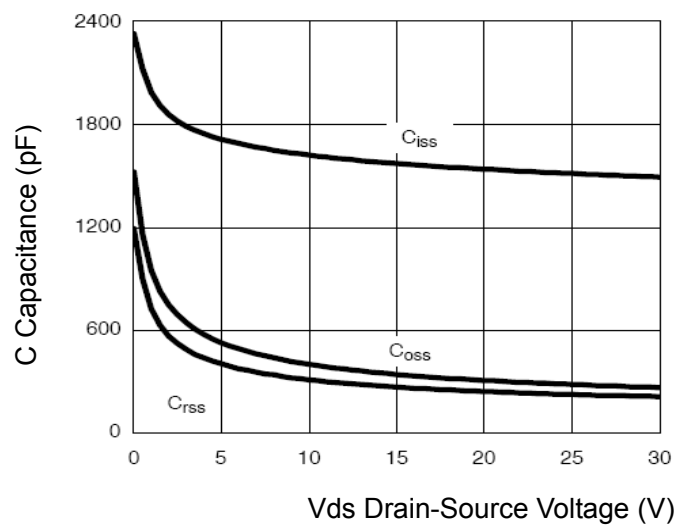

Figure 10 Capacitance vs Vds

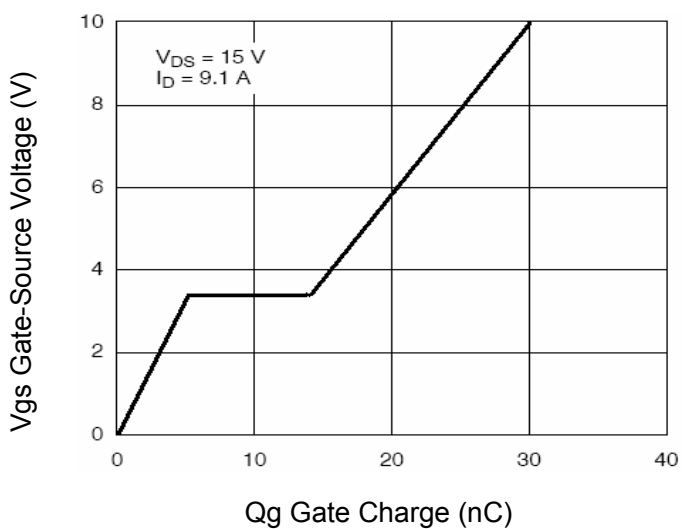

Figure 11 Gate Charge

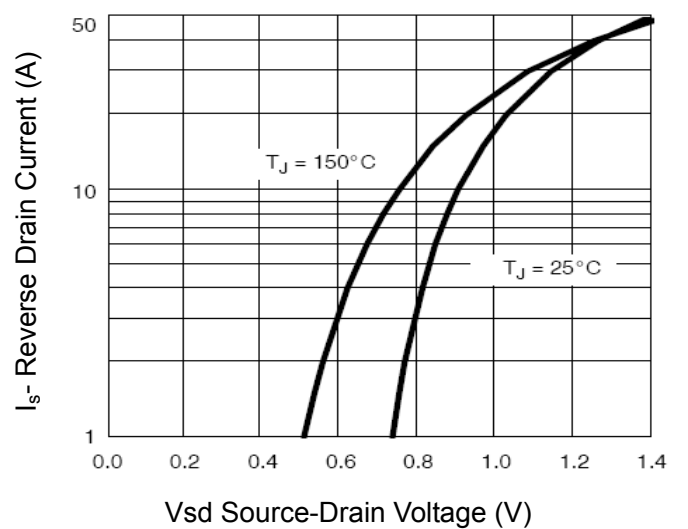

Figure 12 Source- Drain Diode Forward

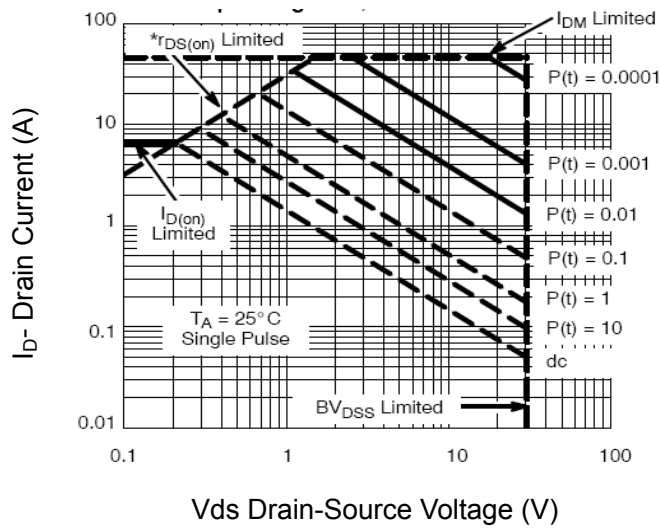

Figure 13 Safe Operation Area

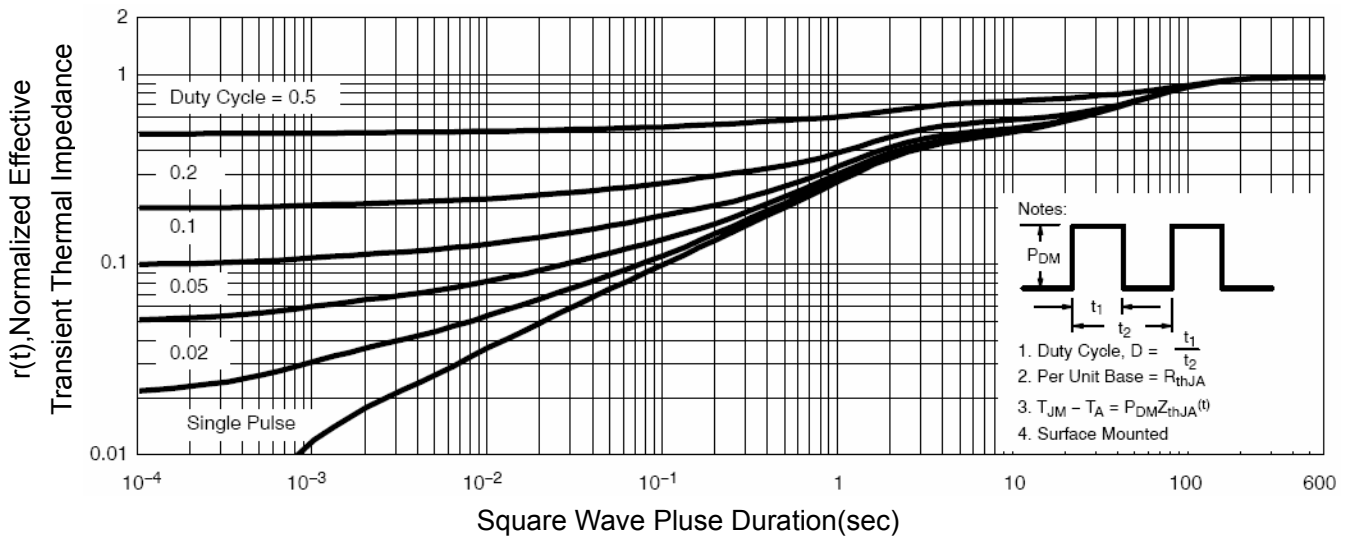
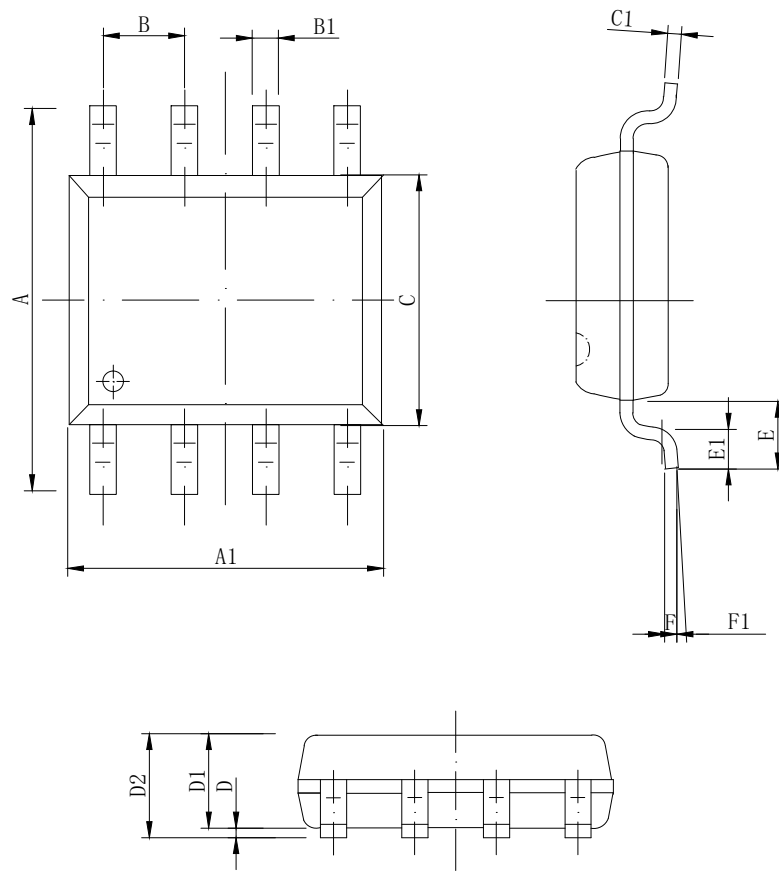

Figure 14 Normalized Maximum Transient Thermal Impedance

SOP-8 Package information



DIM	MIN	NOM	MAX
A	5.800	6.000	6.200
A1	4.800	4.900	5.000
B	1.270BSC		
B1	0.35 ^ 8x	0.40 ^ 8x	0.45 ^ 8x
C	3.780	3.880	3.980
C1	-	0.203	0.253
D	0.050	0.150	0.250
D1	1.350	1.450	1.550
D2	1.500	1.600	1.700
E	1.060 REF		
E1	0.400	0.700	0.100
F	0.250BSC		
F1	2°	4°	6°

All Dimensions in mm

X-ON Electronics

Largest Supplier of Electrical and Electronic Components

Click to view similar products for [MOSFET](#) category:

Click to view products by [GOFORD](#) manufacturer:

Other Similar products are found below :

[614233C](#) [648584F](#) [IRFD120](#) [IRFF430](#) [JANTX2N5237](#) [2N7000](#) [FCA20N60_F109](#) [FDZ595PZ](#) [AOD464](#) [2SK2267\(Q\)](#) [2SK2545\(Q,T\)](#)
[405094E](#) [423220D](#) [MIC4420CM-TR](#) [VN1206L](#) [614234A](#) [715780A](#) [SSM6J414TU,LF\(T](#) [751625C](#) [PSMN4R2-30MLD](#)
[TK31J60W5,S1VQ\(O](#) [2SK2614\(TE16L1,Q\)](#) [DMN1017UCP3-7](#) [EFC2J004NUZTDG](#) [FCAB21350L1](#) [P85W28HP2F-7071](#) [DMN1053UCP4-7](#)
[NTE2384](#) [NTE2969](#) [NTE6400A](#) [DMN2080UCB4-7](#) [DMN61D9UWQ-13](#) [US6M2GTR](#) [DMN31D5UDJ-7](#) [SSM6P54TU,LF](#) [DMP22D4UFO-](#)
[7B](#) [IPS60R3K4CEAKMA1](#) [DMN1006UCA6-7](#) [DMN16M9UCA6-7](#) [STF5N65M6](#) [STU5N65M6](#) [C3M0021120D](#) [DMN13M9UCA6-7](#)
[BSS340NWH6327XTSA1](#) [MCM3400A-TP](#) [DMTH10H4M6SPS-13](#) [IRF40SC240ARMA1](#) [IPS60R1K0PFD7SAKMA1](#)
[IPS60R360PFD7SAKMA1](#) [IPS60R600PFD7SAKMA1](#)