

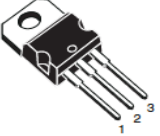
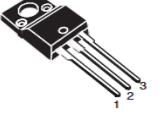
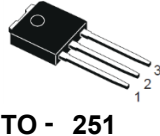

Description

500V N-CHANNEL ENHANCEMENT MODE POWER MOSFET																		
<p>Features</p> <table border="1" style="width: 100%; border-collapse: collapse; margin-bottom: 10px;"> <tr> <td style="padding: 2px;">VDSS</td> <td style="padding: 2px;">$R_{DS(ON)} (Max) @ V_{GS} = 10V$</td> <td style="padding: 2px;">I_D</td> </tr> <tr> <td style="padding: 2px;">500V</td> <td style="padding: 2px;">1.4 Ω</td> <td style="padding: 2px;">5A</td> </tr> </table> <ul style="list-style-type: none"> Fast switching 100% avalanche tested Improved dv/dt capability RoHS Compliant & Halogen-Free 	VDSS	$R_{DS(ON)} (Max) @ V_{GS} = 10V$	I_D	500V	1.4 Ω	5A	<p>Application</p> <ul style="list-style-type: none"> DC Motor Control and Class D Amplifier Uninterruptible Power Supply (UPS) HID 											
VDSS	$R_{DS(ON)} (Max) @ V_{GS} = 10V$	I_D																
500V	1.4 Ω	5A																
<p>Package</p> <div style="display: flex; justify-content: space-around; align-items: flex-start;"> <div style="text-align: center;">  <p>TO - 220</p> </div> <div style="text-align: center;">  <p>TO - 220F</p> </div> </div> <div style="display: flex; justify-content: center; margin: 10px 0;"> <table border="1" style="border-collapse: collapse; text-align: center;"> <thead> <tr> <th>Part Number</th> <th>Package</th> <th>Quantity</th> </tr> </thead> <tbody> <tr> <td>830</td> <td>TO-220</td> <td>50pcs/tube</td> </tr> <tr> <td>830F</td> <td>TO-220F</td> <td>50pcs/tube</td> </tr> <tr> <td>830</td> <td>TO-251</td> <td>72pcs/tube</td> </tr> <tr> <td>830</td> <td>TO-252</td> <td>2500pcs/reel</td> </tr> </tbody> </table> </div> <div style="display: flex; justify-content: space-around; align-items: flex-start;"> <div style="text-align: center;">  <p>TO - 251</p> </div> <div style="text-align: center;">  <p>TO - 252</p> </div> </div> <div style="text-align: right; margin-top: 20px;">  </div>				Part Number	Package	Quantity	830	TO-220	50pcs/tube	830F	TO-220F	50pcs/tube	830	TO-251	72pcs/tube	830	TO-252	2500pcs/reel
Part Number	Package	Quantity																
830	TO-220	50pcs/tube																
830F	TO-220F	50pcs/tube																
830	TO-251	72pcs/tube																
830	TO-252	2500pcs/reel																

Absolute Maximum Ratings $T_C=25^\circ C$ unless otherwise specified

Symbol	Parameter	Max.			Units	
		TO-220	TO220F	TO251 TO252		
V_{DSS}	Drain-Source Voltage	500			V	
V_{GSS}	Gate-Source Voltage	± 30			V	
I_D	Continuous Drain Current	$T_C = 25^\circ C$	5	5*	5*	A
		$T_C = 100^\circ C$	3.2	3.2*	3.2*	A
I_{DM}	Pulsed Drain Current ^{note1}	20	20*	20*	A	
E_{AS}	Single Pulsed Avalanche Energy ^{note2}	150			mJ	
P_D	Power Dissipation	$T_C = 25^\circ C$	100	33	45	W
	Linear Derating Factor	$T_C > 25^\circ C$	0.8	0.27	0.36	W/ $^\circ C$
$R_{\theta JC}$	Thermal Resistance, Junction to Case	1.25	3.75	2.8	$^\circ C/W$	
T_J, T_{STG}	Operating and Storage Temperature Range	-55 to +150			$^\circ C$	

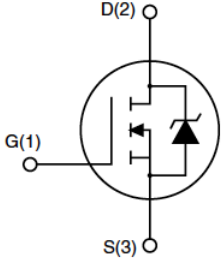
*Drain current limited by maximum junction temperature

Electrical Characteristics $T_C=25^\circ\text{C}$ unless otherwise specified

Symbol	Parameter	Test Condition	Min.	Typ.	Max.	Units
Off Characteristics						
$V_{(BR)DSS}$	Drain-Source Breakdown Voltage	$V_{GS} = 0V, I_D = 250\mu A$	500	-	-	V
$\Delta V_{(BR)DSS} / \Delta T_J$	Breakdown Voltage Temperature Coefficient	Reference to 25°C , $I_D = 250\mu A$	-	0.5	-	$V/^\circ\text{C}$
I_{DSS}	Zero Gate Voltage Drain Current	$V_{DS} = 500V, V_{GS} = 0V$	-	-	1	μA
		$V_{DS} = 400V, T_C = 125^\circ\text{C}$	-	-	10	μA
I_{GSS}	Gate to Body Leakage Current	$V_{DS} = 0V, V_{GS} = \pm 30V$	-	-	± 100	nA
On Characteristics						
$V_{GS(th)}$	Gate Threshold Voltage ^{note4}	$V_{DS} = V_{GS}, I_D = 250\mu A$	2	-	4	V
$R_{DS(on)}$	Static Drain-Source On-Resistance	$V_{GS} = 10V, I_D = 2.5A$	-	-	1.4	Ω
g_{FS}	Forward Transconductance	$V_{DS} = 30V, I_D = 2.5A$	-	3.0	-	S
Dynamic Characteristics						
C_{iss}	Input Capacitance	$V_{DS} = 25V, V_{GS} = 0V,$ $f = 1.0\text{MHz}$	-	586	-	pF
C_{oss}	Output Capacitance		-	58.8	-	pF
C_{rss}	Reverse Transfer Capacitance		-	3.2	-	pF
Q_g	Total Gate Charge	$V_{DD} = 400V, I_D = 5A,$ $V_{GS} = 10V$	-	13.4	-	nC
Q_{gs}	Gate-Source Charge		-	2.77	-	nC
Q_{gd}	Gate-Drain("Miller") Charge		-	4.43	-	nC
Switching Characteristics						
$t_{d(on)}$	Turn-On Delay Time	$V_{DD} = 250V, I_D = 5A,$ $R_G = 10\Omega, V_{GS} = 10V$	-	12.1	-	ns
t_r	Turn-On Rise Time		-	11.5	-	ns
$t_{d(off)}$	Turn-Off Delay Time		-	33.3	-	ns
t_f	Turn-Off Fall Time		-	7.33	-	ns
Drain-Source Diode Characteristics and Maximum Ratings						
I_S	Maximum Continuous Drain to Source Diode Forward Current		-	-	5	A
I_{SM}	Maximum Pulsed Drain to Source Diode Forward Current		-	-	20	A
V_{SD}	Drain to Source Diode Forward Voltage	$V_{GS} = 0V, I_S = 5A$	-	-	1.4	V
t_{rr}	Reverse Recovery Time	$V_{GS} = 0V, I_F = 5A,$ $di/dt = 100A/\mu s$	-	387	-	ns
Q_{rr}	Reverse Recovery Charge		-	1.5	-	μC

Notes:

1. Repetitive Rating: Pulse width limited by maximum junction temperature
2. $L = 10\text{mH}, I_{AS} = 6A, V_{DD} = 50V, R_G = 25\Omega$, Starting $T_J = 25^\circ\text{C}$
3. $I_{SD} \leq 5A, di/dt \leq 200A/\mu s, V_{DD} \leq B_{VDSS}$, Starting $T_J = 25^\circ\text{C}$
4. Pulse width $\leq 300\mu s$; duty cycle $\leq 2\%$.

Typical Performance Characteristics

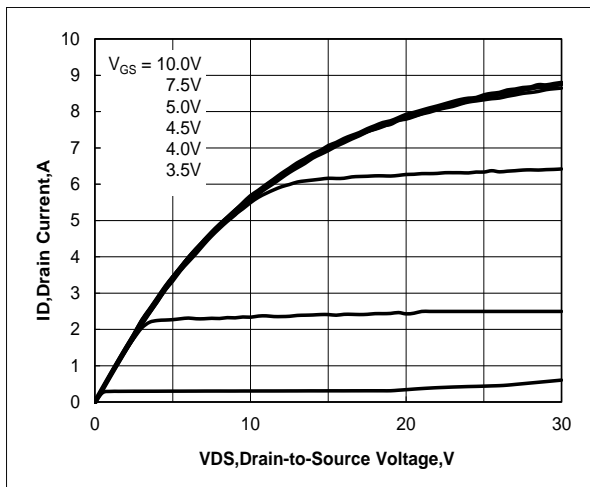

Figure 1. Output Characteristics

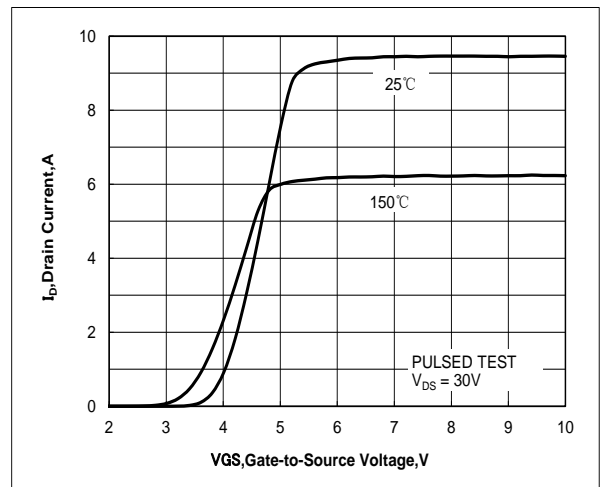

Figure 2. Transfer Characteristics

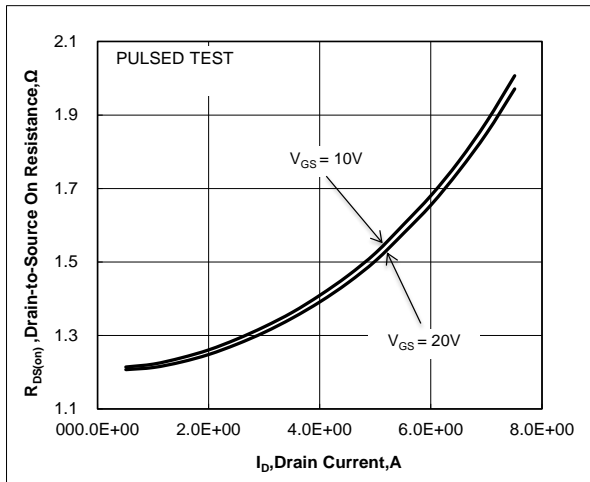

Figure 3. Drain-to-Source On Resistance vs. Drain Current and Gate Voltage

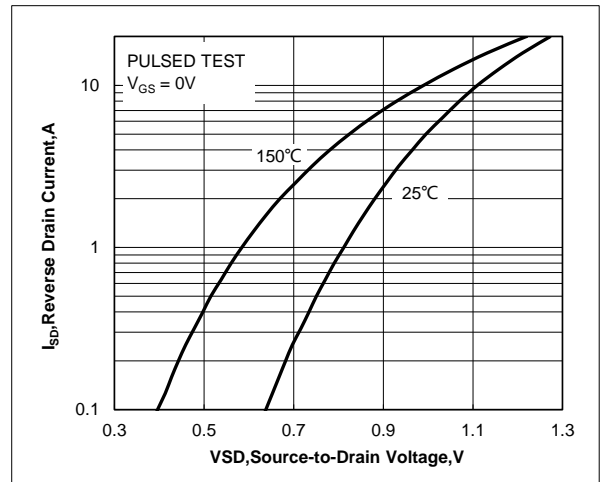

Figure 4. Body Diode Forward Voltage vs. Source Current and Temperature

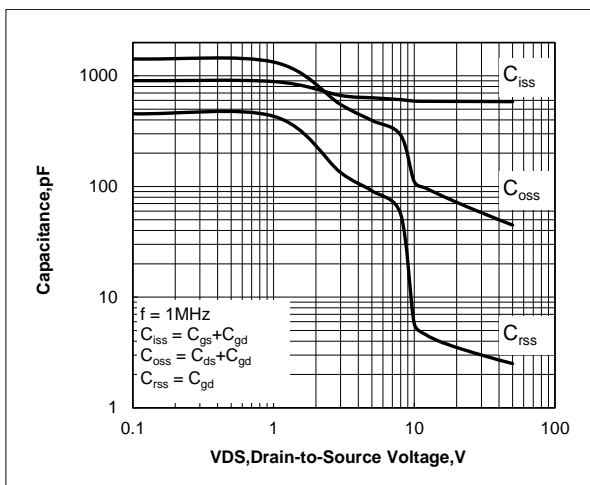

Figure 5. Capacitance Characteristics

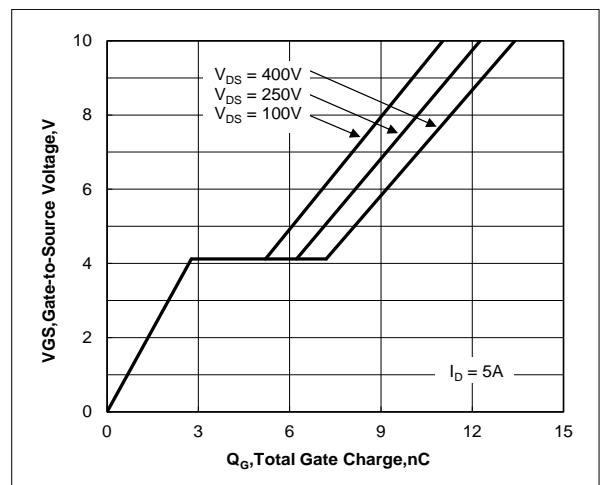

Figure 6. Gate Charge Characteristics

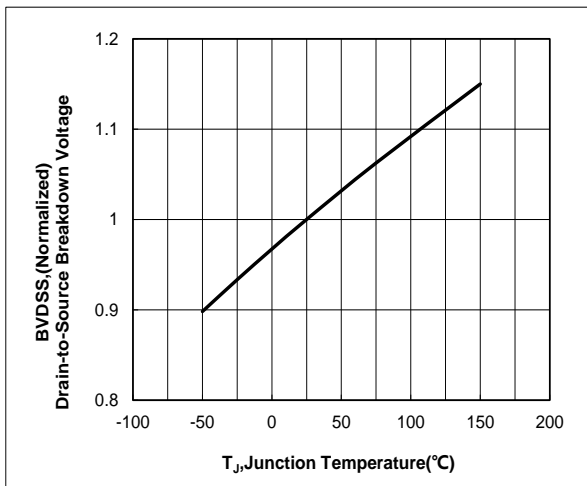

Figure 7. Normalized Breakdown Voltage vs. Junction Temperature

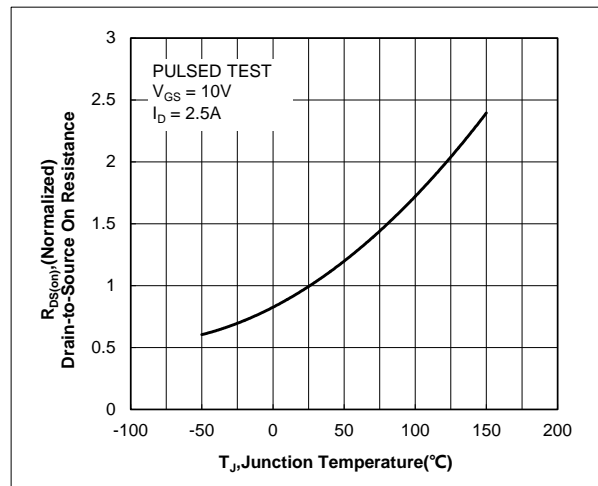

Figure 8. Normalized On Resistance vs. Junction Temperature

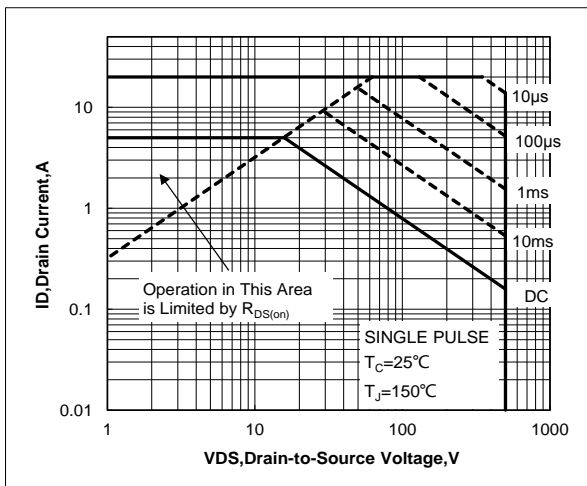

Figure 9. Maximum Safe Operating Area

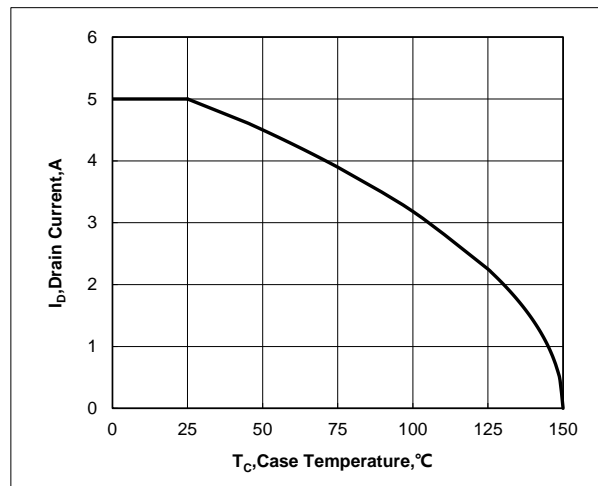

Figure 10. Maximum Continuous Drain Current vs. Case Temperature

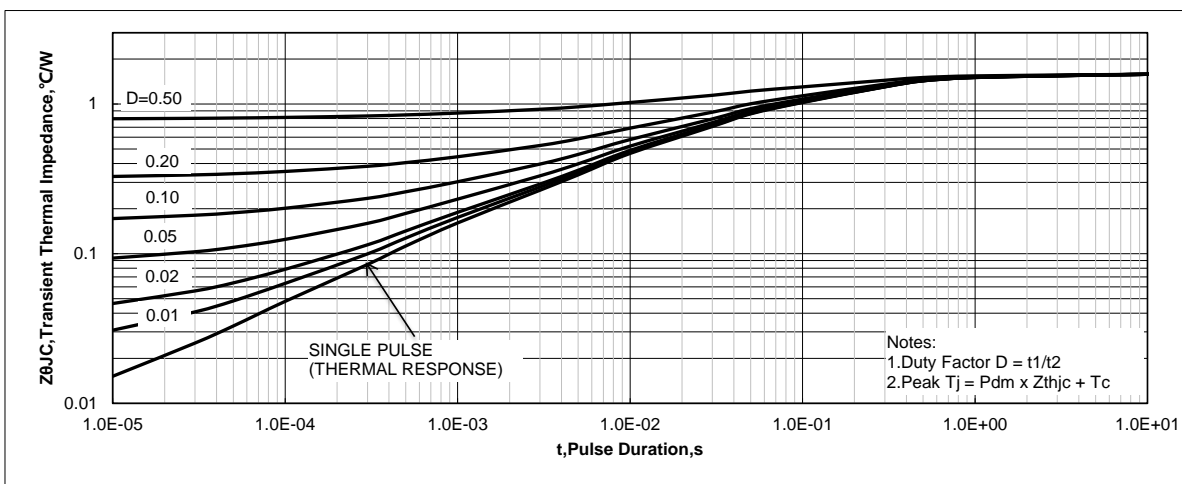

Figure 11. Maximum Effective Transient Thermal Impedance, Junction-to-Case

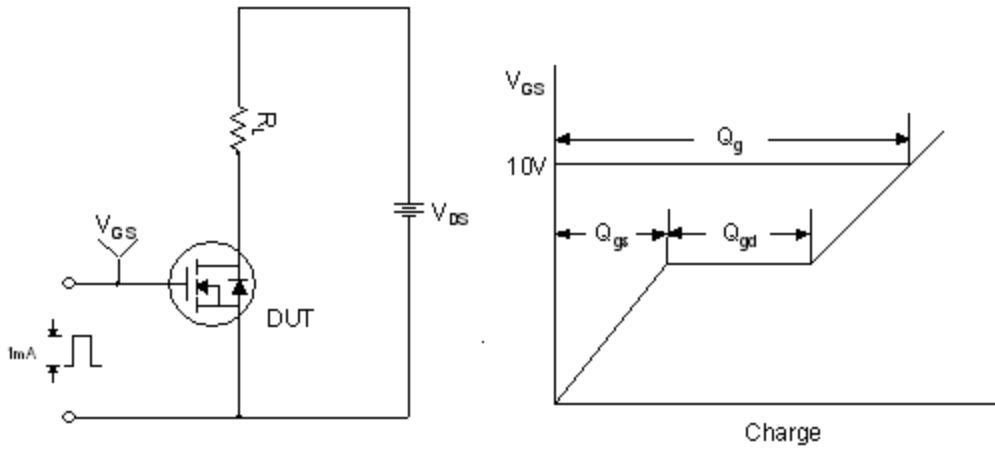

Figure 12. Gate Charge Test Circuit & Waveform

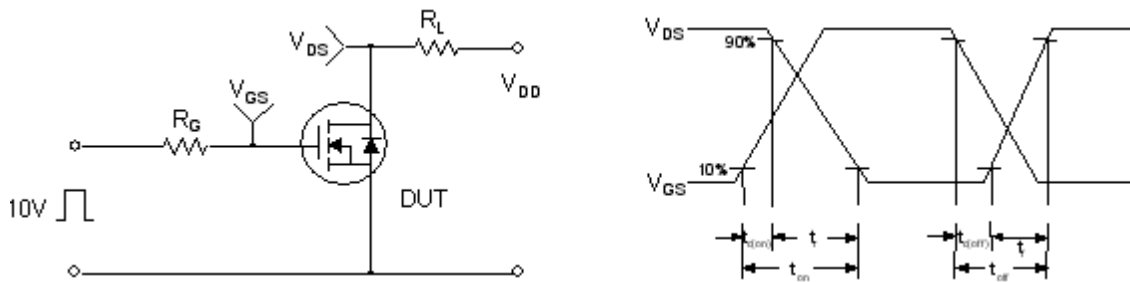

Figure 13. Resistive Switching Test Circuit & Waveforms

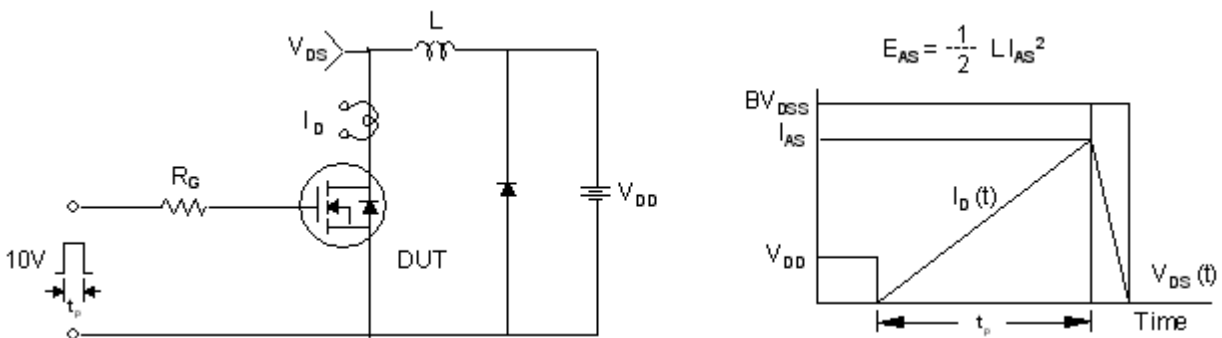

Figure 14. Unclamped Inductive Switching Test Circuit & Waveforms

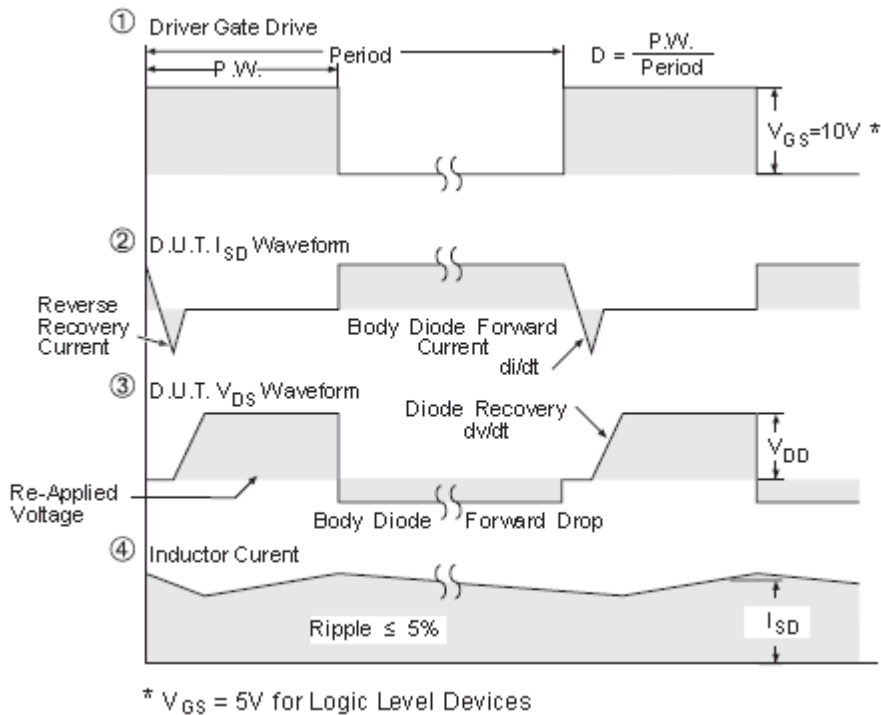
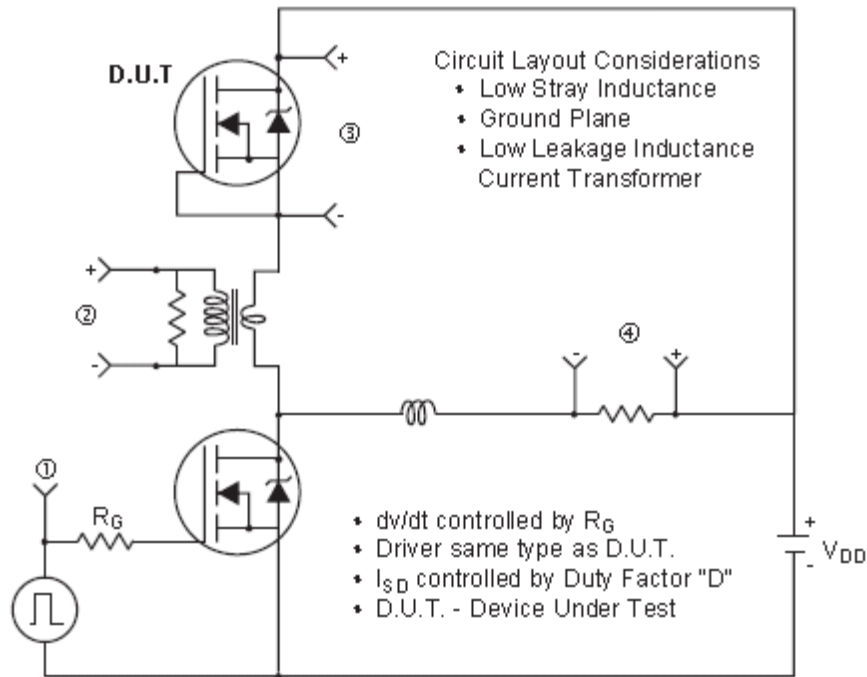

Figure 15. Peak Diode Recovery dv/dt Test Circuit & Waveforms (For N-channel)

X-ON Electronics

Largest Supplier of Electrical and Electronic Components

Click to view similar products for [MOSFET](#) category:

Click to view products by [GOFORD](#) manufacturer:

Other Similar products are found below :

[IRFD120](#) [JANTX2N5237](#) [BUK455-60A/B](#) [MIC4420CM-TR](#) [VN1206L](#) [NDP4060](#) [SI4482DY](#) [IPS70R2K0CEAKMA1](#) [SQD23N06-31L-GE3](#)
[TK16J60W,S1VQ\(O](#) [2SK2614\(TE16L1,Q\)](#) [DMN1017UCP3-7](#) [DMN1053UCP4-7](#) [SQJ469EP-T1-GE3](#) [NTE2384](#) [DMC2700UDMQ-7](#)
[DMN2080UCB4-7](#) [DMN61D9UWQ-13](#) [US6M2GTR](#) [DMN31D5UDJ-7](#) [DMP22D4UFO-7B](#) [DMN1006UCA6-7](#) [DMN16M9UCA6-7](#)
[STF5N65M6](#) [IRF40H233XTMA1](#) [STU5N65M6](#) [DMN6022SSD-13](#) [DMN13M9UCA6-7](#) [DMTH10H4M6SPS-13](#) [DMN2990UFB-7B](#)
[IPB80P04P405ATMA2](#) [2N7002W-G](#) [MCAC30N06Y-TP](#) [MCQ7328-TP](#) [BXP7N65D](#) [BXP4N65F](#) [AOL1454G](#) [WMJ80N60C4](#) [BXP2N20L](#)
[BXP2N65D](#) [BXT1150N10J](#) [BXT1700P06M](#) [TSM60NB380CP](#) [ROG](#) [RQ7L055BGTCR](#) [DMNH15H110SK3-13](#) [SLF10N65ABV2](#)
[BSO203SP](#) [BSO211P](#) [IPA60R230P6](#) [IPA60R460CE](#)