

## P-Channel Enhancement Mode Power MOSFET

### Description

The G04P10HE uses advanced trench technology to provide excellent  $R_{DS(ON)}$ , low gate charge. It can be used in a wide variety of applications.

### General Features

- $V_{DS}$  -100V
- $I_D$  (at  $V_{GS} = -10V$ ) -4A
- $R_{DS(ON)}$  (at  $V_{GS} = -10V$ ) < 200m $\Omega$
- $R_{DS(ON)}$  (at  $V_{GS} = -4.5V$ ) < 250m $\Omega$
- 100% Avalanche Tested
- RoHS Compliant
- ESD (HBM)>6KV

### Application

- Power switch
- DC/DC converters

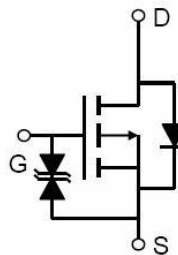

Schematic diagram



SOT-223

### Ordering Information

Device	Package	Marking	Packaging
G04P10HE	SOT-223	G04P10	2500pcs/Reel

### Absolute Maximum Ratings $T_C = 25^\circ C$ , unless otherwise noted

Parameter	Symbol	Value	Unit
Drain-Source Voltage	$V_{DS}$	-100	V
Continuous Drain Current	$I_D$	-4	A
Pulsed Drain Current (note1)	$I_{DM}$	-16	A
Gate-Source Voltage	$V_{GS}$	$\pm 20$	V
Power Dissipation	$P_D$	1.2	W
Operating Junction and Storage Temperature Range	$T_J, T_{stg}$	-55 To 150	$^\circ C$

### Thermal Resistance

Parameter	Symbol	Value	Unit
Thermal Resistance, Junction-to-Ambient	$R_{thJA}$	100	$^\circ C/W$

Specifications $T_J = 25^\circ\text{C}$ , unless otherwise noted						
Parameter	Symbol	Test Conditions	Value			Unit
			Min.	Typ.	Max.	
<b>Static Parameters</b>						
Drain-Source Breakdown Voltage	$V_{(BR)DSS}$	$V_{GS} = 0V, I_D = -250\mu A$	-100	--	--	V
Zero Gate Voltage Drain Current	$I_{DSS}$	$V_{DS} = -100V, V_{GS} = 0V$	--	--	-1	$\mu A$
Gate-Source Leakage	$I_{GSS}$	$V_{GS} = \pm 20V$	--	--	$\pm 10$	$\mu A$
Gate-Source Threshold Voltage	$V_{GS(th)}$	$V_{DS} = V_{GS}, I_D = -250\mu A$	-1.2	-1.55	-2.8	V
Drain-Source On-Resistance	$R_{DS(on)}$	$V_{GS} = -10V, I_D = -6A$	--	177	200	m $\Omega$
		$V_{GS} = -4.5V, I_D = -6A$	--	190	250	
Forward Transconductance	$g_{FS}$	$V_{DS} = -5V, I_D = -3A$	--	10	--	S
<b>Dynamic Parameters</b>						
Input Capacitance	$C_{iss}$	$V_{GS} = 0V,$ $V_{DS} = -50V,$ $f = 1.0MHz$	--	1647	--	pF
Output Capacitance	$C_{oss}$		--	43	--	
Reverse Transfer Capacitance	$C_{rss}$		--	42	--	
Total Gate Charge	$Q_g$	$V_{DD} = -50V,$ $I_D = -4A,$ $V_{GS} = -10V$	--	25	--	nC
Gate-Source Charge	$Q_{gs}$		--	5	--	
Gate-Drain Charge	$Q_{gd}$		--	7	--	
Turn-on Delay Time	$t_{d(on)}$	$V_{DD} = -50V,$ $I_D = -4A,$ $R_G = 9\Omega$	--	14	--	ns
Turn-on Rise Time	$t_r$		--	18	--	
Turn-off Delay Time	$t_{d(off)}$		--	50	--	
Turn-off Fall Time	$t_f$		--	18	--	
<b>Drain-Source Body Diode Characteristics</b>						
Continuous Body Diode Current	$I_S$	$T_C = 25^\circ\text{C}$	--	--	-4	A
Body Diode Voltage	$V_{SD}$	$T_J = 25^\circ\text{C}, I_{SD} = -6A, V_{GS} = 0V$	--	--	-1.2	V
Reverse Recovery Charge	$Q_{rr}$	$I_F = -4A, V_{GS} = 0V$ $di/dt = -100A/\mu s$	--	46	--	nC
Reverse Recovery Time	$T_{rr}$		--	35	--	ns

### Notes

1. Repetitive Rating: Pulse width limited by maximum junction temperature
2. Identical low side and high side switch with identical  $R_G$

### Gate Charge Test Circuit

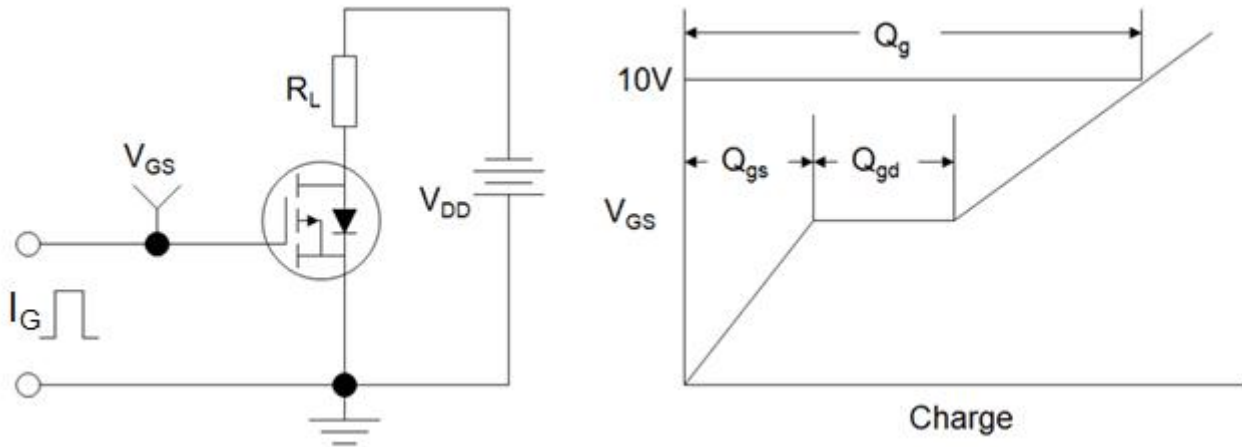

### Switch Time Test Circuit



### EAS Test Circuit

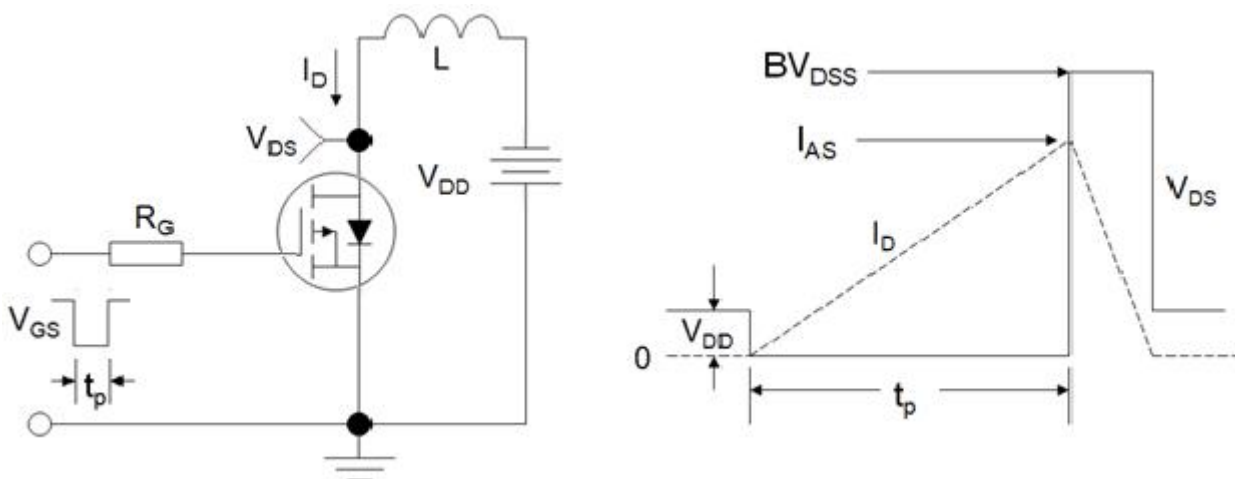

Typical Characteristics  $T_J = 25^\circ\text{C}$ , unless otherwise noted

Figure 1. Output Characteristics

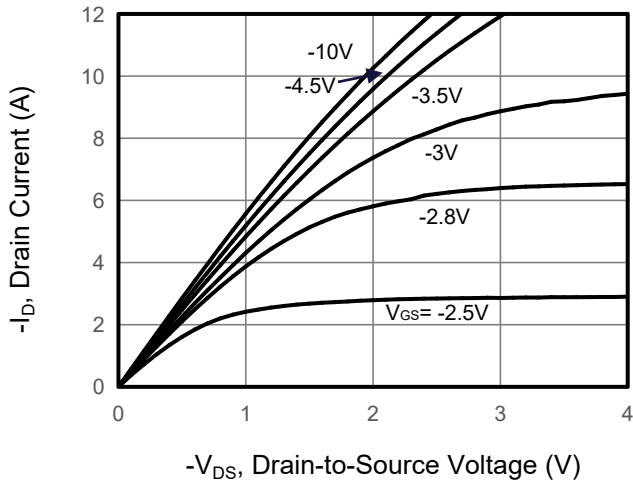

Figure 2. Transfer Characteristics

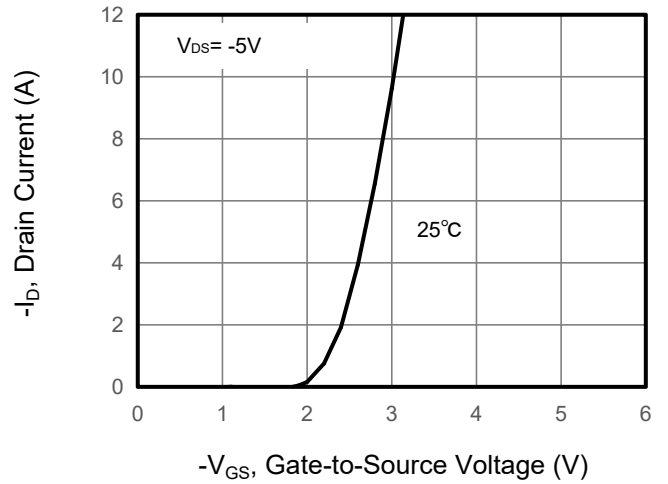

Figure 3. Drain Source On Resistance

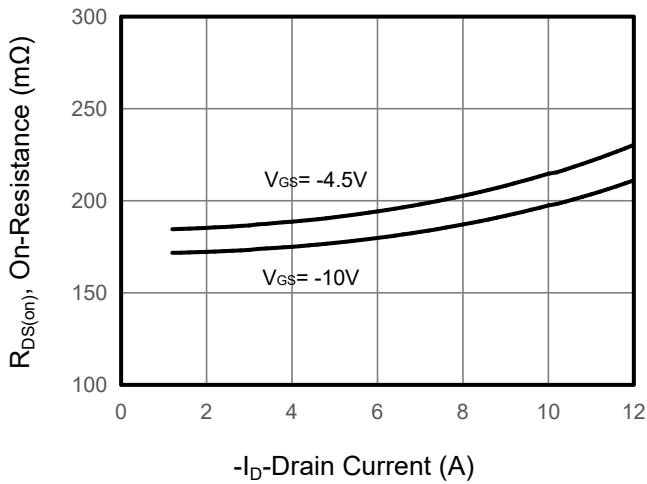

Figure 4. Gate Charge

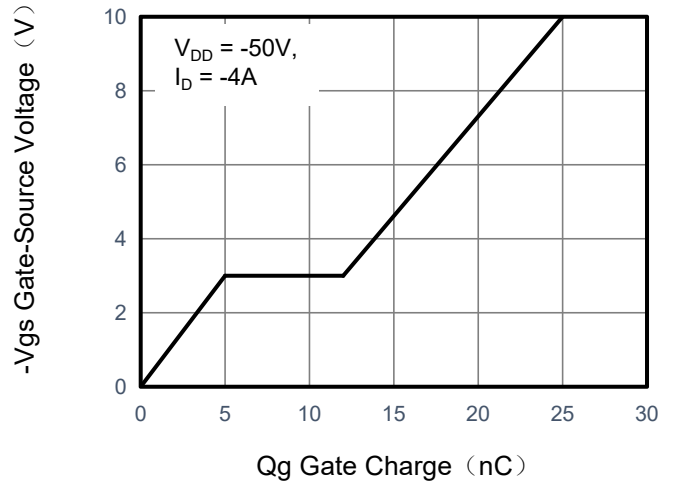

Figure 5. Capacitance

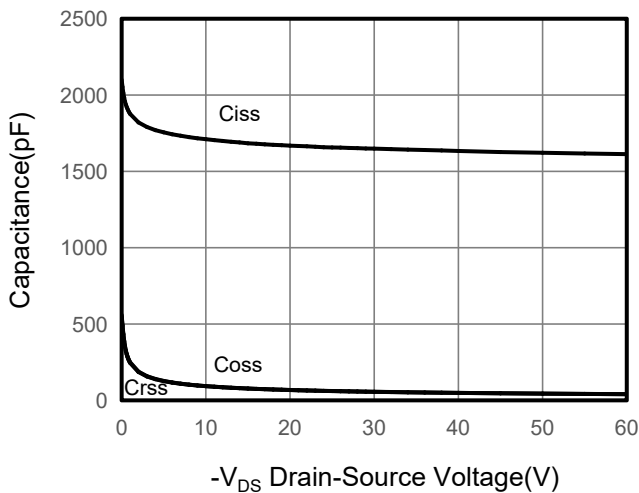
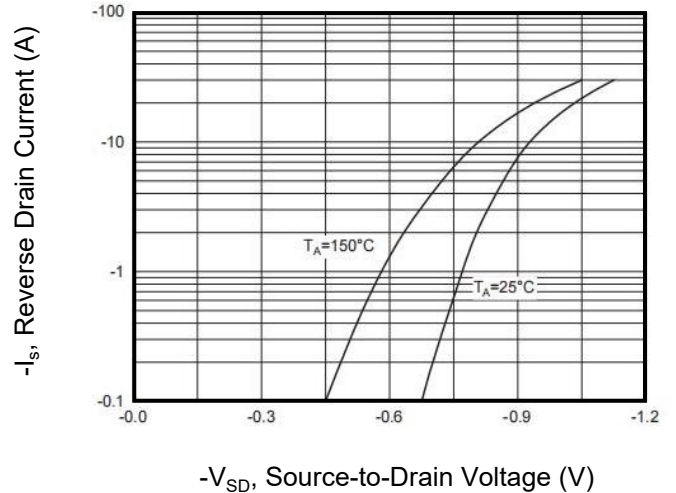

Figure 6. Source-Drain Diode Forward



## Typical Characteristics $T_J = 25^\circ\text{C}$ , unless otherwise noted

Figure 7. Drain-Source On-Resistance

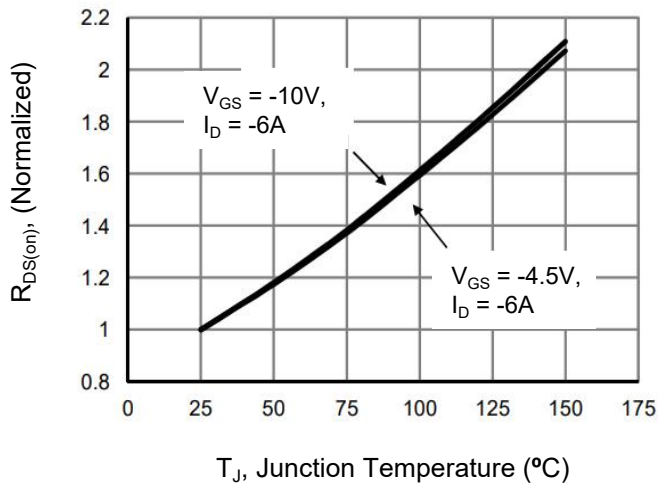

Figure 10. Safe Operation Area

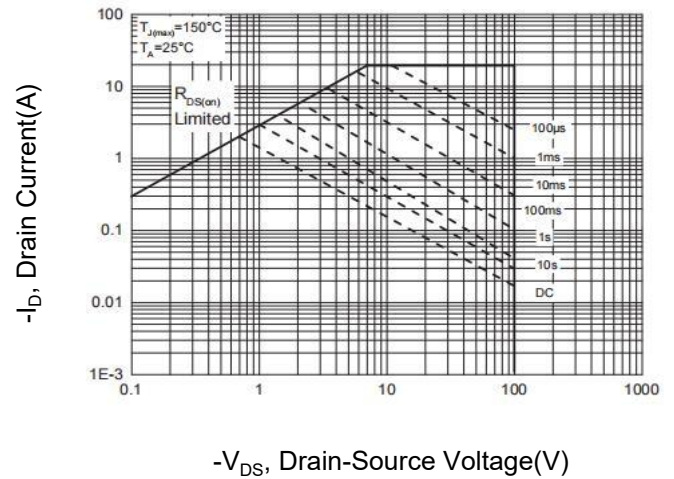
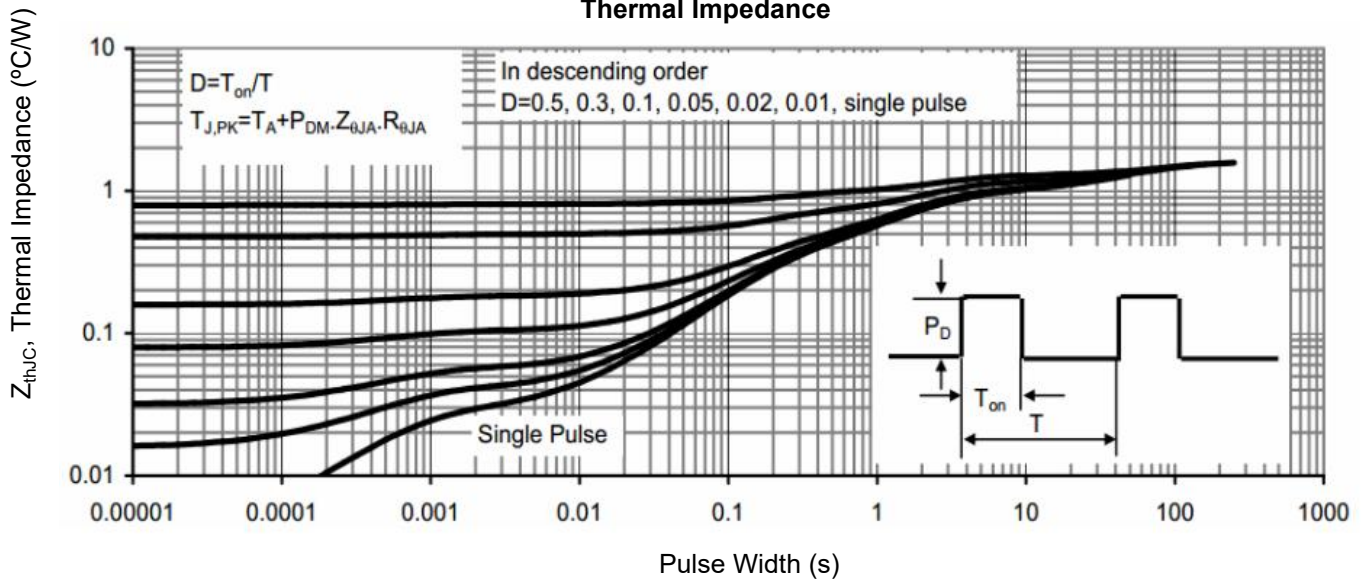
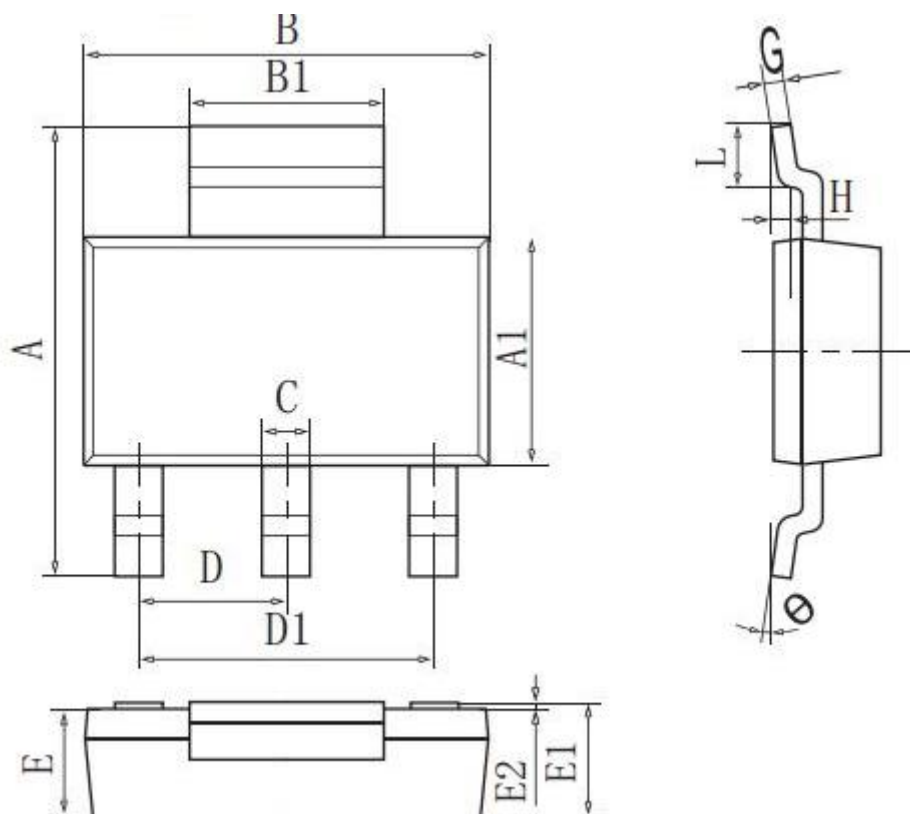

Figure 9. Normalized Maximum Transient Thermal Impedance



## SOT-223 Package Mechanical Data



DIM	MIN	NOM	MAX
A	6.80	7.00	7.20
A1	3.30	3.50	3.70
B	6.40	6.60	6.80
B1	2.96	3.00	3.10
C	0.66	0.70	0.80
D	2.25	2.30	2.35
D1	4.60REF		
E	1.50	1.60	1.70
E1	1.65REF		
E2	0.02	0.06	0.10
G	0.255	0.305	0.355
H	0.25GAUGR		
L	0.90	-	-
θ	0°	-	10°
All Dimensions in mm			

## X-ON Electronics

Largest Supplier of Electrical and Electronic Components

*Click to view similar products for [MOSFET](#) category:*

*Click to view products by [GOFORD](#) manufacturer:*

Other Similar products are found below :

[IRFD120](#) [JANTX2N5237](#) [2SK2267\(Q\)](#) [BUK455-60A/B](#) [TK100A10N1,S4X\(S](#) [MIC4420CM-TR](#) [VN1206L](#) [NDP4060](#) [SI4482DY](#)  
[IRS2092STRPBF-EL](#) [IPS70R2K0CEAKMA1](#) [TK31J60W5,S1VQ\(O](#) [TK31J60W,S1VQ\(O](#) [TK16J60W,S1VQ\(O](#) [2SK2614\(TE16L1,Q\)](#)  
[DMN1017UCP3-7](#) [EFC2J004NUZTDG](#) [P85W28HP2F-7071](#) [NTE2384](#) [DMC2700UDMQ-7](#) [DMN2080UCB4-7](#) [DMN61D9UWQ-13](#)  
[US6M2GTR](#) [DMN31D5UDJ-7](#) [DMP22D4UFO-7B](#) [IPS60R3K4CEAKMA1](#) [DMN1006UCA6-7](#) [DMN16M9UCA6-7](#) [STF5N65M6](#)  
[IRF40H233XTMA1](#) [STU5N65M6](#) [DMN6022SSD-13](#) [DMN13M9UCA6-7](#) [DMTH10H4M6SPS-13](#) [IPS60R360PFD7SAKMA1](#)  
[DMN2990UFB-7B](#) [SSM3K35CT,L3F](#) [IPLK60R1K0PFD7ATMA1](#) [2N7002W-G](#) [MCAC30N06Y-TP](#) [IPWS65R035CFD7AXKSA1](#)  
[MCQ7328-TP](#) [SSM3J143TU,LXHF](#) [DMN12M3UCA6-7](#) [PJMF280N65E1\\_T0\\_00201](#) [PJMF380N65E1\\_T0\\_00201](#)  
[PJMF280N60E1\\_T0\\_00201](#) [PJMF600N65E1\\_T0\\_00201](#) [PJMF900N65E1\\_T0\\_00201](#) [PJMF900N60E1\\_T0\\_00201](#)