

Description

The G120N04A uses advanced trench technology and design to provide excellent $R_{DS(ON)}$ with low gate charge. It can be used in a wide variety of applications.

General Features

- | V_{DSS} | $R_{DS(ON)}$
@4.5V(Typ) | $R_{DS(ON)}$
@10V(Typ) | I_D |
|-----------|----------------------------|---------------------------|-------|
| 40V | 5.5m Ω | 3.2m Ω | 120A |
- High density cell design for ultra low R_{dson}
- Fully characterized avalanche voltage and current
- Good stability and uniformity with high E_{AS}
- Excellent package for good heat dissipation
- Special process technology for high ESD capability

Application

- Load switching
- Hard switched and high frequency circuits
- Uninterruptible power supply

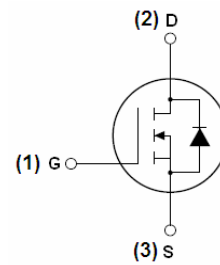

Schematic diagram

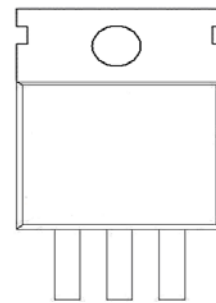

Marking and pin assignment



TO-220

Absolute Maximum Ratings ($T_C=25^\circ\text{C}$ unless otherwise noted)

Parameter	Symbol	Limit	Unit
Drain-Source Voltage	V_{DS}	40	V
Gate-Source Voltage	V_{GS}	± 20	V
Drain Current-Continuous	I_D	120	A
Drain Current-Continuous($T_C=100^\circ\text{C}$)	$I_D(100^\circ\text{C})$	85	A
Pulsed Drain Current	I_{DM}	330	A
Maximum Power Dissipation	P_D	130	W
Derating factor		0.87	W/ $^\circ\text{C}$
Single pulse avalanche energy ^(Note 5)	E_{AS}	1080	mJ
Operating Junction and Storage Temperature Range	T_J, T_{STG}	-55 To 175	$^\circ\text{C}$

Thermal Characteristic

Thermal Resistance, Junction-to-Case ^(Note 2)	$R_{\theta JC}$	1.15	°C/W
--	-----------------	------	------

Electrical Characteristics ($T_C=25^\circ\text{C}$ unless otherwise noted)

Parameter	Symbol	Condition	Min	Typ	Max	Unit
Off Characteristics						
Drain-Source Breakdown Voltage	BV_{DSS}	$V_{GS}=0V, I_D=250\mu A$	40	45	-	V
Zero Gate Voltage Drain Current	I_{DSS}	$V_{DS}=40V, V_{GS}=0V$	-	-	1	μA
Gate-Body Leakage Current	I_{GSS}	$V_{GS}=\pm 20V, V_{DS}=0V$	-	-	± 100	nA
On Characteristics ^(Note 3)						
Gate Threshold Voltage	$V_{GS(th)}$	$V_{DS}=V_{GS}, I_D=250\mu A$	1.2	1.9	2.5	V
Drain-Source On-State Resistance	$R_{DS(on)}$	$V_{GS}=10V, I_D=20A$	-	3.2	4.0	m Ω
		$V_{GS}=4.5V, I_D=10A$	-	5.5	7.0	
Forward Transconductance	g_{FS}	$V_{DS}=10V, I_D=20A$	26	-	-	S
Dynamic Characteristics ^(Note 4)						
Input Capacitance	C_{iss}	$V_{DS}=20V, V_{GS}=0V,$ $F=1.0\text{MHz}$	-	5400	-	PF
Output Capacitance	C_{oss}		-	970	-	PF
Reverse Transfer Capacitance	C_{rss}		-	380	-	PF
Switching Characteristics ^(Note 4)						
Turn-on Delay Time	$t_{d(on)}$	$V_{DD}=20V, I_D=2A, R_L=1\Omega$ $V_{GS}=10V, R_G=3\Omega$	-	15	-	nS
Turn-on Rise Time	t_r		-	18	-	nS
Turn-Off Delay Time	$t_{d(off)}$		-	52	-	nS
Turn-Off Fall Time	t_f		-	23	-	nS
Total Gate Charge	Q_g	$V_{DS}=20V, I_D=20A,$ $V_{GS}=10V$	-	75	-	nC
Gate-Source Charge	Q_{gs}		-	10.5	-	nC
Gate-Drain Charge	Q_{gd}		-	17	-	nC
Drain-Source Diode Characteristics						
Diode Forward Voltage ^(Note 3)	V_{SD}	$V_{GS}=0V, I_S=40A$	-	-	1.2	V
Diode Forward Current ^(Note 2)	I_S		-	-	120	A
Reverse Recovery Time	t_{rr}	$T_J = 25^\circ\text{C}, I_F = 40A$ $di/dt = 100A/\mu s$ ^(Note 3)	-	42	-	nS
Reverse Recovery Charge	Q_{rr}		-	45	-	nC
Forward Turn-On Time	t_{on}	Intrinsic turn-on time is negligible (turn-on is dominated by LS+LD)				

Notes:

1. Repetitive Rating: Pulse width limited by maximum junction temperature.
2. Surface Mounted on FR4 Board, $t \leq 10$ sec.
3. Pulse Test: Pulse Width $\leq 300\mu s$, Duty Cycle $\leq 2\%$.
4. Guaranteed by design, not subject to production
5. E_{AS} condition : $T_J=25^\circ\text{C}, V_{DD}=20V, V_G=10V, L=1\text{mH}, R_g=25\Omega, I_{AS}=46.5A$

Test circuit

1) E_{AS} Test Circuit

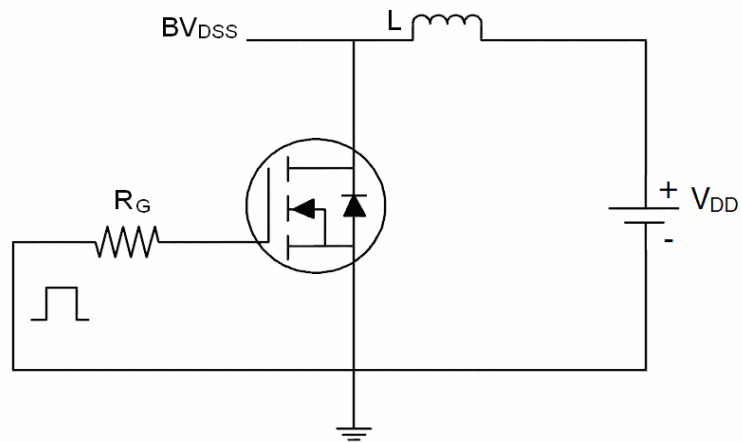

2) Gate Charge Test Circuit

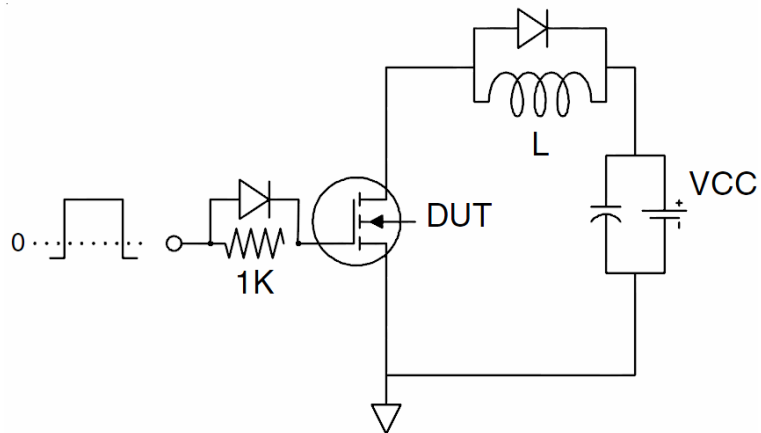

3) Switch Time Test Circuit



Typical Electrical and Thermal Characteristics (Curves)

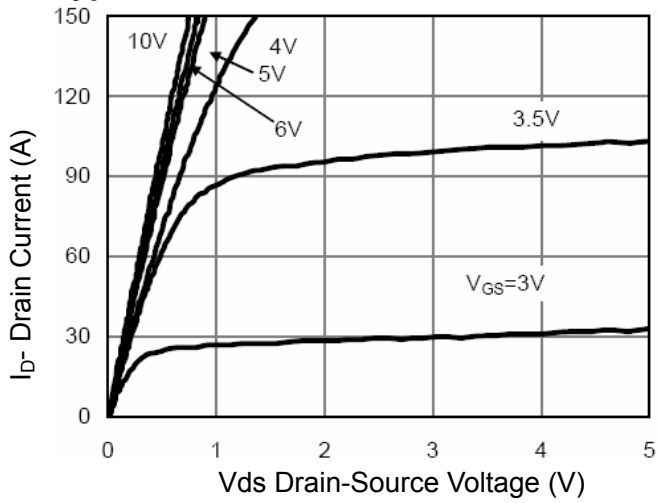

Figure 1 Output Characteristics

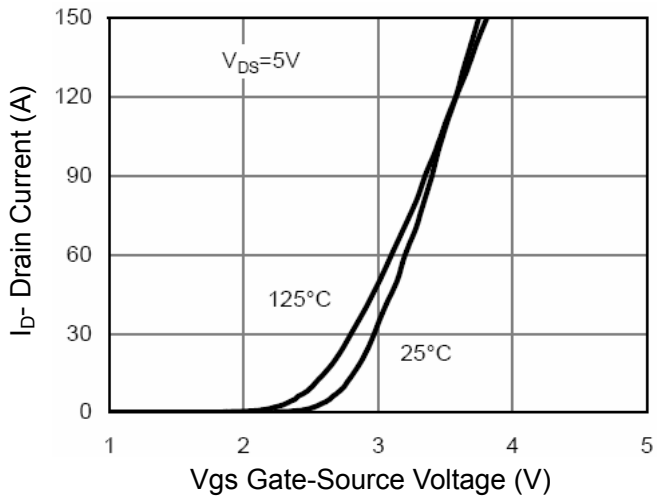

Figure 2 Transfer Characteristics

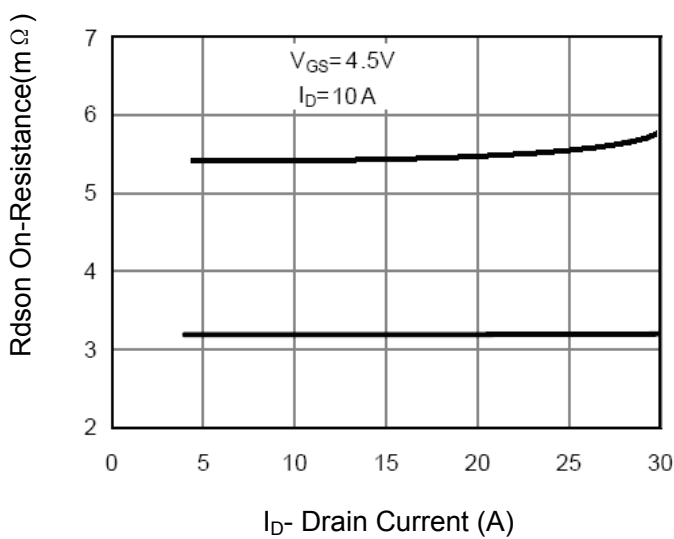

Figure 3 Rdson- Drain Current

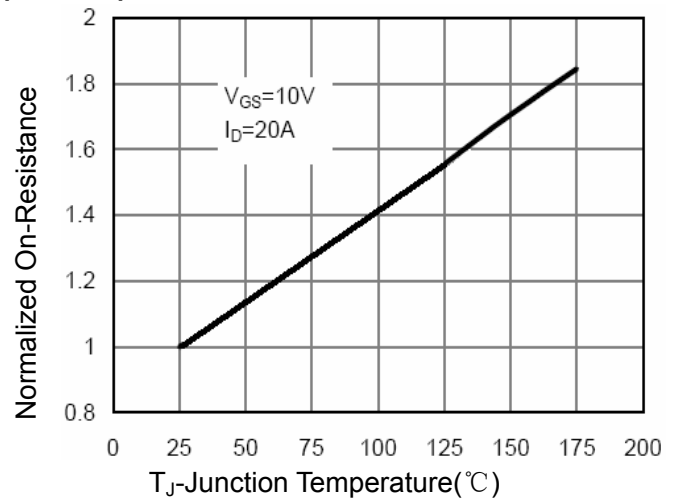

Figure 4 Rdson-Junction Temperature

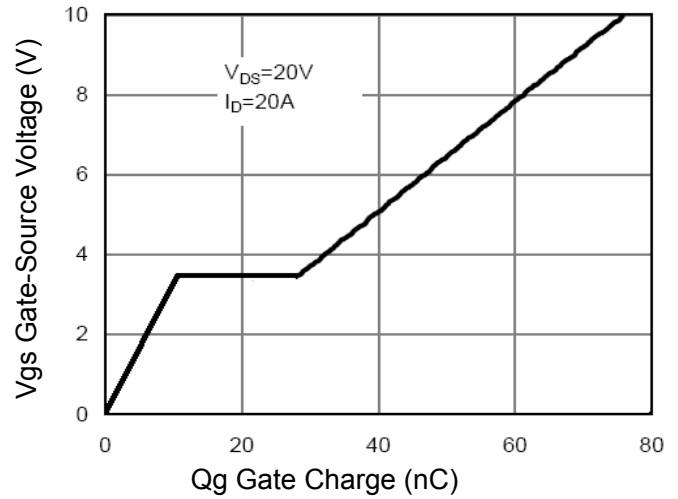

Figure 5 Gate Charge

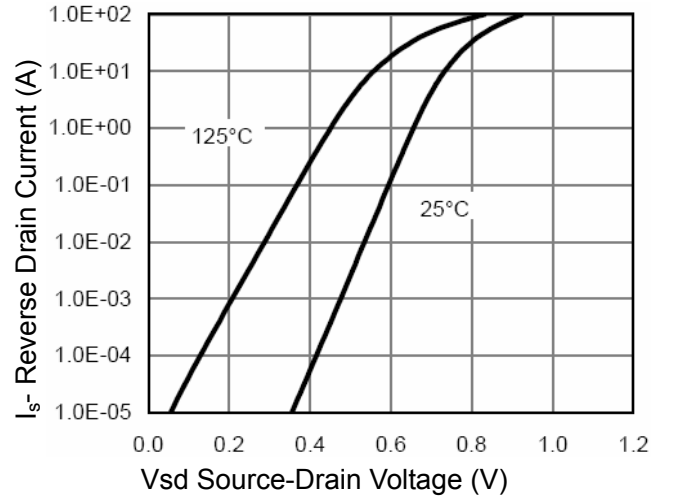

Figure 6 Source- Drain Diode Forward

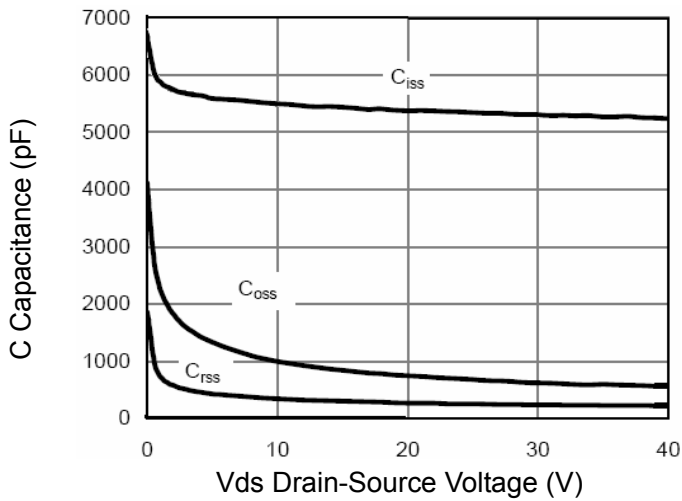

Figure 7 Capacitance vs Vds

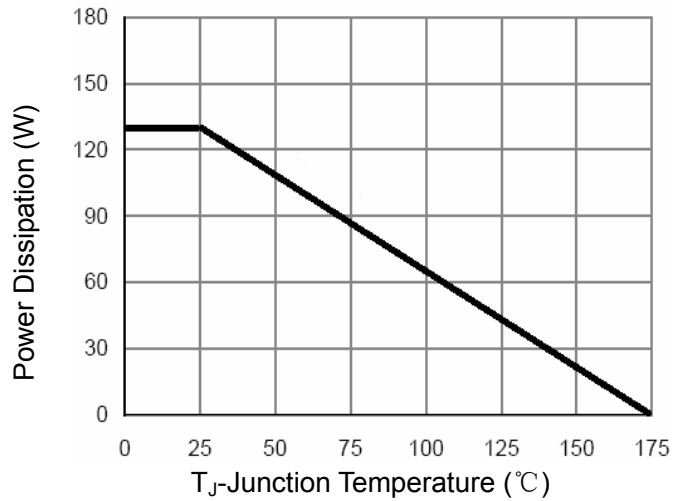

Figure 9 Power De-rating

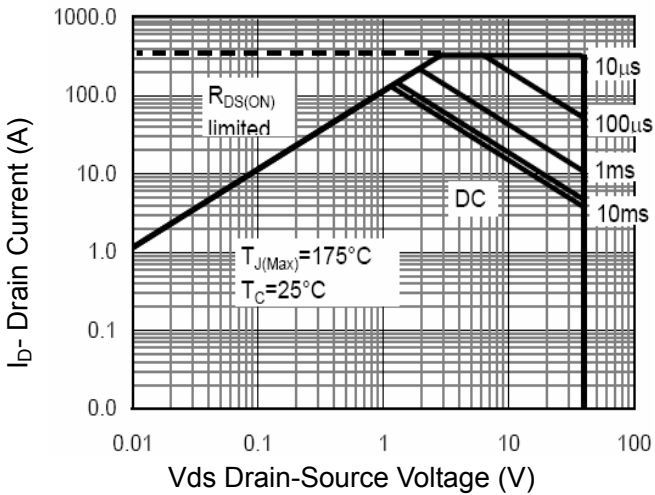

Figure 8 Safe Operation Area

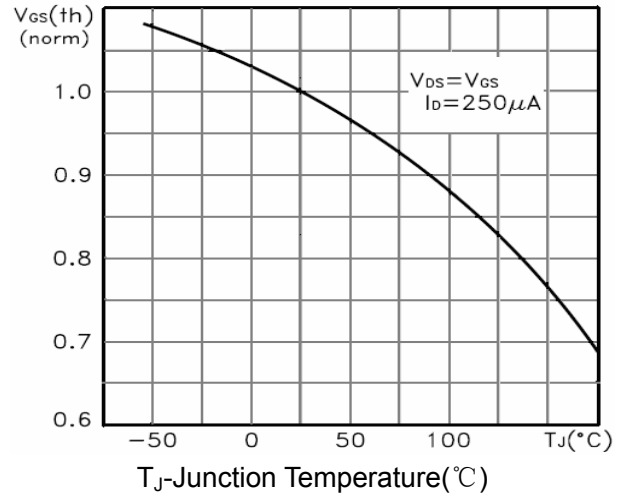

Figure 10 $V_{GS(th)}$ vs Junction Temperature

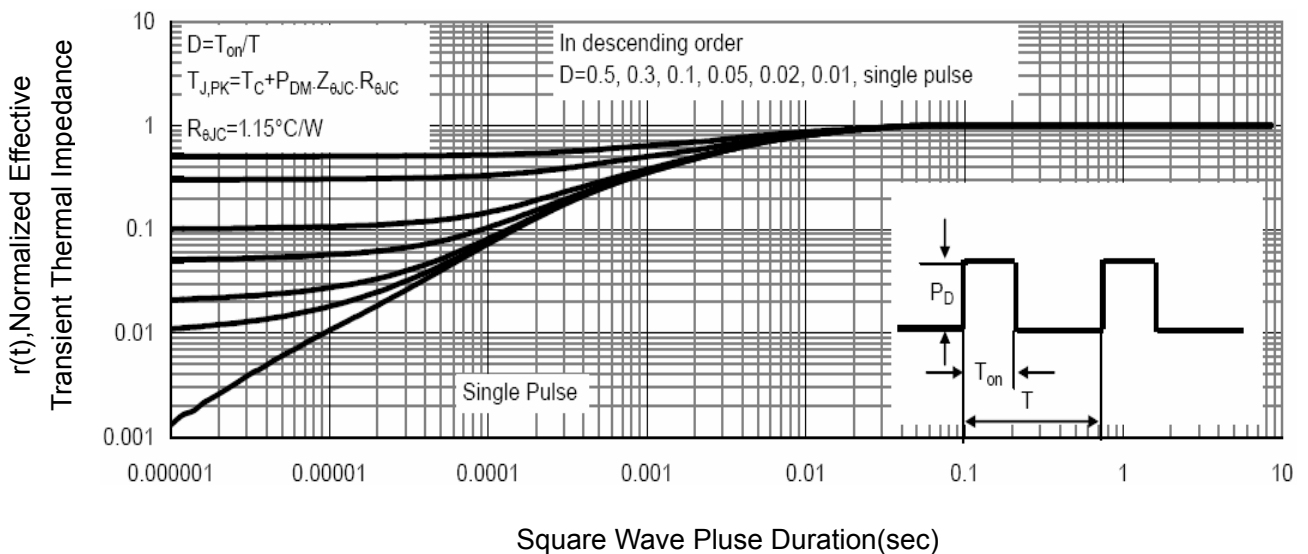

Figure 11 Normalized Maximum Transient Thermal Impedance

X-ON Electronics

Largest Supplier of Electrical and Electronic Components

Click to view similar products for [MOSFET](#) category:

Click to view products by [GOFORD](#) manufacturer:

Other Similar products are found below :

[614233C](#) [648584F](#) [FDPF9N50NZ](#) [IRFD120](#) [IRFF430](#) [JANTX2N5237](#) [2N7000](#) [FCA20N60_F109](#) [FDZ595PZ](#) [2SK2267\(Q\)](#) [2SK2545\(Q,T\)](#)
[405094E](#) [423220D](#) [MIC4420CM-TR](#) [VN1206L](#) [614234A](#) [715780A](#) [SSM6J414TU,LF\(T](#) [751625C](#) [PSMN4R2-30MLD](#)
[TK31J60W5,S1VQ\(O](#) [2SK2614\(TE16L1,Q\)](#) [DMN1017UCP3-7](#) [EFC2J004NUZTDG](#) [FCAB21350L1](#) [P85W28HP2F-7071](#) [DMN1053UCP4-7](#)
[NTE2384](#) [NTE2969](#) [NTE6400A](#) [DMN61D9UWQ-13](#) [US6M2GTR](#) [DMN31D5UDJ-7](#) [SSM6P54TU,LF](#) [DMP22D4UFO-7B](#)
[IPS60R3K4CEAKMA1](#) [DMN1006UCA6-7](#) [DMN16M9UCA6-7](#) [STF5N65M6](#) [STU5N65M6](#) [C3M0021120D](#) [DMN13M9UCA6-7](#)
[BSS340NWH6327XTSA1](#) [MCM3400A-TP](#) [DMTH10H4M6SPS-13](#) [IPS60R1K0PFD7SAKMA1](#) [IPS60R360PFD7SAKMA1](#)
[IPS60R600PFD7SAKMA1](#) [IPS60R210PFD7SAKMA1](#) [DMN2990UFB-7B](#)