

## N-Channel Enhancement Mode Power MOSFET

### Description

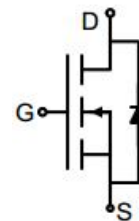
The G28N03D3 uses advanced trench technology to provide excellent  $R_{DS(ON)}$ , low gate charge. It can be used in a wide variety of applications.

### General Features

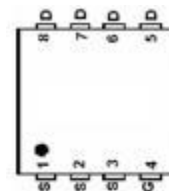
- $V_{DS}$  30V
- $I_D$  (at  $V_{GS} = 10V$ ) 28A
- $R_{DS(ON)}$  (at  $V_{GS} = 10V$ ) < 12m $\Omega$
- $R_{DS(ON)}$  (at  $V_{GS} = 4.5V$ ) < 18m $\Omega$
- 100% Avalanche Tested
- RoHS Compliant

### Application

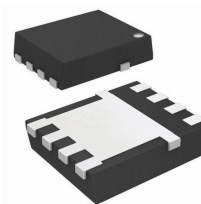
- Power switch
- DC/DC converters



Schematic diagram



pin assignment



DFN3X3-8L

### Ordering Information

Device	Package	Marking	Packaging
G28N03D3	DFN3X3-8L	G28N03	5000psc/Reel

### Absolute Maximum Ratings $T_C = 25^\circ\text{C}$ , unless otherwise noted

Parameter	Symbol	Value	Unit
Drain-Source Voltage	$V_{DS}$	30	V
Continuous Drain Current	$I_D$	28	A
Pulsed Drain Current (note1)	$I_{DM}$	112	A
Gate-Source Voltage	$V_{GS}$	$\pm 20$	V
Power Dissipation	$P_D$	23	W
Operating Junction and Storage Temperature Range	$T_J, T_{stg}$	-55 To 150	$^\circ\text{C}$

### Thermal Resistance

Parameter	Symbol	Value	Unit
Thermal Resistance, Junction-to-Ambient	$R_{thJA}$	65	$^\circ\text{C/W}$
Maximum Junction-to-Case	$R_{thJC}$	5.4	$^\circ\text{C/W}$

Specifications $T_J = 25^\circ\text{C}$ , unless otherwise noted						
Parameter	Symbol	Test Conditions	Value			Unit
			Min.	Typ.	Max.	
<b>Static Parameters</b>						
Drain-Source Breakdown Voltage	$V_{(BR)DSS}$	$V_{GS} = 0V, I_D = 250\mu A$	30	--	--	V
Zero Gate Voltage Drain Current	$I_{DSS}$	$V_{DS} = 30V, V_{GS} = 0V$	--	--	1	$\mu A$
Gate-Source Leakage	$I_{GSS}$	$V_{GS} = \pm 20V$	--	--	$\pm 100$	nA
Gate-Source Threshold Voltage	$V_{GS(th)}$	$V_{DS} = V_{GS}, I_D = 250\mu A$	1	2	2.5	V
Drain-Source On-Resistance	$R_{DS(on)}$	$V_{GS} = 10V, I_D = 16A$	--	6.5	12	m $\Omega$
		$V_{GS} = 4.5V, I_D = 14A$	--	15	18	
Forward Transconductance	$g_{FS}$	$V_{GS} = 5V, I_D = 10A$	--	2.5	--	S
<b>Dynamic Parameters</b>						
Input Capacitance	$C_{iss}$	$V_{GS} = 0V,$ $V_{DS} = 15V,$ $f = 1.0MHz$	--	896	--	pF
Output Capacitance	$C_{oss}$		--	145	--	
Reverse Transfer Capacitance	$C_{rss}$		--	129	--	
Total Gate Charge	$Q_g$	$V_{DD} = 15V,$ $I_D = 16A,$ $V_{GS} = 10V$	--	20	--	nC
Gate-Source Charge	$Q_{gs}$		--	2.5	--	
Gate-Drain Charge	$Q_{gd}$		--	4.9	--	
Turn-on Delay Time	$t_{d(on)}$	$V_{DD} = 15V,$ $I_D = 16A,$ $R_G = 3\Omega$	--	28	--	ns
Turn-on Rise Time	$t_r$		--	15	--	
Turn-off Delay Time	$t_{d(off)}$		--	28	--	
Turn-off Fall Time	$t_f$		--	14	--	
<b>Drain-Source Body Diode Characteristics</b>						
Continuous Body Diode Current	$I_S$	$T_C = 25^\circ\text{C}$	--	--	28	A
Body Diode Voltage	$V_{SD}$	$T_J = 25^\circ\text{C}, I_{SD} = 16A, V_{GS} = 0V$	--	--	1.2	V
Reverse Recovery Charge	$Q_{rr}$	$I_F = 16A, V_{GS} = 0V$ $di/dt=100A/us$	--	10.5	--	nC
Reverse Recovery Time	$T_{rr}$		--	25	--	ns

### Notes

1. Repetitive Rating: Pulse width limited by maximum junction temperature
2. EAS condition :  $T_J=25^\circ\text{C}$  , $V_{DD}= 30V, V_{GS}=10V, L=0.5mH, R_G=25\Omega$
3. Identical low side and high side switch with identical  $R_G$

### Gate Charge Test Circuit



### Switch Time Test Circuit

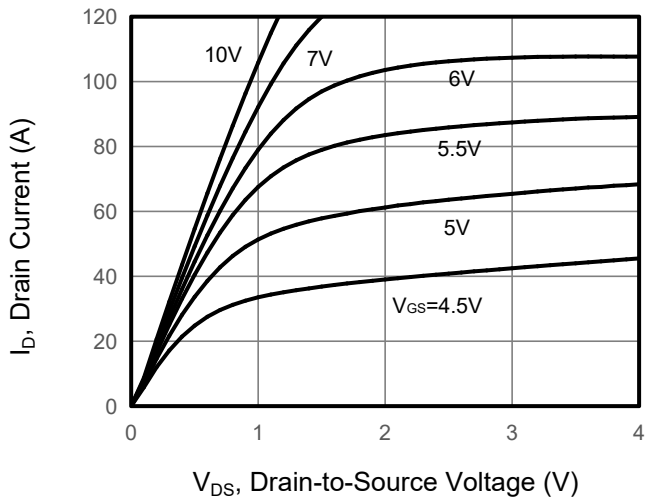


### EAS Test Circuit

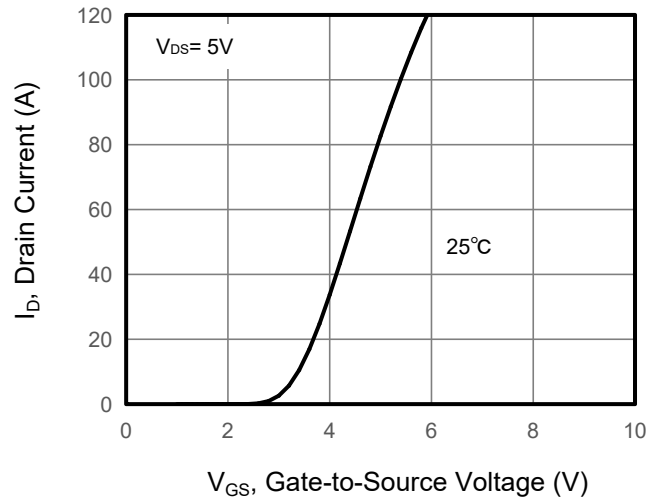


Typical Characteristics  $T_J = 25^\circ\text{C}$ , unless otherwise noted

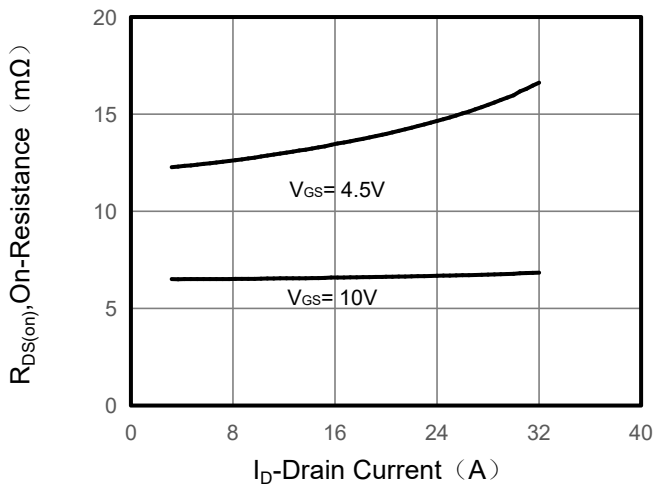
**Figure 1. Output Characteristics**



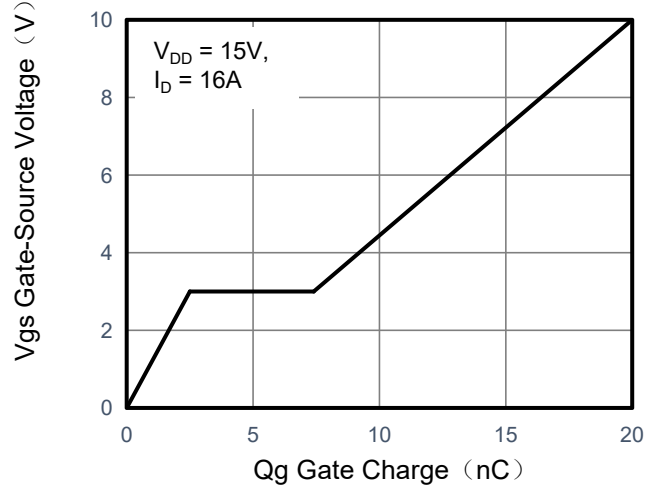
**Figure 2. Transfer Characteristics**



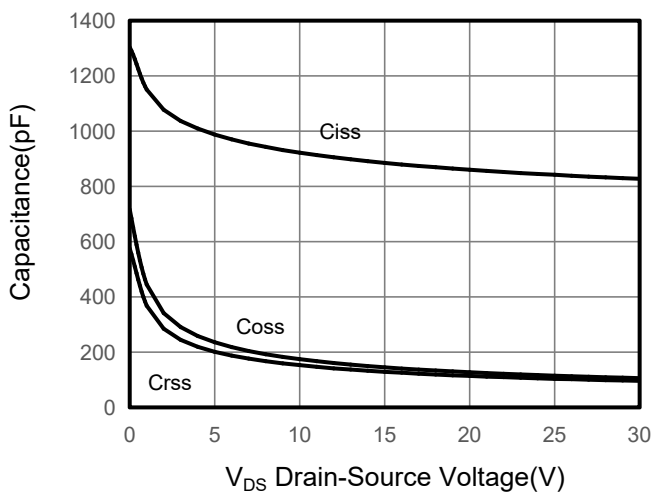
**Figure 3. Drain Source On Resistance**



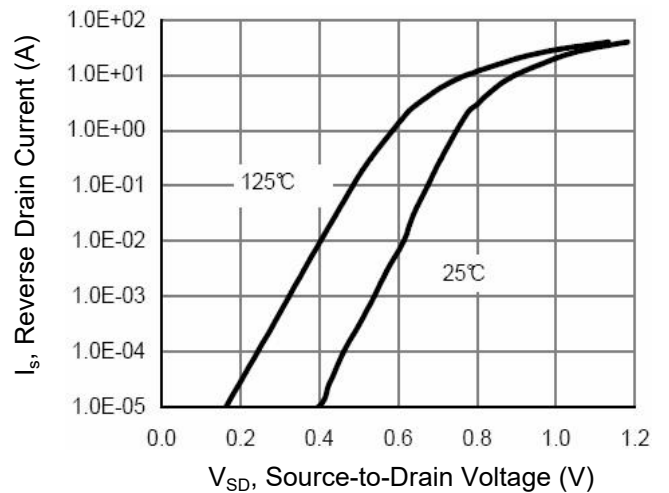
**Figure 4. Gate Charge**



**Figure 5. Capacitance**

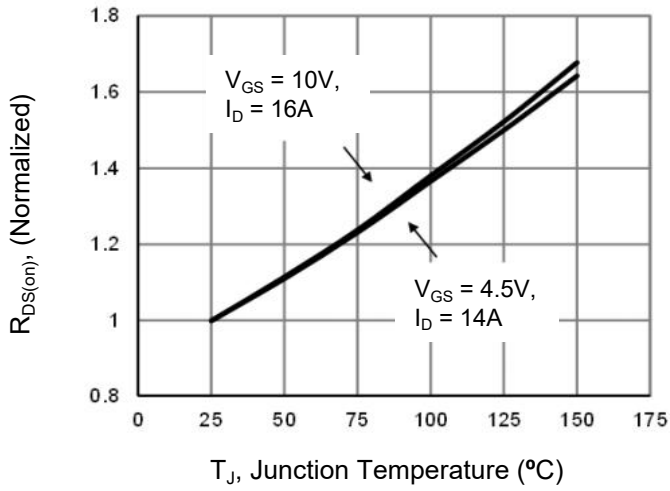


**Figure 6. Source-Drain Diode Forward**

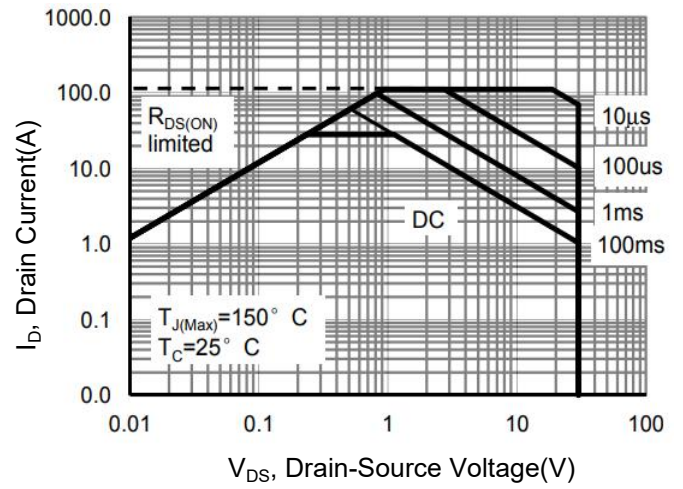


## Typical Characteristics $T_J = 25^\circ\text{C}$ , unless otherwise noted

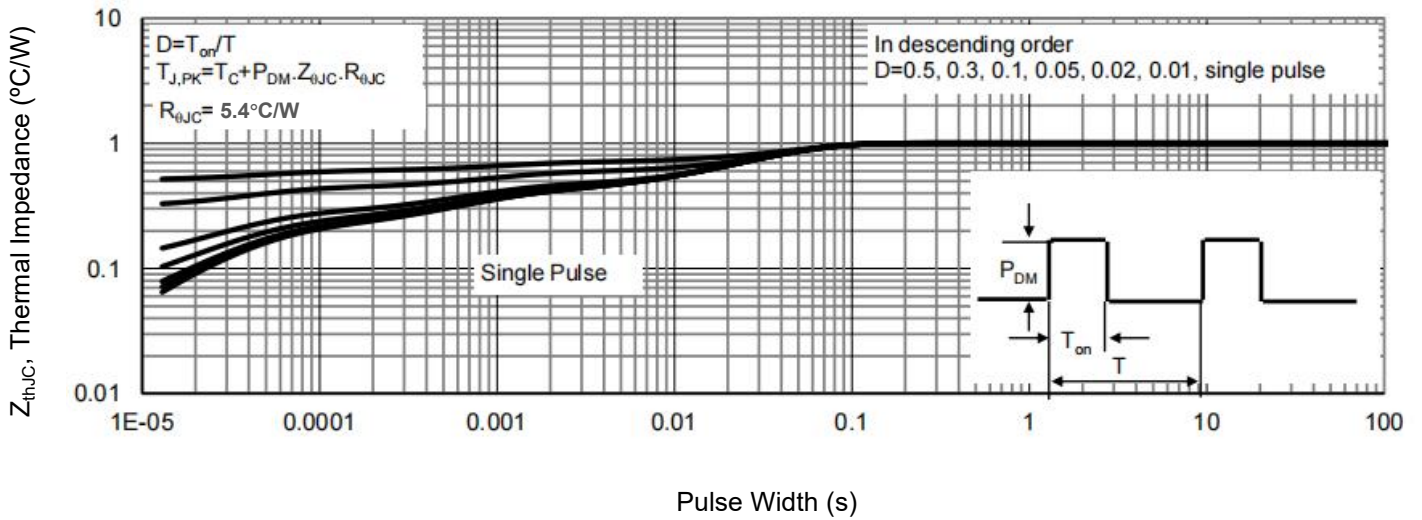
**Figure 7. Drain-Source On-Resistance**



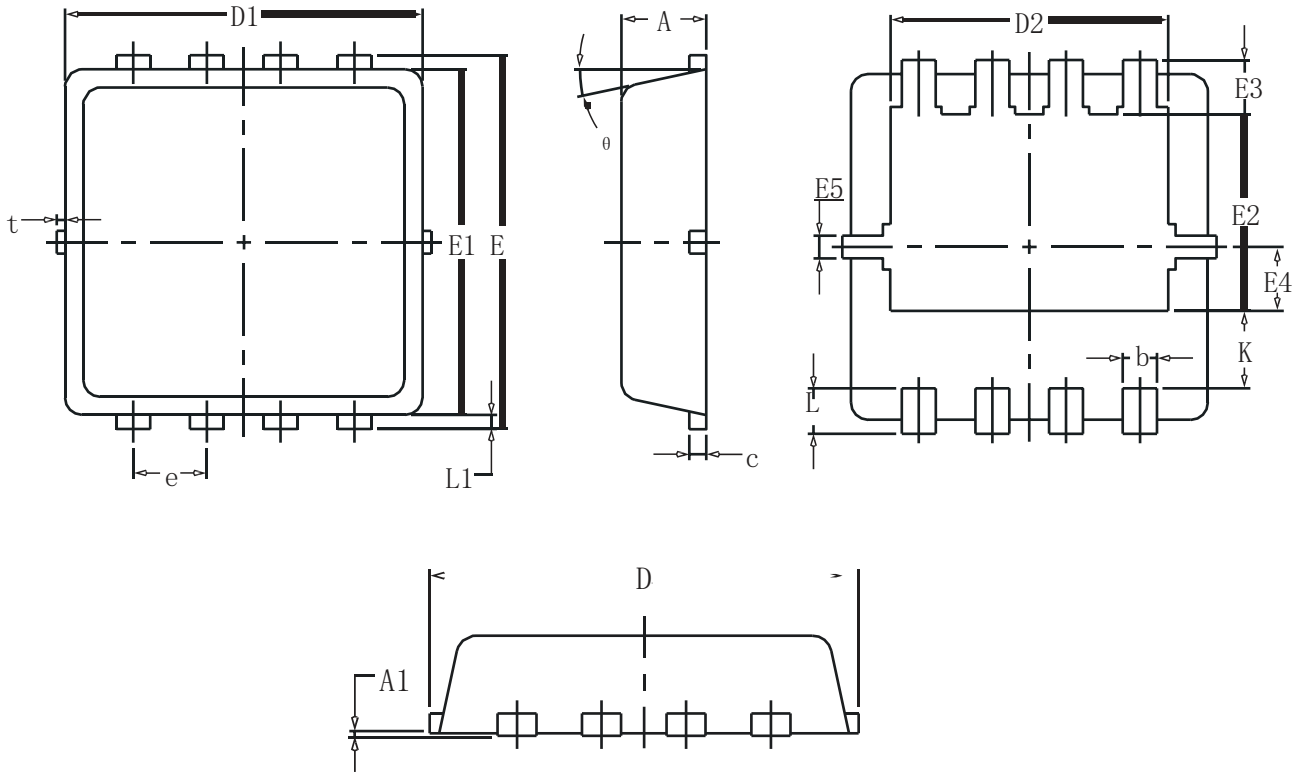
**Figure 8. Safe Operation Area**



**Figure 9. Normalized Maximum Transient Thermal Impedance**



## DFN3x3-8L Package Information



SYMBOL	COMMON		
	MM		
	MIN	NOM	MAX
A	0.70	0.75	0.85
A1	-	-	0.05
b	0.20	0.30	0.40
c	0.10	0.152	0.25
D	3.15	3.30	3.45
D1	3.00	3.15	3.25
D2	2.29	2.45	2.65
E	3.15	3.30	3.45
E1	2.90	3.05	3.20
E2	1.54	1.74	1.94
E3	0.28	0.48	0.65
E4	0.37	0.57	0.77
E5	0.10	0.20	0.30
e	0.60	0.65	0.70
K	0.59	0.69	0.89
L	0.30	0.40	0.50
L1	0.06	0.125	0.20
t	0	0.075	0.13
θ	10°	12°	14°

## X-ON Electronics

Largest Supplier of Electrical and Electronic Components

*Click to view similar products for [MOSFET](#) category:*

*Click to view products by [GOFORD](#) manufacturer:*

Other Similar products are found below :

[614233C](#) [648584F](#) [IRFD120](#) [IRFF430](#) [JANTX2N5237](#) [2N7000](#) [FCA20N60\\_F109](#) [FDZ595PZ](#) [AOD464](#) [2SK2267\(Q\)](#) [2SK2545\(Q,T\)](#)  
[405094E](#) [423220D](#) [MIC4420CM-TR](#) [VN1206L](#) [614234A](#) [715780A](#) [SSM6J414TU,LF\(T](#) [751625C](#) [PSMN4R2-30MLD](#)  
[TK31J60W5,S1VQ\(O](#) [2SK2614\(TE16L1,Q\)](#) [DMN1017UCP3-7](#) [EFC2J004NUZTDG](#) [FCAB21350L1](#) [P85W28HP2F-7071](#) [DMN1053UCP4-7](#)  
[NTE2384](#) [NTE2969](#) [NTE6400A](#) [DMN2080UCB4-7](#) [DMN61D9UWQ-13](#) [US6M2GTR](#) [DMN31D5UDJ-7](#) [SSM6P54TU,LF](#) [DMP22D4UFO-](#)  
[7B](#) [IPS60R3K4CEAKMA1](#) [DMN1006UCA6-7](#) [DMN16M9UCA6-7](#) [STF5N65M6](#) [STU5N65M6](#) [C3M0021120D](#) [DMN13M9UCA6-7](#)  
[BSS340NWH6327XTSA1](#) [MCM3400A-TP](#) [DMTH10H4M6SPS-13](#) [IRF40SC240ARMA1](#) [IPS60R1K0PFD7SAKMA1](#)  
[IPS60R360PFD7SAKMA1](#) [IPS60R600PFD7SAKMA1](#)