

P-Channel Enhancement Mode Power MOSFET

Description

The G400P06S uses advanced trench technology to provide excellent $R_{DS(ON)}$, low gate charge. It can be used in a wide variety of applications.

General Features

- V_{DS} -60V
- I_D (at $V_{GS} = -10V$) -6A
- $R_{DS(ON)}$ (at $V_{GS} = -10V$) < 40m Ω
- 100% Avalanche Tested
- RoHS Compliant

Application

- Power switch
- DC/DC converters

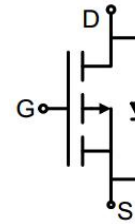

Schematic diagram

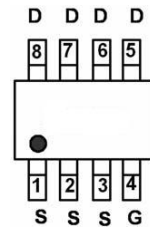

pin assignment



SOP-8

Ordering Information

| Device | Package | Marking | Packaging |
|----------|---------|---------|--------------|
| G400P06S | SOP-8 | G400P06 | 4000pcs/Reel |

Absolute Maximum Ratings $T_C = 25^\circ C$, unless otherwise noted

| Parameter | Symbol | Value | Unit |
|--|----------------|------------|------------|
| Drain-Source Voltage | V_{DS} | -60 | V |
| Continuous Drain Current | I_D | -6 | A |
| Pulsed Drain Current (note1) | I_{DM} | -24 | A |
| Gate-Source Voltage | V_{GS} | ± 20 | V |
| Power Dissipation | P_D | 1.7 | W |
| Single pulse avalanche energy (note2) | E_{AS} | 144 | mJ |
| Operating Junction and Storage Temperature Range | T_J, T_{stg} | -55 To 150 | $^\circ C$ |

Thermal Resistance

| Parameter | Symbol | Value | Unit |
|---|------------|-------|--------------|
| Thermal Resistance, Junction-to-Ambient | R_{thJA} | 75 | $^\circ C/W$ |

| Specifications $T_J = 25^\circ\text{C}$, unless otherwise noted | | | | | | |
|--|---------------|---|-------|------|-----------|------------|
| Parameter | Symbol | Test Conditions | Value | | | Unit |
| | | | Min. | Typ. | Max. | |
| Static Parameters | | | | | | |
| Drain-Source Breakdown Voltage | $V_{(BR)DSS}$ | $V_{GS} = 0V, I_D = -250\mu A$ | -60 | -- | -- | V |
| Zero Gate Voltage Drain Current | I_{DSS} | $V_{DS} = -60V, V_{GS} = 0V$ | -- | -- | -1 | μA |
| Gate-Source Leakage | I_{GSS} | $V_{GS} = \pm 20V$ | -- | -- | ± 100 | nA |
| Gate-Source Threshold Voltage | $V_{GS(th)}$ | $V_{DS} = V_{GS}, I_D = -250\mu A$ | -2 | -2.5 | -3 | V |
| Drain-Source On-Resistance | $R_{DS(on)}$ | $V_{GS} = -10V, I_D = -12A$ | -- | 33 | 40 | m Ω |
| Forward Transconductance | g_{FS} | $V_{DS} = -5V, I_D = -12A$ | -- | 15 | -- | S |
| Dynamic Parameters | | | | | | |
| Input Capacitance | C_{iss} | $V_{GS} = 0V,$ $V_{DS} = -30V,$ $f = 1.0\text{MHz}$ | -- | 2506 | -- | pF |
| Output Capacitance | C_{oss} | | -- | 112 | -- | |
| Reverse Transfer Capacitance | C_{rss} | | -- | 110 | -- | |
| Total Gate Charge | Q_g | $V_{DD} = -30V,$ $I_D = -12A,$ $V_{GS} = -10V$ | -- | 46 | -- | nC |
| Gate-Source Charge | Q_{gs} | | -- | 10 | -- | |
| Gate-Drain Charge | Q_{gd} | | -- | 9 | -- | |
| Turn-on Delay Time | $t_{d(on)}$ | $V_{DD} = -30V,$ $I_D = -12A,$ $R_G = 3\Omega$ | -- | 10 | -- | ns |
| Turn-on Rise Time | t_r | | -- | 6 | -- | |
| Turn-off Delay Time | $t_{d(off)}$ | | -- | 44 | -- | |
| Turn-off Fall Time | t_f | | -- | 12 | -- | |
| Drain-Source Body Diode Characteristics | | | | | | |
| Continuous Body Diode Current | I_S | $T_C = 25^\circ\text{C}$ | -- | -- | -6 | A |
| Body Diode Voltage | V_{SD} | $T_J = 25^\circ\text{C}, I_{SD} = -12A, V_{GS} = 0V$ | -- | -- | -1.2 | V |
| Reverse Recovery Charge | Q_{rr} | $I_F = -12A, V_{GS} = 0V$ $di/dt = -100A/\mu s$ | -- | 47 | -- | nC |
| Reverse Recovery Time | T_{rr} | | -- | 34 | -- | ns |

Notes

1. Repetitive Rating: Pulse width limited by maximum junction temperature
2. EAS condition : $T_J = 25^\circ\text{C}, V_{DD} = -50V, V_{GS} = -10V, L = 0.5\text{mH}, R_G = 25\Omega$
3. Identical low side and high side switch with identical R_G

Gate Charge Test Circuit

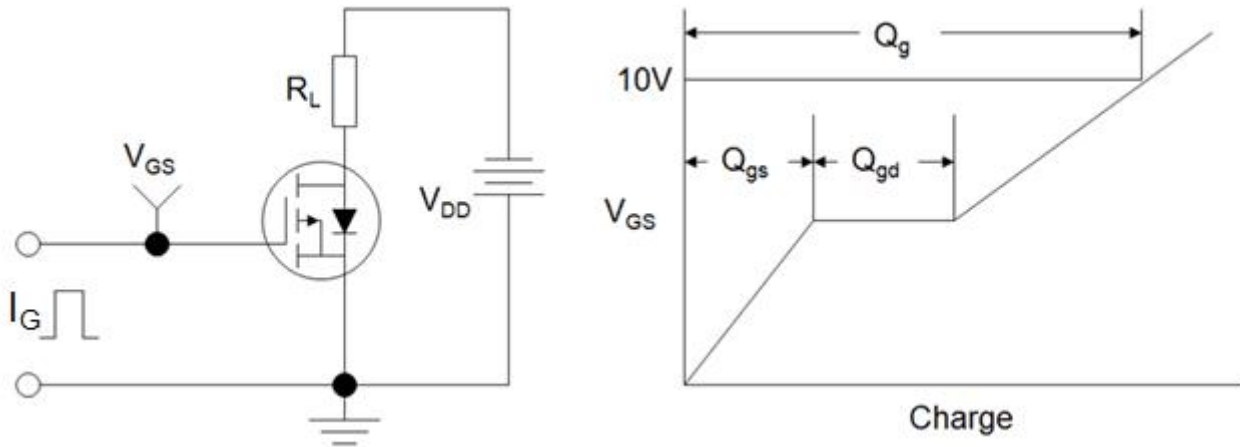

Switch Time Test Circuit

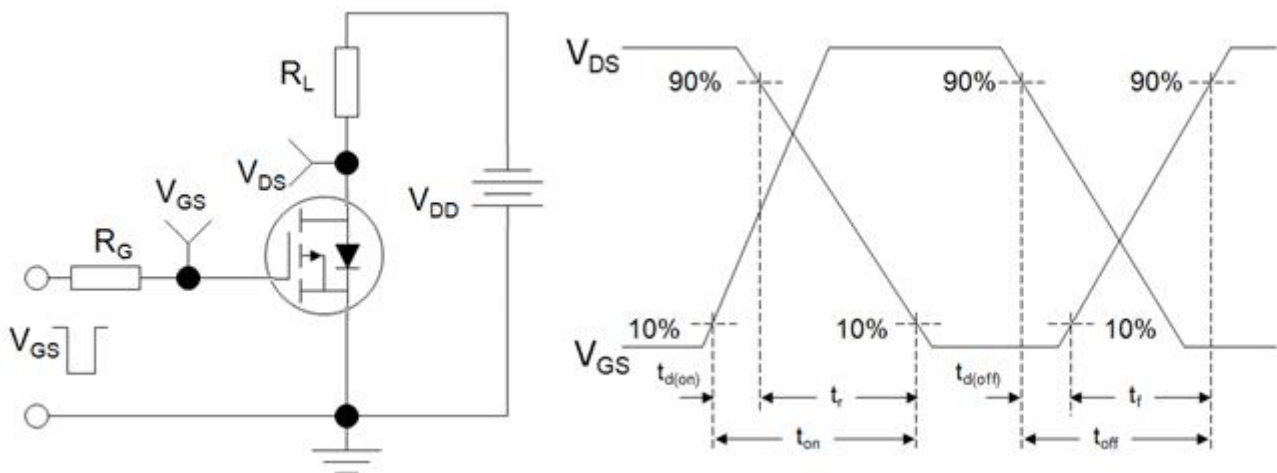

EAS Test Circuit

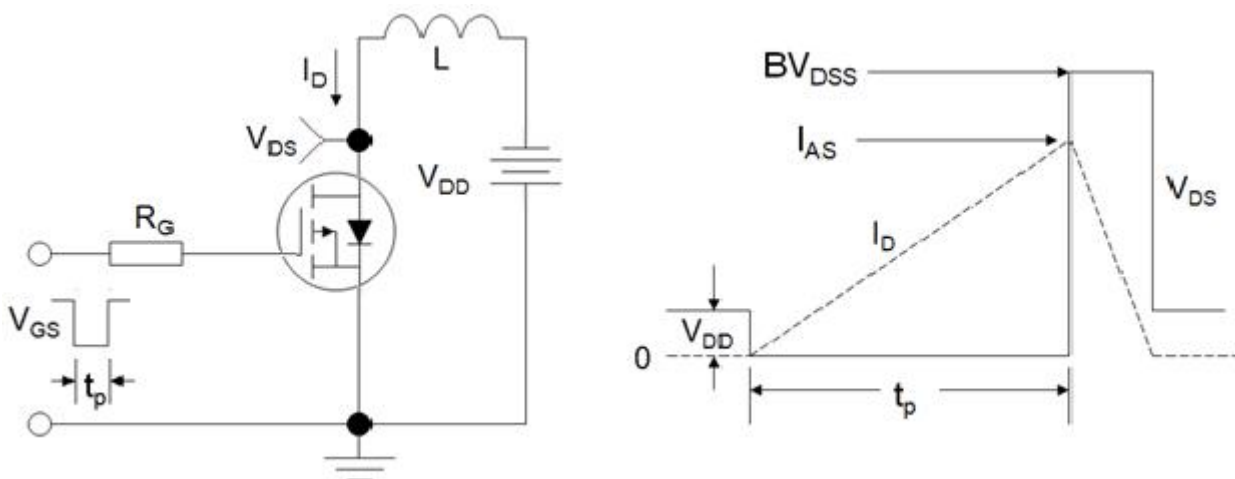

Typical Characteristics $T_J = 25^\circ\text{C}$, unless otherwise noted

Figure 1. Output Characteristics

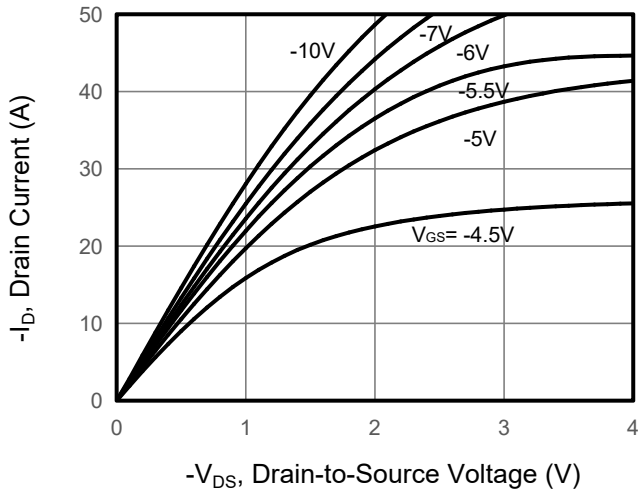

Figure 2. Transfer Characteristics

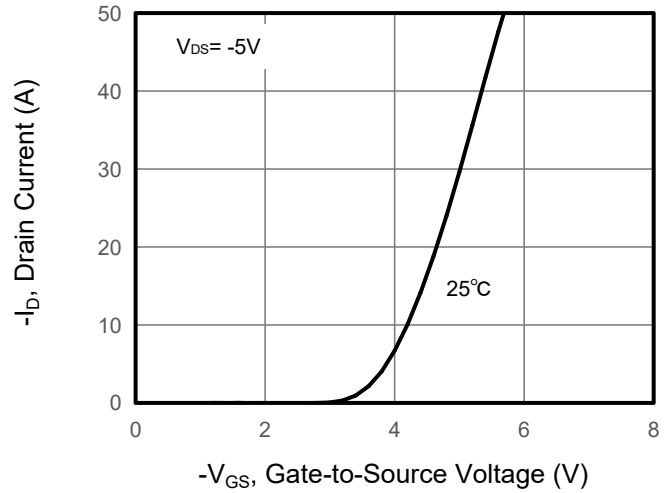

Figure 3. Drain Source On Resistance

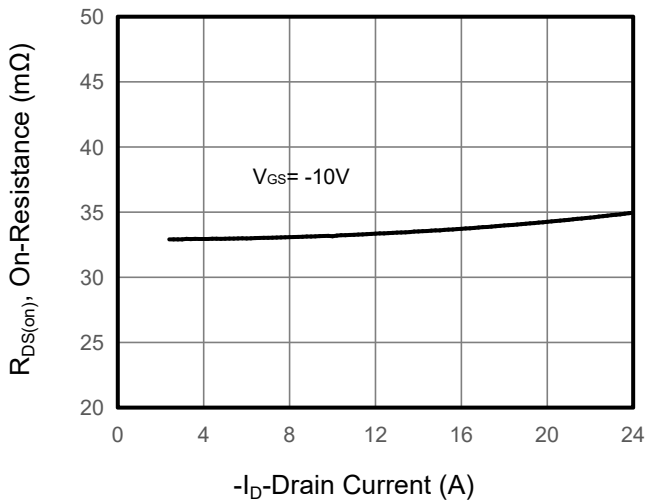

Figure 4. Gate Charge

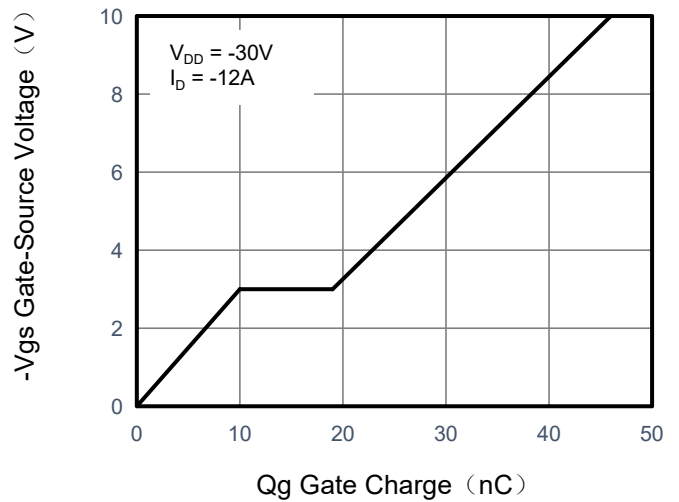

Figure 5. Capacitance

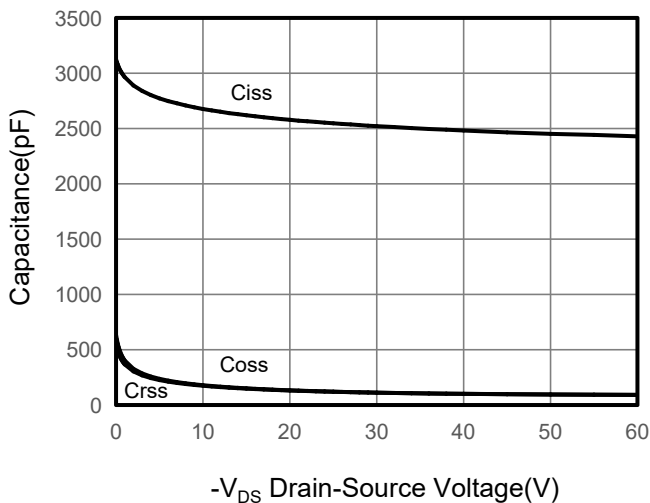
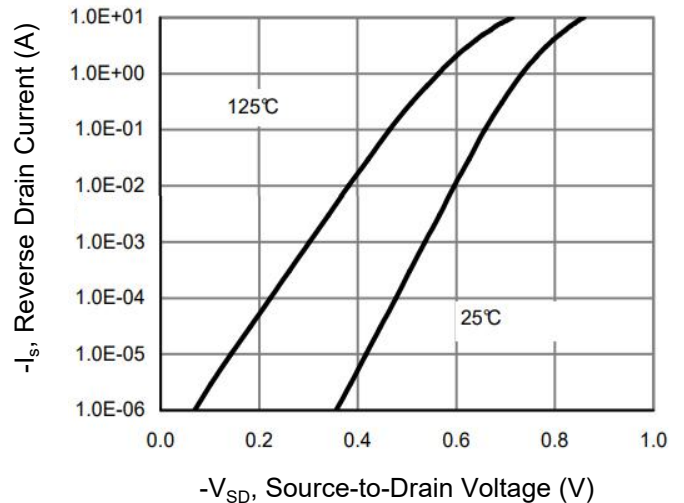

Figure 6. Source-Drain Diode Forward



Typical Characteristics $T_J = 25^\circ\text{C}$, unless otherwise noted

Figure 7. Drain-Source On-Resistance

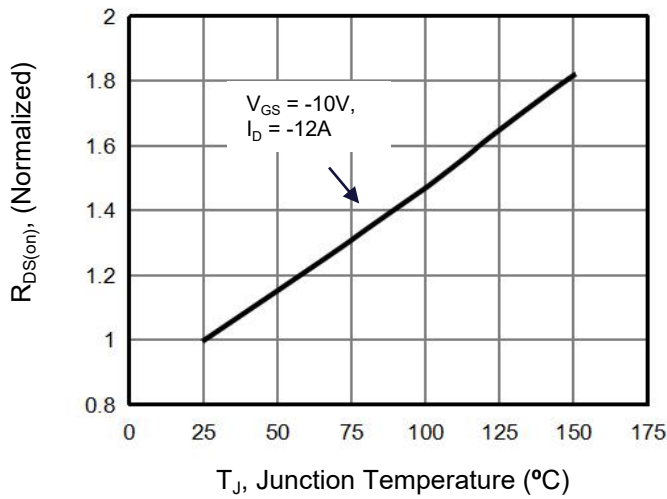

Figure 10. Safe Operation Area

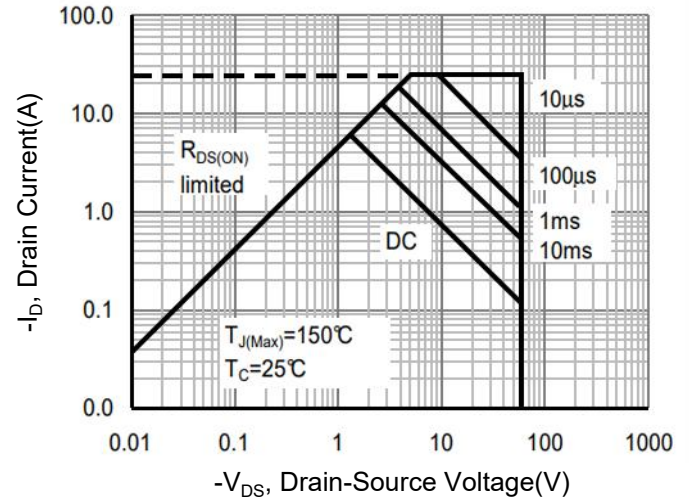
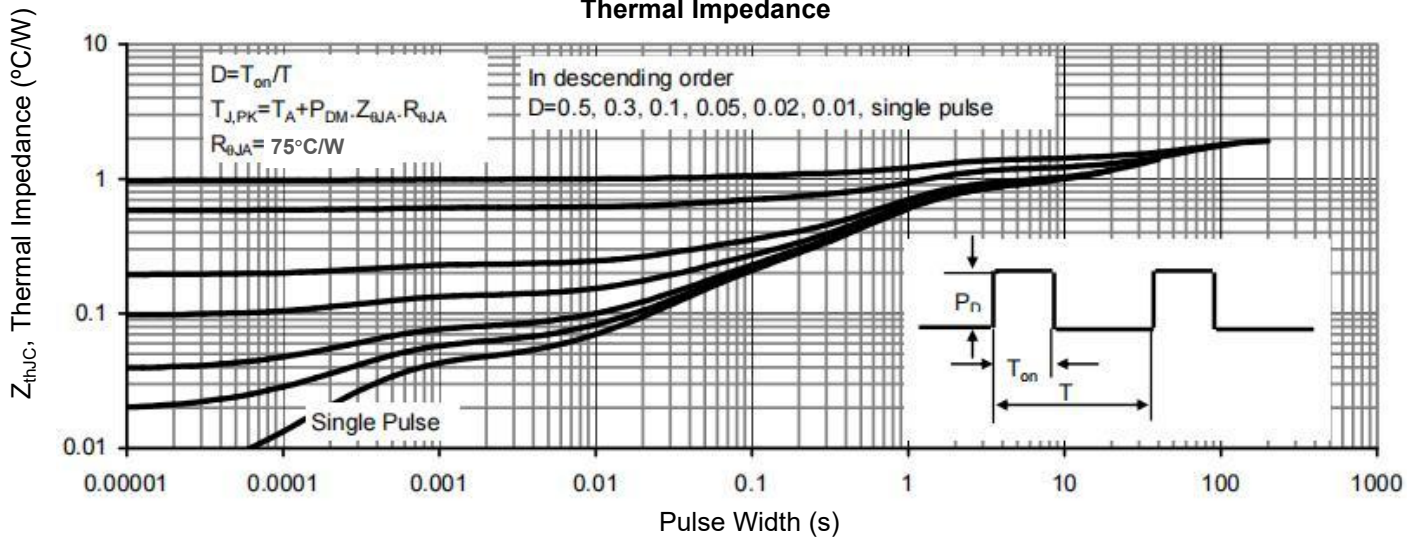
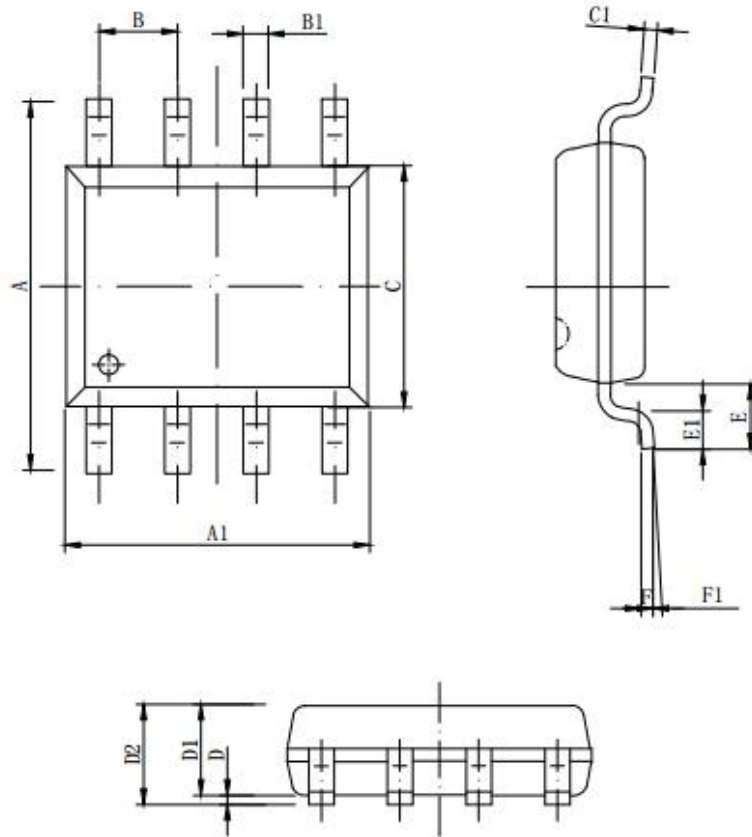

Figure 9. Normalized Maximum Transient Thermal Impedance



SOP-8 Package Information



| Symbol | Dimensions in Millimeters | | |
|--------|---------------------------|--------------------|--------------------|
| | MIN. | NOM. | MAX. |
| A | 5.800 | 6.000 | 6.200 |
| A1 | 4.800 | 4.900 | 5.000 |
| B | 1.270BSC | | |
| B1 | 0.35 ^{8x} | 0.40 ^{8x} | 0.45 ^{8x} |
| C | 3.780 | 3.880 | 3.980 |
| C1 | -- | 0.203 | 0.253 |
| D | 0.050 | 0.150 | 0.250 |
| D1 | 1.350 | 1.450 | 1.550 |
| D2 | 1.500 | 1.600 | 1.700 |
| D2 | 1.500 | 1.600 | 1.700 |
| E | 1.060REF | | |
| E1 | 0.400 | 0.700 | 0.100 |
| F | 0.250BSC | | |
| F1 | 2° | 4° | 6° |

X-ON Electronics

Largest Supplier of Electrical and Electronic Components

Click to view similar products for [MOSFET](#) category:

Click to view products by [GOFORD](#) manufacturer:

Other Similar products are found below :

[IRFD120](#) [JANTX2N5237](#) [BUK455-60A/B](#) [MIC4420CM-TR](#) [VN1206L](#) [NDP4060](#) [SI4482DY](#) [IPS70R2K0CEAKMA1](#) [SQD23N06-31L-GE3](#)
[TK16J60W,S1VQ\(O](#) [2SK2614\(TE16L1,Q\)](#) [DMN1017UCP3-7](#) [DMN1053UCP4-7](#) [SQJ469EP-T1-GE3](#) [NTE2384](#) [DMC2700UDMQ-7](#)
[DMN2080UCB4-7](#) [DMN61D9UWQ-13](#) [US6M2GTR](#) [DMN31D5UDJ-7](#) [DMP22D4UFO-7B](#) [DMN1006UCA6-7](#) [DMN16M9UCA6-7](#)
[STF5N65M6](#) [IRF40H233XTMA1](#) [STU5N65M6](#) [DMN6022SSD-13](#) [DMN13M9UCA6-7](#) [DMTH10H4M6SPS-13](#) [DMN2990UFB-7B](#)
[IPB80P04P405ATMA2](#) [2N7002W-G](#) [MCAC30N06Y-TP](#) [MCQ7328-TP](#) [NTMC083NP10M5L](#) [BXP7N65D](#) [BXP4N65F](#) [AOL1454G](#)
[WMJ80N60C4](#) [BXP2N20L](#) [BXP2N65D](#) [BXT1150N10J](#) [BXT1700P06M](#) [TSM60NB380CP](#) [ROG](#) [RQ7L055BGTGR](#) [DMNH15H110SK3-13](#)
[SLF10N65ABV2](#) [BSO203SP](#) [BSO211P](#) [IPA60R230P6](#)