

Description

The G66 uses advanced trench technology to provide excellent $R_{DS(ON)}$, low gate charge and operation with gate voltages as low as 2.5V. This device is suitable for use as a load switch or in PWM applications.

General Features

-

V_{DSS}	$R_{DS(ON)}$ @-4.5V(Typ)	$R_{DS(ON)}$ @-2.5V(Typ)	I_D
-16V	33 m Ω	45m Ω	-5.8A

- High Power and current handing capability
- Lead free product is acquired
- Surface Mount Package

Application

- PWM applications
- Load switch
- Power management

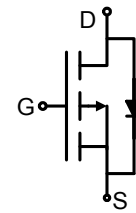

Schematic diagram

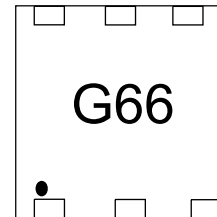

Marking and pin Assignment

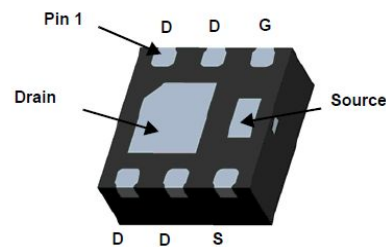

DFN2*2-6L

Absolute Maximum Ratings (TA=25°C unless otherwise noted)

Parameter	Symbol	Limit	Unit
Drain-Source Voltage	V_{DS}	-16	V
Gate-Source Voltage	V_{GS}	±8	V
Drain Current -Continuous	I_D	-5.8	A
Drain Current -Pulsed ^(Note 1)	I_{DM}	-15	A
Maximum Power Dissipation	P_D	1.7	W
Operating Junction and Storage Temperature Range	T_J, T_{STG}	-55 To 150	°C

Thermal Characteristic

Thermal Resistance, Junction-to-Ambient ^(Note 2)	$R_{\theta JA}$	74	°C/W
---	-----------------	----	------

Electrical Characteristics (TA=25°C unless otherwise noted)

Parameter	Symbol	Condition	Min	Typ	Max	Unit
Off Characteristics						

Drain-Source Breakdown Voltage	BV_{DSS}	$V_{GS}=0V, I_D=-250\mu A$	-	-16	-	V
Zero Gate Voltage Drain Current	I_{DSS}	$V_{DS}=-12V, V_{GS}=0V$	-	-	-1	μA
Gate-Body Leakage Current	I_{GSS}	$V_{GS}=\pm 8V, V_{DS}=0V$	-	-	± 100	nA
On Characteristics (Note 3)						
Gate Threshold Voltage	$V_{GS(th)}$	$V_{DS}=V_{GS}, I_D=-250\mu A$	-0.45	-0.7	-1.0	V
Drain-Source On-State Resistance	$R_{DS(ON)}$	$V_{GS}=-4.5V, I_D=-4.1A$	-	33	45	m Ω
		$V_{GS}=-2.5V, I_D=-3A$	-	45	60	
Forward Transconductance	g_{FS}	$V_{DS}=-5V, I_D=-3.5A$	-	8.5	-	S
Dynamic Characteristics (Note 4)						
Input Capacitance	C_{ISS}	$V_{DS}=-4V, V_{GS}=0V,$ $F=1.0MHz$	-	740	-	PF
Output Capacitance	C_{OSS}		-	290	-	PF
Reverse Transfer Capacitance	C_{RSS}		-	190	-	PF
Switching Characteristics (Note 4)						
Turn-on Delay Time	$t_{d(on)}$	$V_{DD}=-4V, I_D=-3.3A,$ $R_L=-1.2\Omega, V_{GEN}=-4.5V, R_g=1\Omega$	-	12	-	nS
Turn-on Rise Time	t_r		-	35	-	nS
Turn-Off Delay Time	$t_{d(off)}$		-	30	-	nS
Turn-Off Fall Time	t_f		-	10	-	nS
Total Gate Charge	Q_g	$V_{DS}=-4V, I_D=-4.1A, V_{GS}=-4.5V$	-	7.8	-	nC
Gate-Source Charge	Q_{gs}		-	1.2	-	nC
Gate-Drain Charge	Q_{gd}		-	1.6	-	nC
Drain-Source Diode Characteristics						
Diode Forward Voltage (Note 3)	V_{SD}	$V_{GS}=0V, I_S=-1.6A$	-	-	-1.2	V
Diode Forward Current (Note 2)	I_S		-	-	1.6	A

Notes:

1. Repetitive Rating: Pulse width limited by maximum junction temperature.
2. Surface Mounted on FR4 Board, $t \leq 10$ sec.
3. Pulse Test: Pulse Width $\leq 300\mu s$, Duty Cycle $\leq 2\%$.
4. Guaranteed by design, not subject to production

Typical Electrical and Thermal Characteristics



Figure 1: Switching Test Circuit

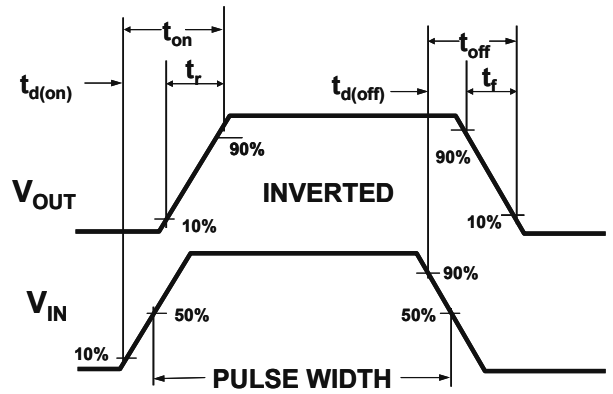

Figure 2: Switching Waveforms

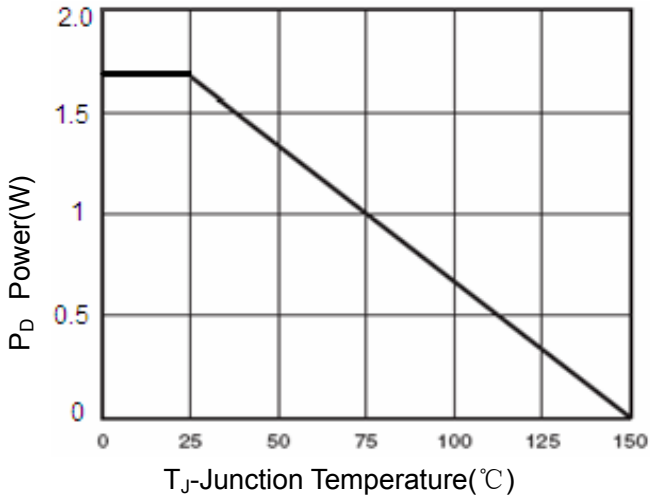

Figure 3 Power Dissipation

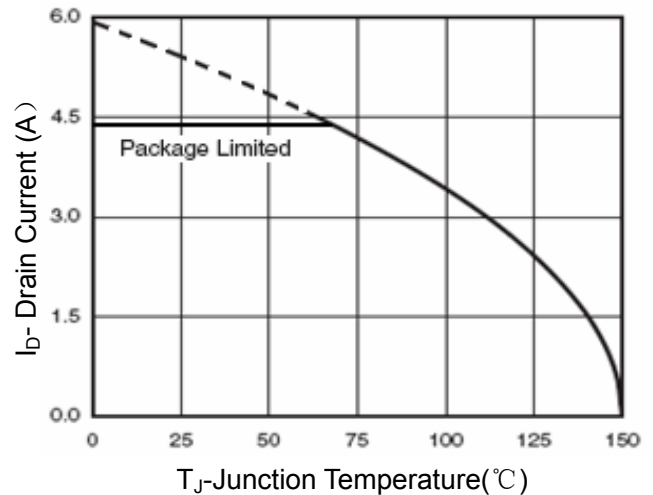

Figure 4 Drain Current

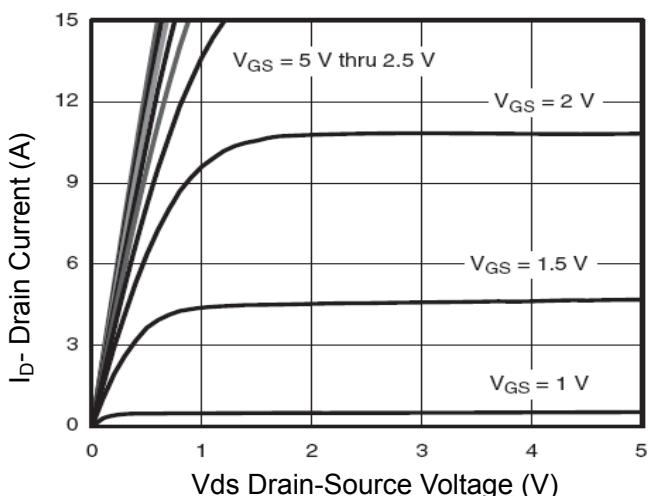

Figure 5 Output Characteristics

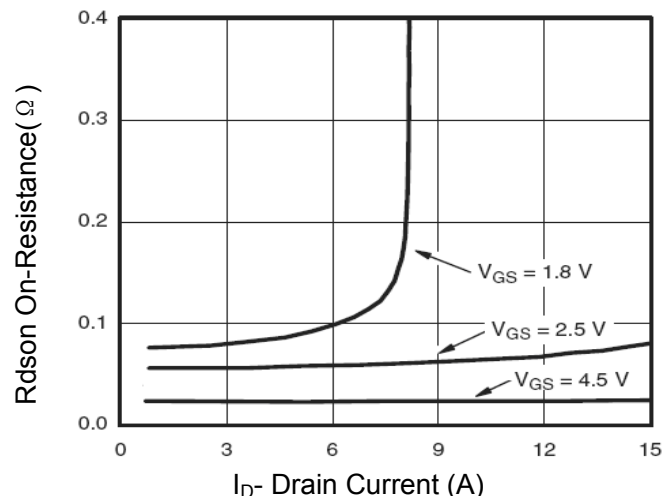
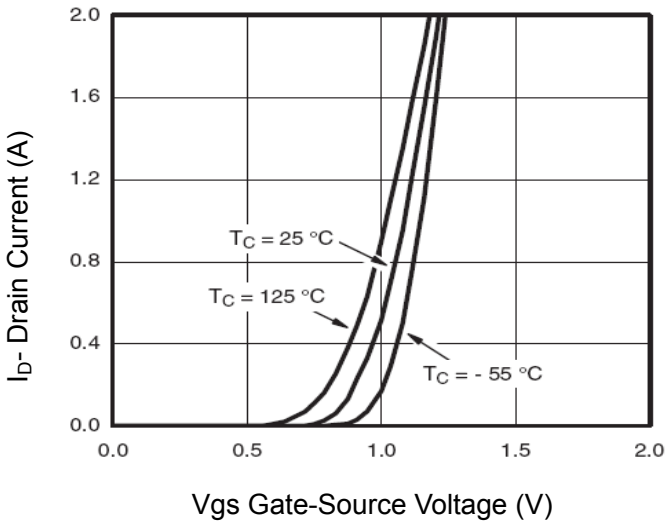
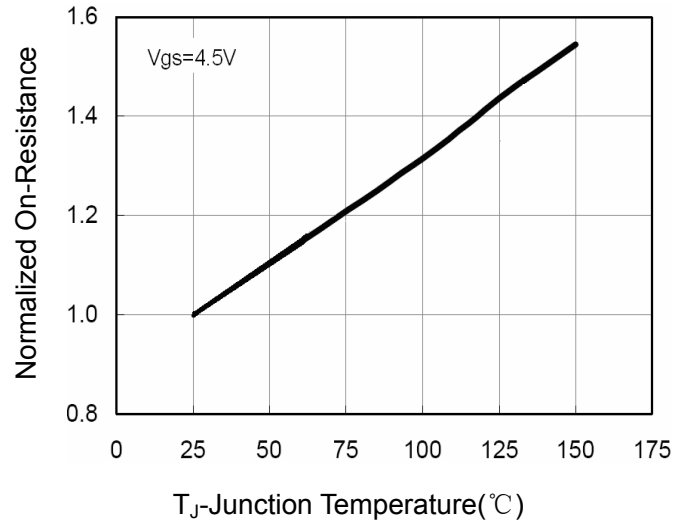

Figure 6 Drain-Source On-Resistance



Vgs Gate-Source Voltage (V)
Figure 7 Transfer Characteristics



T_J -Junction Temperature($^\circ\text{C}$)
Figure 8 Drain-Source On-Resistance

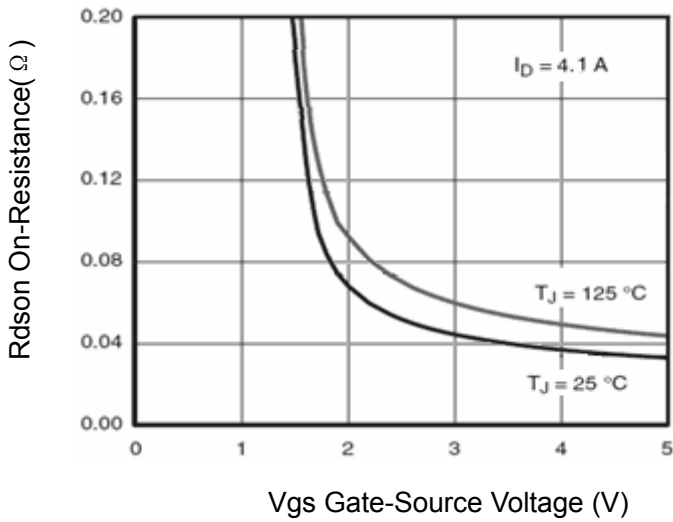

Vgs Gate-Source Voltage (V)
Figure 9 Rdson vs Vgs

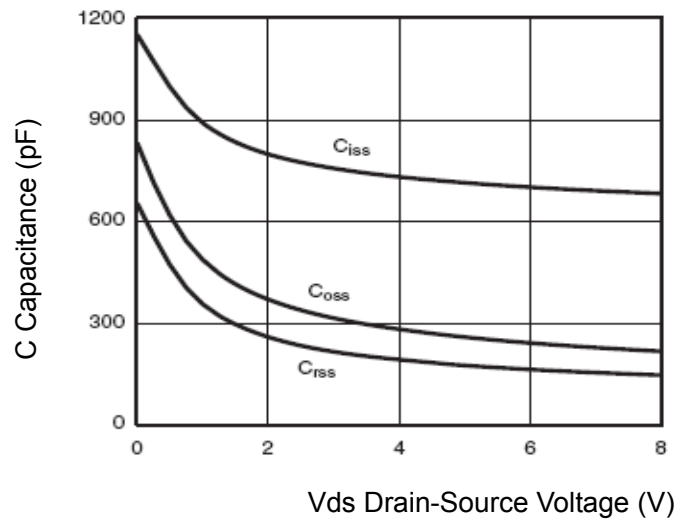

Vds Drain-Source Voltage (V)
Figure 10 Capacitance vs Vds

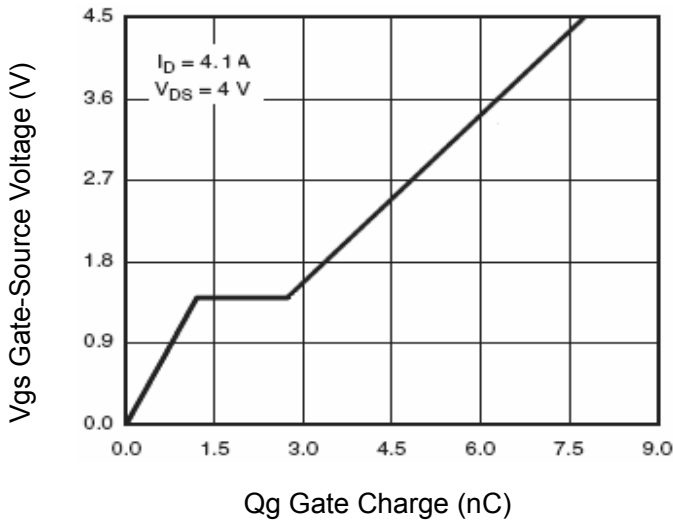

Qg Gate Charge (nC)
Figure 11 Gate Charge

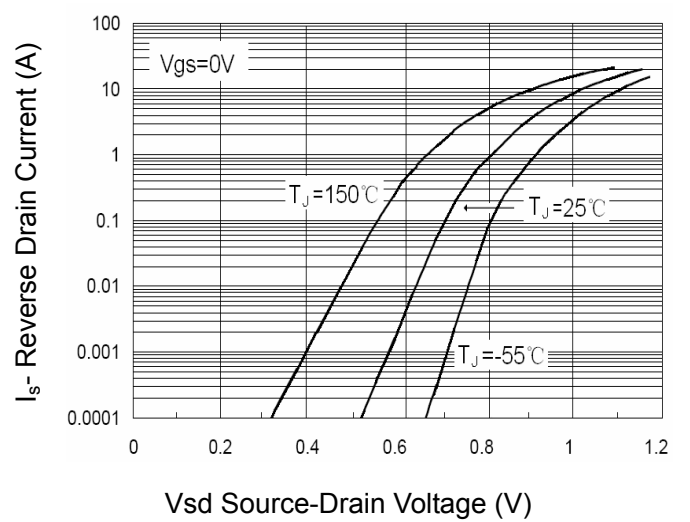

Vsd Source-Drain Voltage (V)
Figure 12 Source- Drain Diode Forward

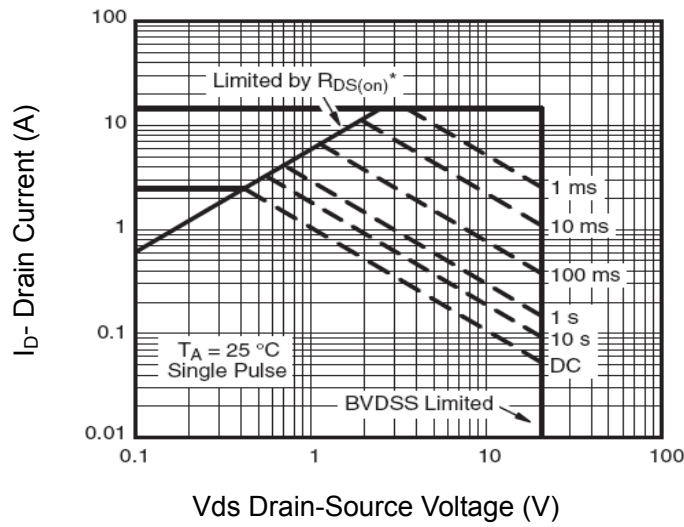

Figure 13 Safe Operation Area

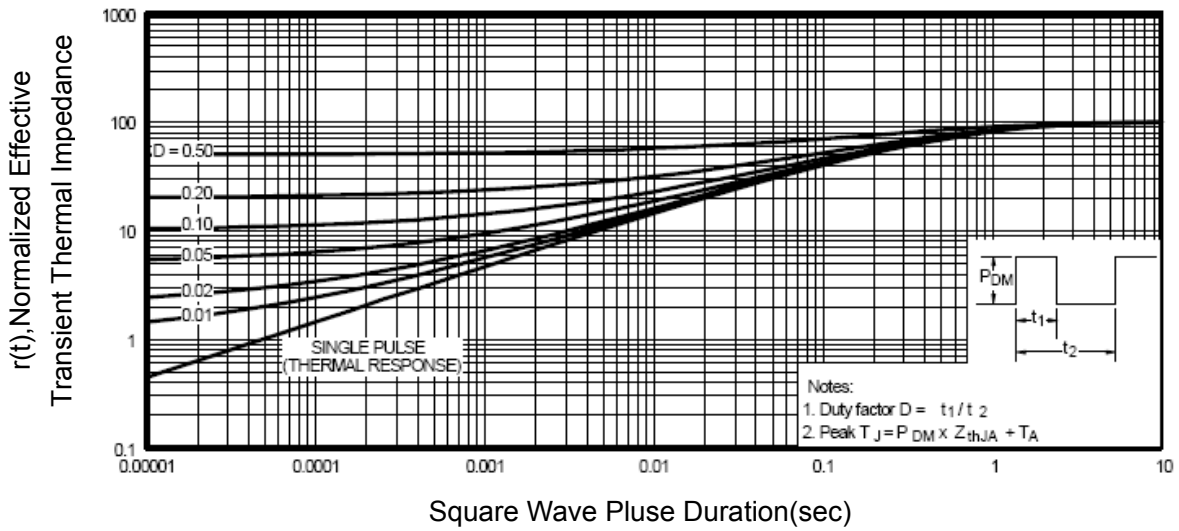

Figure 14 Normalized Maximum Transient Thermal Impedance

X-ON Electronics

Largest Supplier of Electrical and Electronic Components

Click to view similar products for [MOSFET](#) category:

Click to view products by [GOFORD](#) manufacturer:

Other Similar products are found below :

[614233C](#) [648584F](#) [MCH3443-TL-E](#) [MCH6422-TL-E](#) [FDPF9N50NZ](#) [FW216A-TL-2W](#) [FW231A-TL-E](#) [APT5010JVR](#) [NTNS3A92PZT5G](#)
[IRF100S201](#) [JANTX2N5237](#) [2SK2464-TL-E](#) [2SK3818-DL-E](#) [FCA20N60_F109](#) [FDZ595PZ](#) [STD6600NT4G](#) [FSS804-TL-E](#) [2SJ277-DL-E](#)
[2SK1691-DL-E](#) [2SK2545\(Q,T\)](#) [D2294UK](#) [405094E](#) [423220D](#) [MCH6646-TL-E](#) [TPCC8103,L1Q\(CM](#) [367-8430-0972-503](#) [VN1206L](#)
[424134F](#) [026935X](#) [051075F](#) [SBVS138LT1G](#) [614234A](#) [715780A](#) [NTNS3166NZT5G](#) [751625C](#) [873612G](#) [IRF7380TRHR](#)
[IPS70R2K0CEAKMA1](#) [RJK60S3DPP-E0#T2](#) [RJK60S5DPK-M0#T0](#) [APT5010JVFR](#) [APT12031JFLL](#) [APT12040JVR](#) [DMN3404LQ-7](#)
[NTE6400](#) [JANTX2N6796U](#) [JANTX2N6784U](#) [JANTXV2N5416U4](#) [SQM110N05-06L-GE3](#) [SIHF35N60E-GE3](#)