

## P-Channel Enhancement Mode Power MOSFET

### Description

The G700P06LL uses advanced trench technology to provide excellent  $R_{DS(ON)}$ , low gate charge. It can be used in a wide variety of applications.

### General Features

- $V_{DS}$  -60V
- $I_D$  (at  $V_{GS} = -10V$ ) -5A
- $R_{DS(ON)}$  (at  $V_{GS} = -10V$ ) < 75m $\Omega$
- $R_{DS(ON)}$  (at  $V_{GS} = -4.5V$ ) < 90m $\Omega$
- 100% Avalanche Tested
- RoHS Compliant

### Application

- Power switch
- DC/DC converters

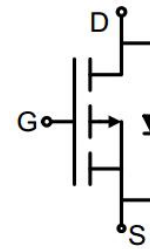

Schematic diagram

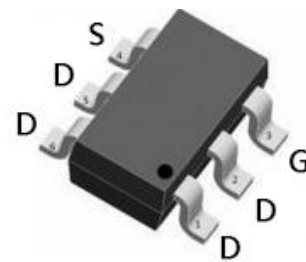

SOT-23-6L

### Ordering Information

Device	Package	Marking	Packaging
G700P06LL	SOT-23-6	G700P06	3000pcs/Reel

### Absolute Maximum Ratings $T_C = 25^\circ C$ , unless otherwise noted

Parameter	Symbol	Value	Unit
Drain-Source Voltage	$V_{DS}$	-60	V
Continuous Drain Current	$I_D$	-5	A
Pulsed Drain Current (note1)	$I_{DM}$	-20	A
Gate-Source Voltage	$V_{GS}$	$\pm 20$	V
Power Dissipation	$P_D$	3.1	W
Single pulse avalanche energy (note2)	$E_{AS}$	25	mJ
Operating Junction and Storage Temperature Range	$T_J, T_{stg}$	-55 To 150	$^\circ C$

### Thermal Resistance

Parameter	Symbol	Value	Unit
Thermal Resistance, Junction-to-Ambient	$R_{thJA}$	40.3	$^\circ C/W$

Specifications $T_J = 25^\circ\text{C}$ , unless otherwise noted						
Parameter	Symbol	Test Conditions	Value			Unit
			Min.	Typ.	Max.	
<b>Static Parameters</b>						
Drain-Source Breakdown Voltage	$V_{(BR)DSS}$	$V_{GS} = 0V, I_D = -250\mu A$	-60	--	--	V
Zero Gate Voltage Drain Current	$I_{DSS}$	$V_{DS} = -60V, V_{GS} = 0V$	--	--	-1	$\mu A$
Gate-Source Leakage	$I_{GSS}$	$V_{GS} = \pm 20V$	--	--	$\pm 100$	nA
Gate-Source Threshold Voltage	$V_{GS(th)}$	$V_{DS} = V_{GS}, I_D = -250\mu A$	-1.0	-1.8	-3.0	V
Drain-Source On-Resistance	$R_{DS(on)}$	$V_{GS} = -10V, I_D = -3.2A$	--	61	75	m $\Omega$
		$V_{GS} = -4.5V, I_D = -3.2A$	--	74	90	
Forward Transconductance	$g_{FS}$	$V_{DS} = -5V, I_D = -3.2A$	--	9	--	S
<b>Dynamic Parameters</b>						
Input Capacitance	$C_{iss}$	$V_{GS} = 0V,$ $V_{DS} = -30V,$ $f = 1.0MHz$	--	1456	--	pF
Output Capacitance	$C_{oss}$		--	71	--	
Reverse Transfer Capacitance	$C_{rss}$		--	64	--	
Total Gate Charge	$Q_g$	$V_{DD} = -30V,$ $I_D = -3A,$ $V_{GS} = -10V$	--	15.8	--	nC
Gate-Source Charge	$Q_{gs}$		--	2.7	--	
Gate-Drain Charge	$Q_{gd}$		--	3.5	--	
Turn-on Delay Time	$t_{d(on)}$	$V_{DD} = -30V,$ $I_D = -3A,$ $R_G = 3\Omega$	--	8	--	ns
Turn-on Rise Time	$t_r$		--	5	--	
Turn-off Delay Time	$t_{d(off)}$		--	32	--	
Turn-off Fall Time	$t_f$		--	8	--	
<b>Drain-Source Body Diode Characteristics</b>						
Continuous Body Diode Current	$I_S$	$T_C = 25^\circ\text{C}$	--	--	-5	A
Body Diode Voltage	$V_{SD}$	$T_J = 25^\circ\text{C}, I_{SD} = -30A, V_{GS} = 0V$	--	--	-1.2	V
Reverse Recovery Charge	$Q_{rr}$	$I_F = -3A, V_{GS} = 0V$ $di/dt = -100A/\mu s$	--	32	--	nC
Reverse Recovery Time	$T_{rr}$		--	27	--	ns

### Notes

1. Repetitive Rating: Pulse width limited by maximum junction temperature
2. EAS condition :  $T_J = 25^\circ\text{C}, V_{DD} = -50V, V_{GS} = -10V, L = 0.5mH, R_G = 25\Omega$
3. Identical low side and high side switch with identical  $R_G$

### Gate Charge Test Circuit

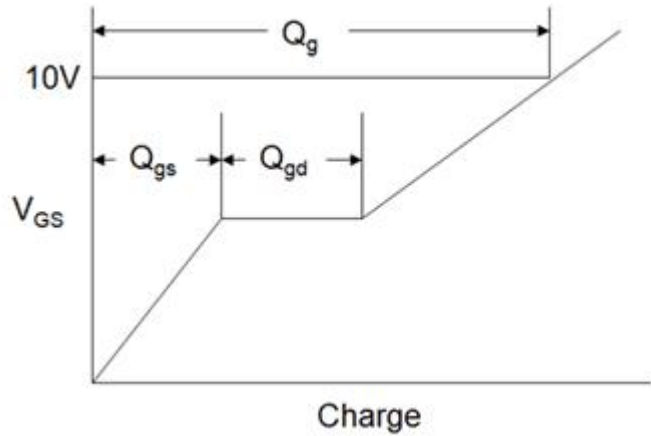

### Switch Time Test Circuit

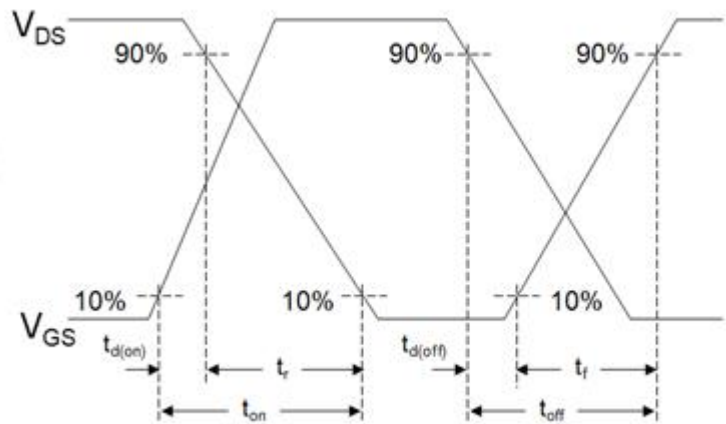
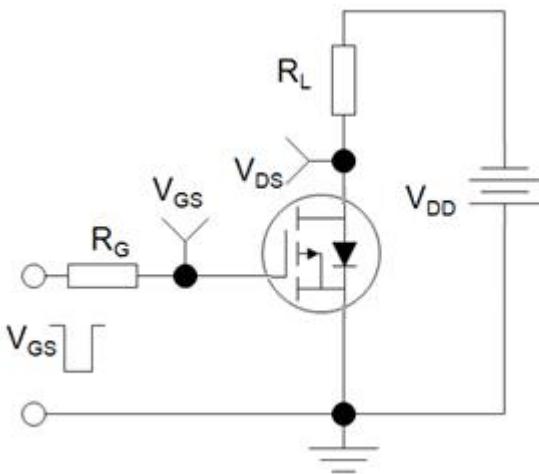

### EAS Test Circuit

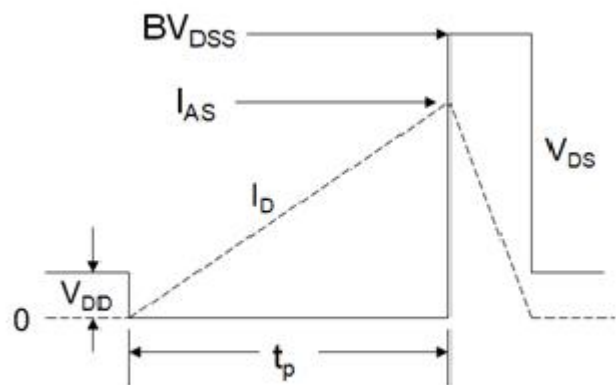

Typical Characteristics  $T_J = 25^\circ\text{C}$ , unless otherwise noted

Figure 1. Output Characteristics

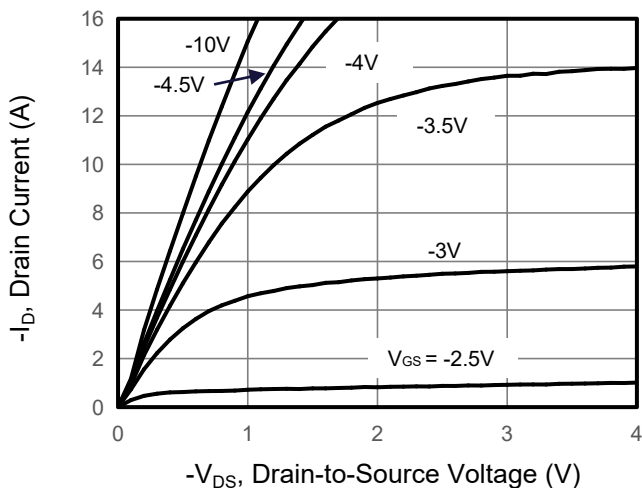

Figure 2. Transfer Characteristics

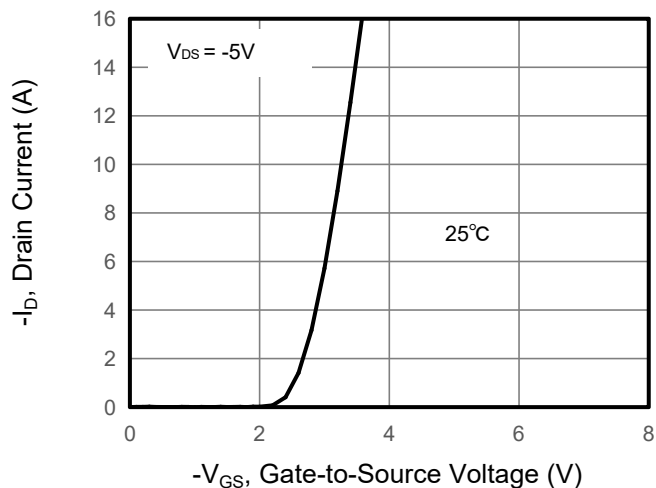

Figure 3. Drain Source On Resistance

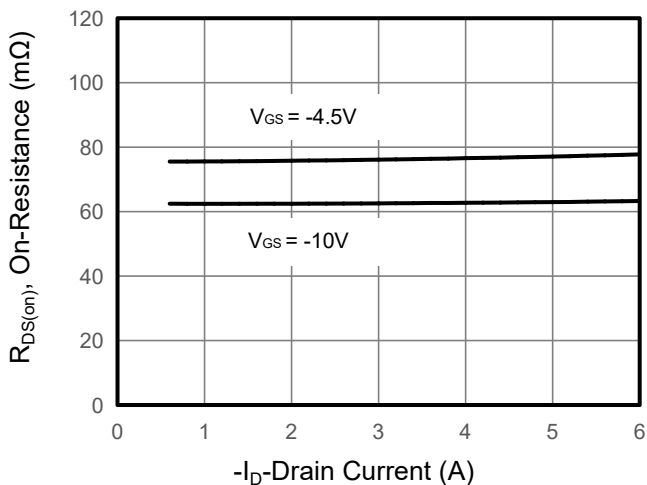

Figure 4. Gate Charge

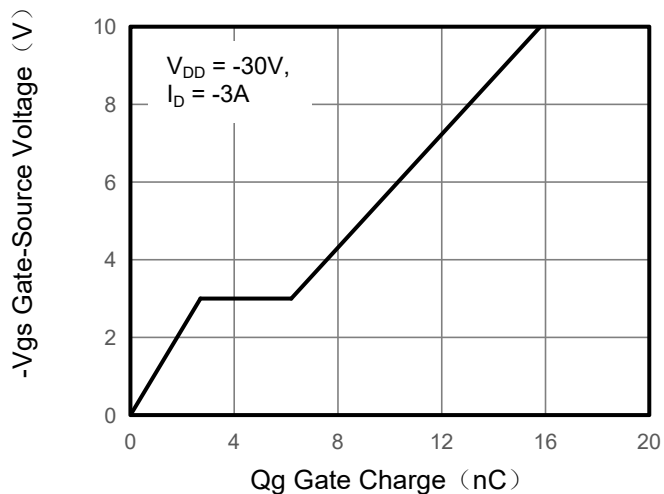

Figure 5. Capacitance

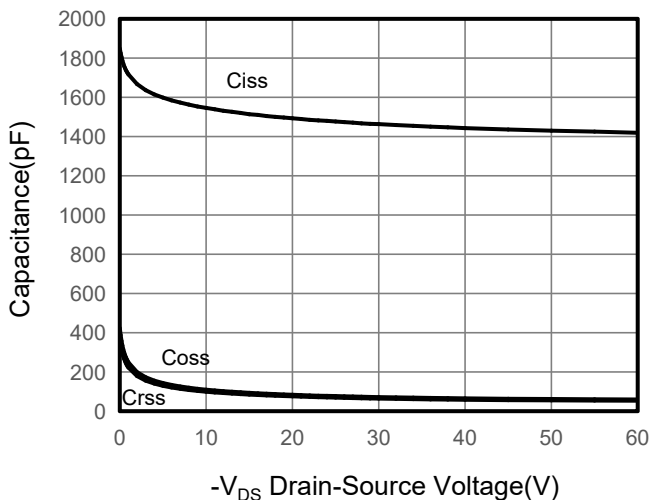
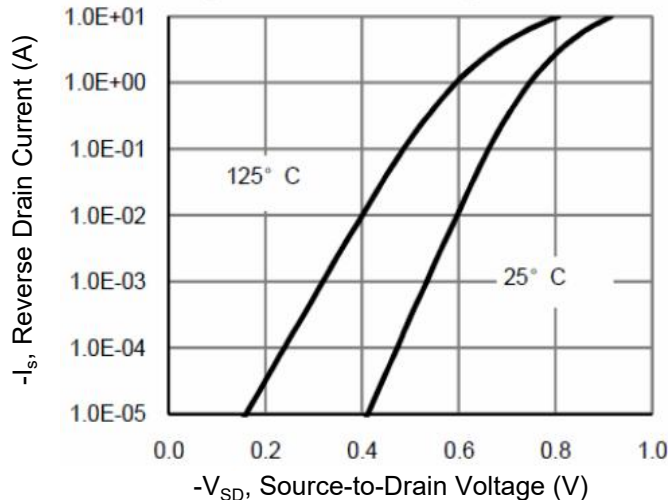

Figure 6. Source-Drain Diode Forward



Typical Characteristics  $T_J = 25^\circ\text{C}$ , unless otherwise noted

Figure 7. Drain-Source On-Resistance

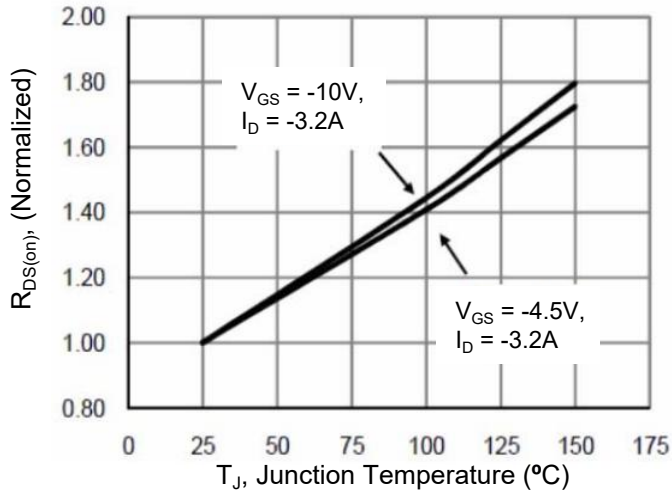

Figure 10. Safe Operation Area

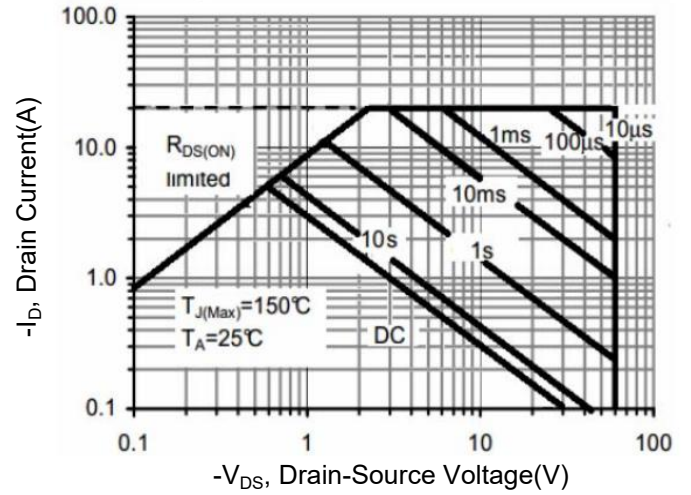
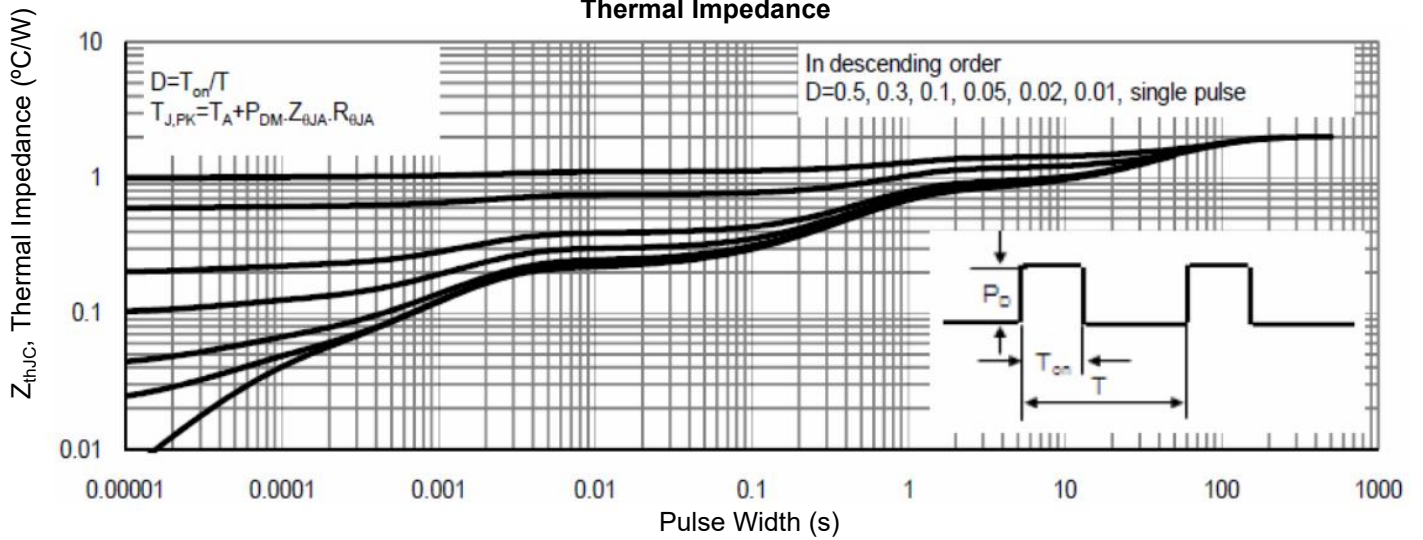
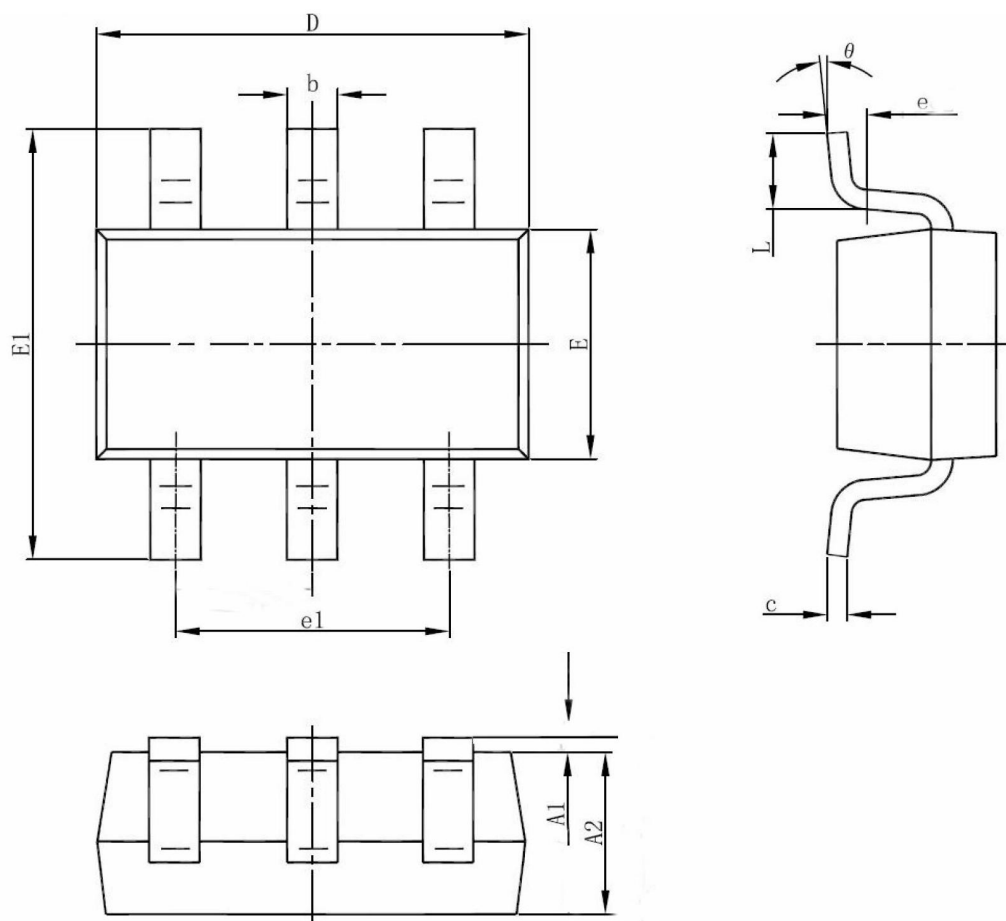

Figure 9. Normalized Maximum Transient Thermal Impedance



## SOT-23-6L Package Information



DIM	MIN	NOM	MAX
A1	0.00	-	0.10
A2	1.00	1.10	1.20
b	0.30	0.40	0.50
c	0.10	0.15	0.20
D	2.80	2.90	3.00
E	1.50	1.60	1.70
E1	2.60	2.80	3.00
e	0.2GAUGE PLANE		
e1	-	1.90	-
L	0.30	0.45	0.60
$\theta$	0°	-	8°
All Dimensions in mm			

## X-ON Electronics

Largest Supplier of Electrical and Electronic Components

*Click to view similar products for [MOSFET](#) category:*

*Click to view products by [GOFORD](#) manufacturer:*

Other Similar products are found below :

[IRFD120](#) [JANTX2N5237](#) [BUK455-60A/B](#) [MIC4420CM-TR](#) [VN1206L](#) [NDP4060](#) [SI4482DY](#) [IPS70R2K0CEAKMA1](#) [SQD23N06-31L-GE3](#)  
[TK16J60W,S1VQ\(O](#) [2SK2614\(TE16L1,Q\)](#) [DMN1017UCP3-7](#) [DMN1053UCP4-7](#) [SQJ469EP-T1-GE3](#) [NTE2384](#) [DMC2700UDMQ-7](#)  
[DMN2080UCB4-7](#) [DMN61D9UWQ-13](#) [US6M2GTR](#) [DMN31D5UDJ-7](#) [DMP22D4UFO-7B](#) [DMN1006UCA6-7](#) [DMN16M9UCA6-7](#)  
[STF5N65M6](#) [IRF40H233XTMA1](#) [STU5N65M6](#) [DMN6022SSD-13](#) [DMN13M9UCA6-7](#) [DMTH10H4M6SPS-13](#) [DMN2990UFB-7B](#)  
[IPB80P04P405ATMA2](#) [2N7002W-G](#) [MCAC30N06Y-TP](#) [MCQ7328-TP](#) [NTMC083NP10M5L](#) [BXP7N65D](#) [BXP4N65F](#) [AOL1454G](#)  
[WMJ80N60C4](#) [BXP2N20L](#) [BXP2N65D](#) [BXT1150N10J](#) [BXT1700P06M](#) [TSM60NB380CP](#) [ROG](#) [RQ7L055BGTGR](#) [DMNH15H110SK3-13](#)  
[SLF10N65ABV2](#) [BSO203SP](#) [BSO211P](#) [IPA60R230P6](#)