

800V N-Channel MOSFET

FEATURES

V _{DSS}	R _{DSON} @ 10V (Typ)	I _D
800V	1.35Ω	7 A

- Fast switching
- 100% avalanche tested
- Improved dv/dt capability
- RoHS Compliant

APPLICATIONS

- Switch Mode Power Supply (SMPS)
- Uninterruptible Power Supply (UPS)
- Power Factor Correction (PFC)

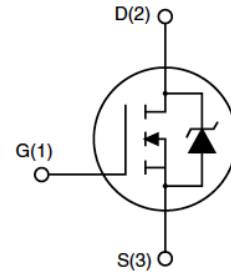

Schematic diagram

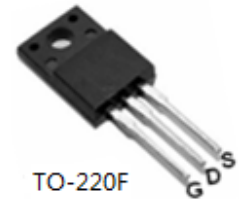

Ordering Information

Part Number	Marking	Case	Packaging
G7N80T	G7N80	TO-220	50pcs/Tube
G7N80CF	G7N80	TO-220F	50pcs/Tube

Absolute Maximum Ratings $T_C = 25^\circ\text{C}$, unless otherwise noted

Parameter	Symbol	Value		Unit
		TO-220F	TO-220	
Drain-Source Voltage ($V_{GS} = 0V$)	V_{DSS}	800		V
Continuous Drain Current	I_D	7		A
Pulsed Drain Current (note1)	I_{DM}	28		A
Gate-Source Voltage	V_{GSS}	± 30		V
Single Pulse Avalanche Energy (note2)	E_{AS}	245		mJ
Avalanche Current (note1)	I_{AS}	7		A
Repetitive Avalanche Energy (note1)	E_{AR}	147		mJ
Power Dissipation ($T_C = 25^\circ\text{C}$)	P_D	25	70	W
Operating Junction and Storage Temperature Range	T_J, T_{stg}	-55~+150		$^\circ\text{C}$

Thermal Resistance

Parameter	Symbol	Value		Unit
		TO-220F	TO-220	
Thermal Resistance, Junction-to-Case	R_{thJC}	5	1.78	K/W
Thermal Resistance, Junction-to-Ambient	R_{thJA}	62.5	60	

Specifications $T_J = 25^\circ\text{C}$, unless otherwise noted						
Parameter	Symbol	Test Conditions	Value			Unit
			Min.	Typ.	Max.	
Static						
Drain-Source Breakdown Voltage	$V_{(BR)DSS}$	$V_{GS} = 0V, I_D = 250\mu A$	800	--	--	V
Zero Gate Voltage Drain Current	I_{DSS}	$V_{DS} = 800V, V_{GS} = 0V, T_J = 25^\circ\text{C}$	--	--	1	μA
		$V_{DS} = 640V, V_{GS} = 0V, T_J = 125^\circ\text{C}$	--	--	100	
Gate-Source Leakage	I_{GSS}	$V_{GS} = \pm 30V$	--	--	± 100	nA
Gate-Source Threshold Voltage	$V_{GS(th)}$	$V_{DS} = V_{GS}, I_D = 250\mu A$	3.0	--	4.0	V
Drain-Source On-Resistance (Note3)	$R_{DS(on)}$	$V_{GS} = 10V, I_D = 3.5A$	--	1.35	1.6	Ω
Dynamic						
Input Capacitance	C_{iss}	$V_{GS} = 0V,$ $V_{DS} = 25V,$ $f = 1.0\text{MHz}$	--	1178	--	μF
Output Capacitance	C_{oss}		--	128	--	
Reverse Transfer Capacitance	C_{rss}		--	27	--	
Total Gate Charge	Q_g	$V_{DD} = 640V, I_D = 7A,$ $V_{GS} = 10V$	--	49	--	nC
Gate-Source Charge	Q_{gs}		--	6	--	
Gate-Drain Charge	Q_{gd}		--	26	--	
Turn-on Delay Time	$t_{d(on)}$	$V_{DD} = 400V, I_D = 7A,$ $R_G = 25\Omega$	--	43	--	ns
Turn-on Rise Time	t_r		--	28	--	
Turn-off Delay Time	$t_{d(off)}$		--	244	--	
Turn-off Fall Time	t_f		--	54	--	
Drain-Source Body Diode Characteristics						
Continuous Body Diode Current	I_S	$T_C = 25^\circ\text{C}$	--	--	7	A
Pulsed Diode Forward Current	I_{SM}		--	--	28	
Body Diode Voltage	V_{SD}	$T_J = 25^\circ\text{C}, I_{SD} = 3.5A, V_{GS} = 0V$	--	--	1.4	V
Reverse Recovery Time	t_{rr}	$V_{GS} = 0V, I_S = 7A,$ $di_F/dt = 100A/\mu s$	--	295	--	ns
Reverse Recovery Charge	Q_{rr}		--	1.7	--	μC

Notes

1. Repetitive Rating: Pulse width limited by maximum junction temperature
2. $L=10\text{mH}, V_{DD} = 50V, R_G = 25\Omega$, Starting $T_J = 25^\circ\text{C}$
3. Pulse Test: Pulse width $\leq 300\mu s$, Duty Cycle $\leq 1\%$

Typical Characteristics $T_J = 25^\circ\text{C}$, unless otherwise noted

Figure 1. Output Characteristics ($T_J = 25^\circ\text{C}$)

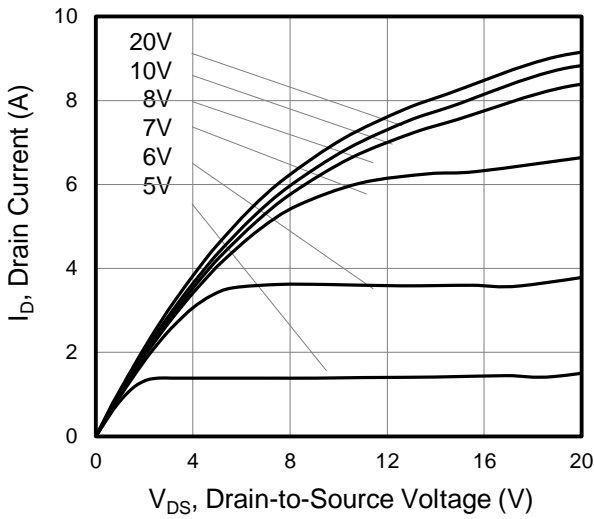

Figure 2. Body Diode Forward Voltage

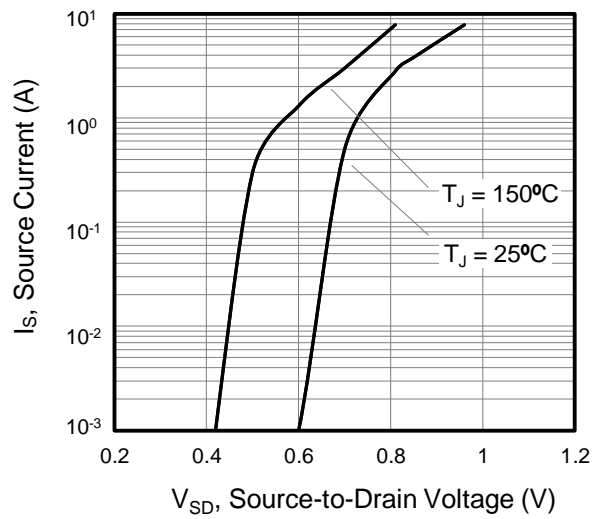

Figure 3. Drain Current vs. Temperature

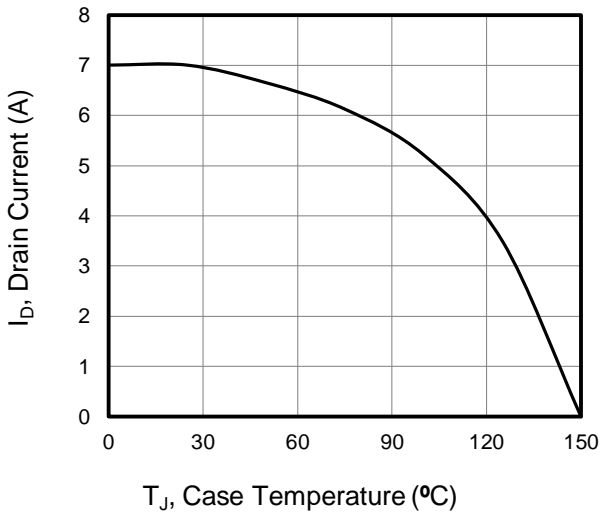

Figure 4. BV_{DSS} Variation vs. Temperature

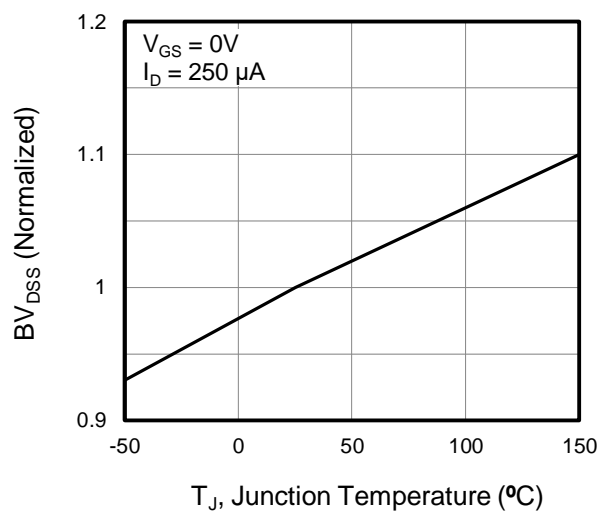

Figure 5. Transfer Characteristics

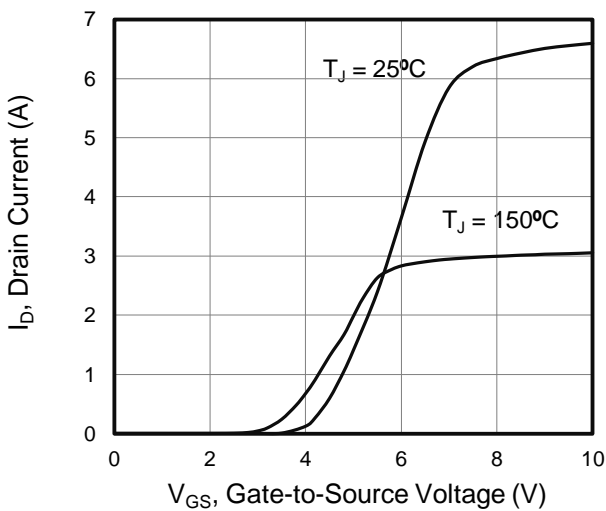
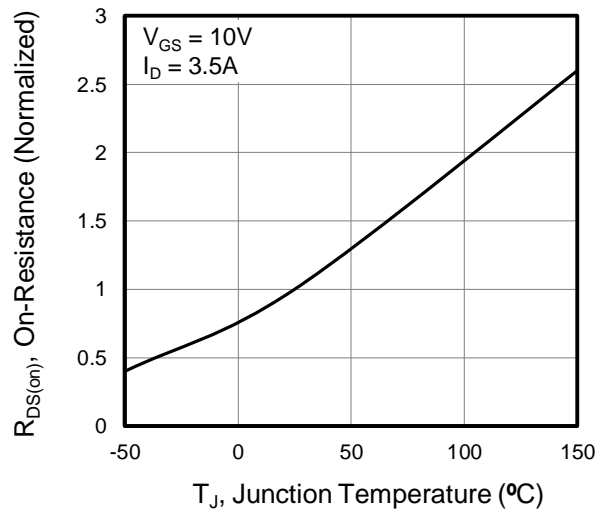

Figure 6. On-Resistance vs. Temperature



Typical Characteristics $T_J = 25^\circ\text{C}$, unless otherwise noted

Figure 7. Capacitance

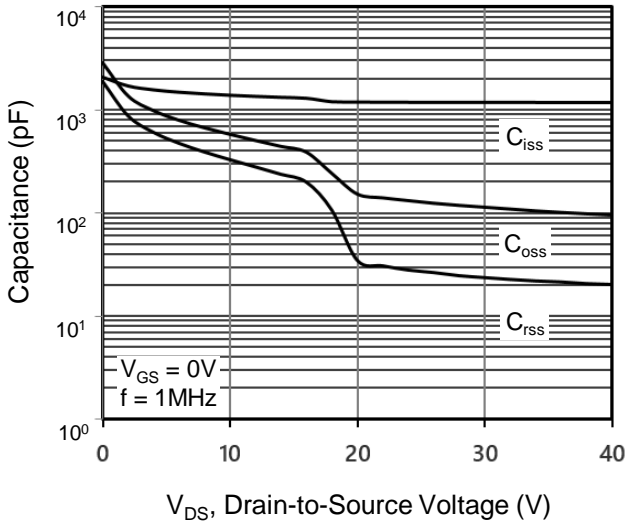

Figure 8. Gate Charge

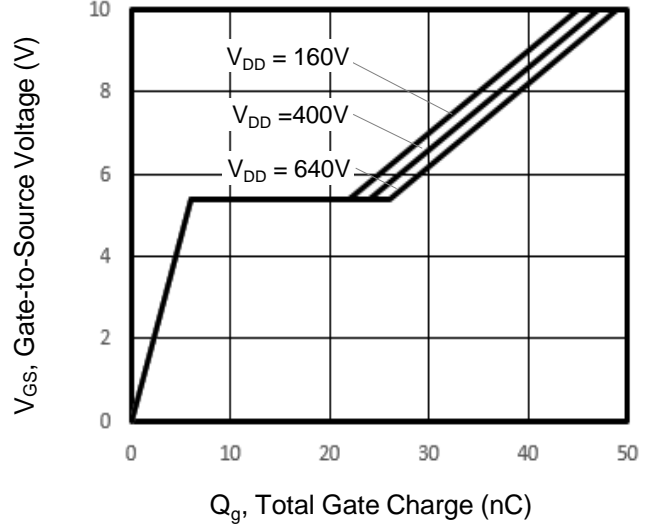

Figure 9. Transient Thermal Impedance TO-220F

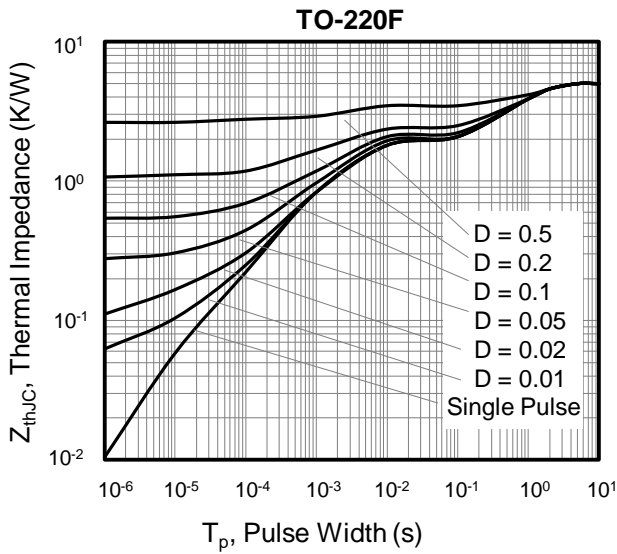

Figure 10. Transient Thermal Impedance TO-220

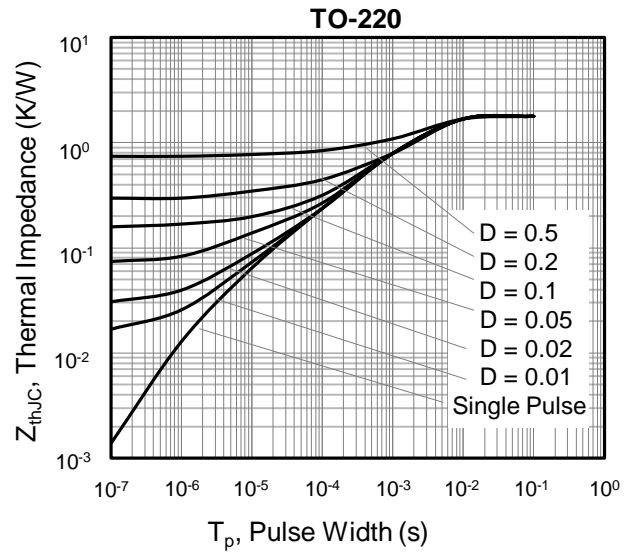

Figure A: Gate Charge Test Circuit and Waveform

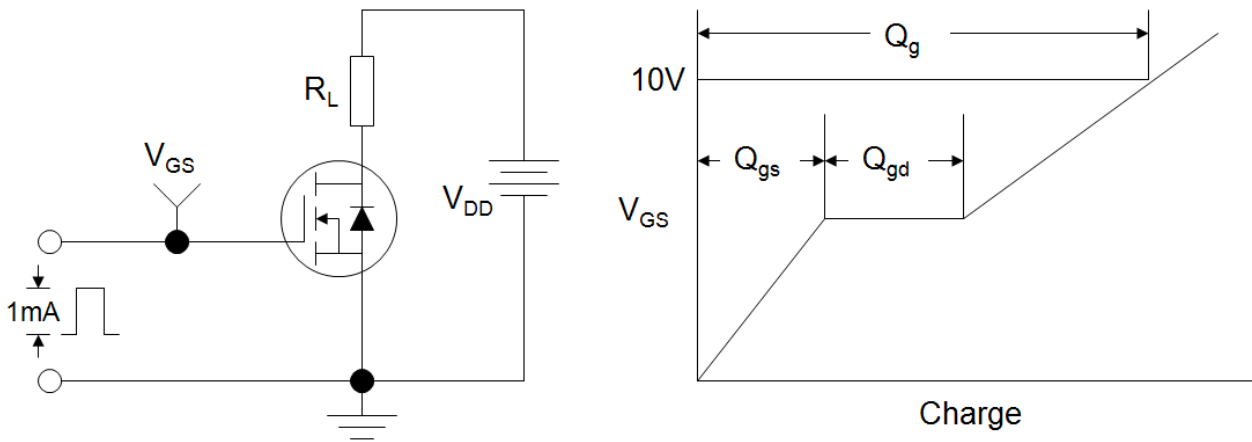

Figure B: Resistive Switching Test Circuit and Waveform

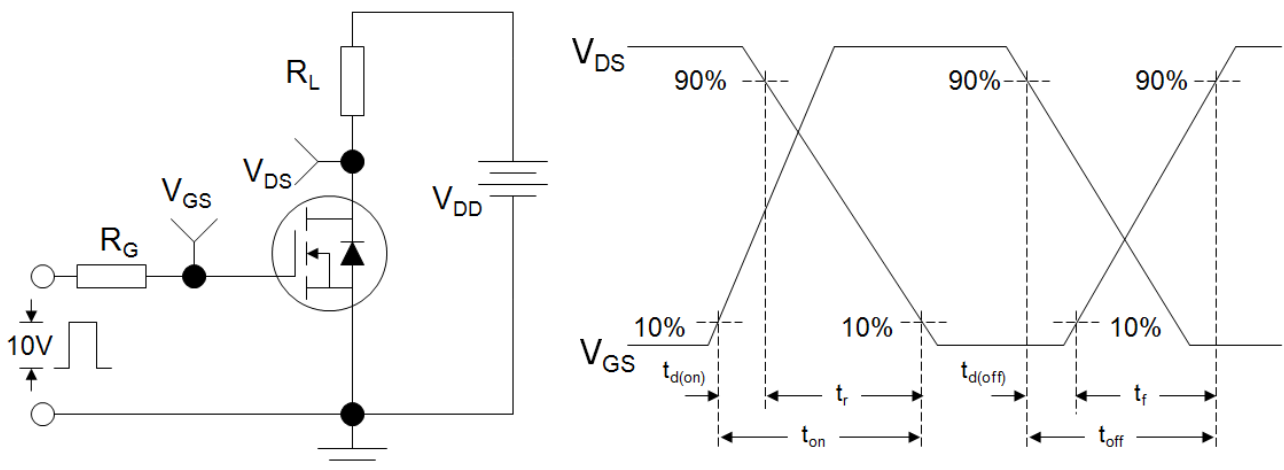
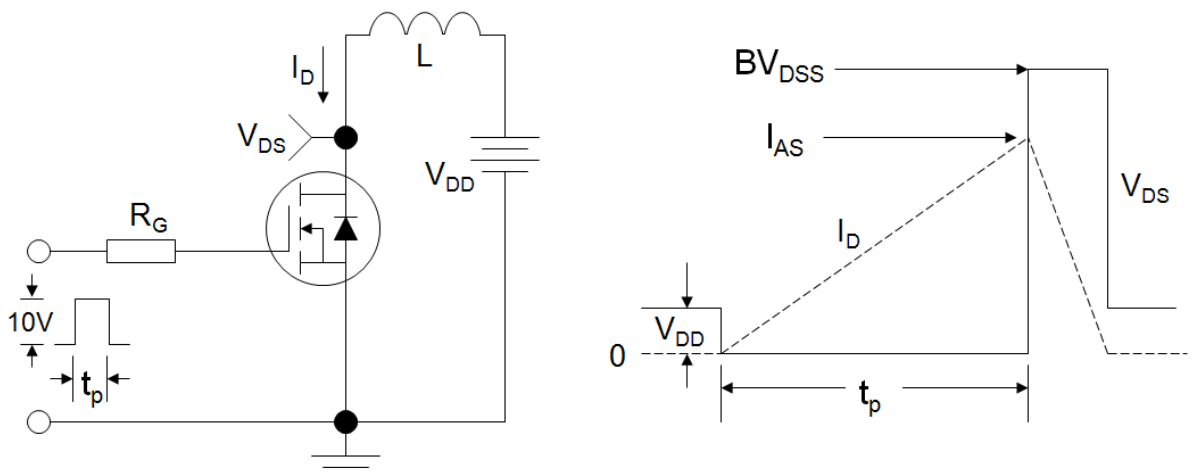
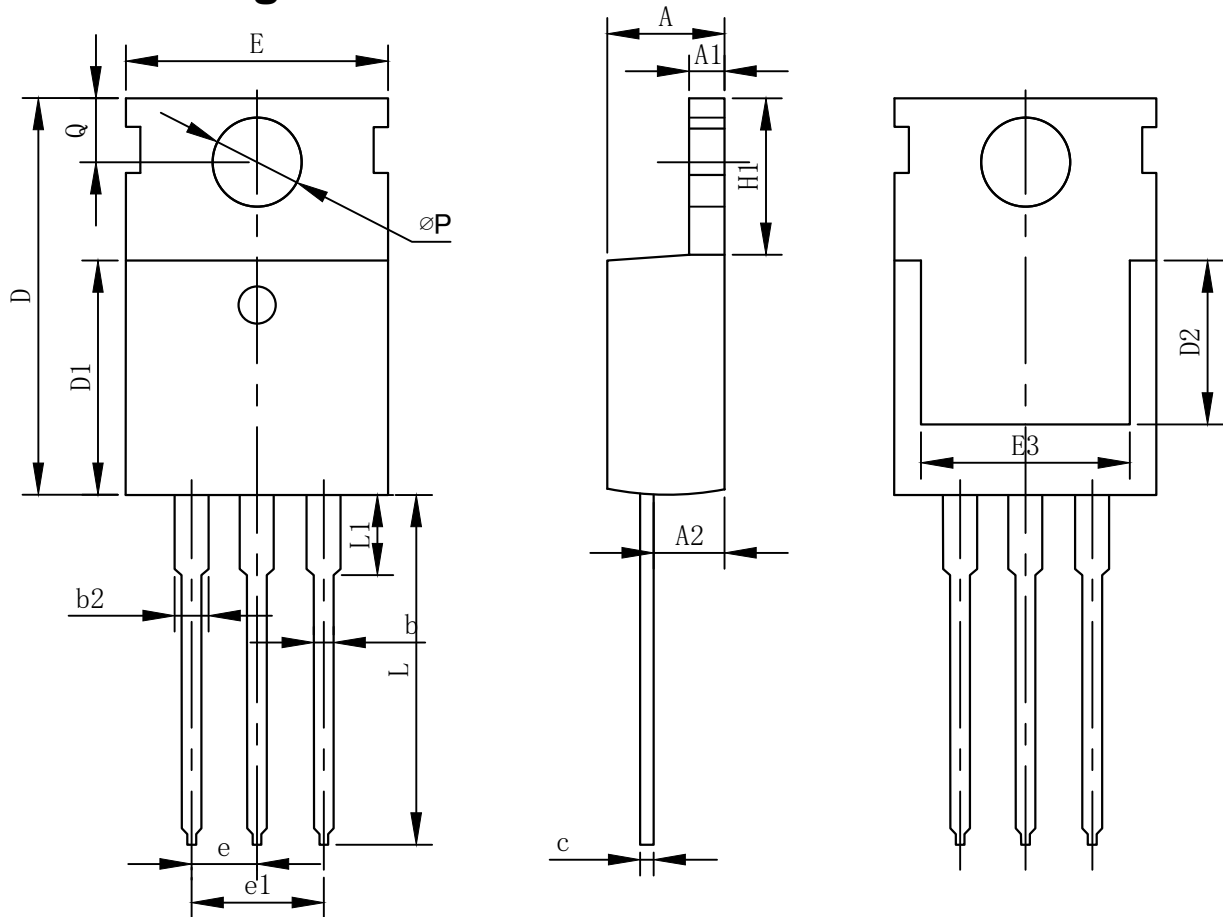

Figure C: Unclamped Inductive Switching Test Circuit and Waveform



TO-220 Package information



COMMON DIMENSIONS

SYMBOL	mm		
	MIN	NOM	MAX
A	4.37	4.57	4.70
A1	1.25	1.30	1.40
A2	2.20	2.40	2.60
b	0.70	0.80	0.95
b2	1.70	1.27	1.47
c	0.45	0.50	0.60
D	15.10	15.60	16.10
D1	8.80	9.10	9.40
D2	5.50	-	-
E	9.70	10.00	10.30
E3	7.00	-	-
e	2.54BSC		
e1	5.08BSC		
H1	6.25	6.50	6.85
L	12.75	13.50	13.80
L1	-	3.10	3.40
øP	3.40	3.60	3.80
Q	2.60	2.80	3.00

TO-220F Package information

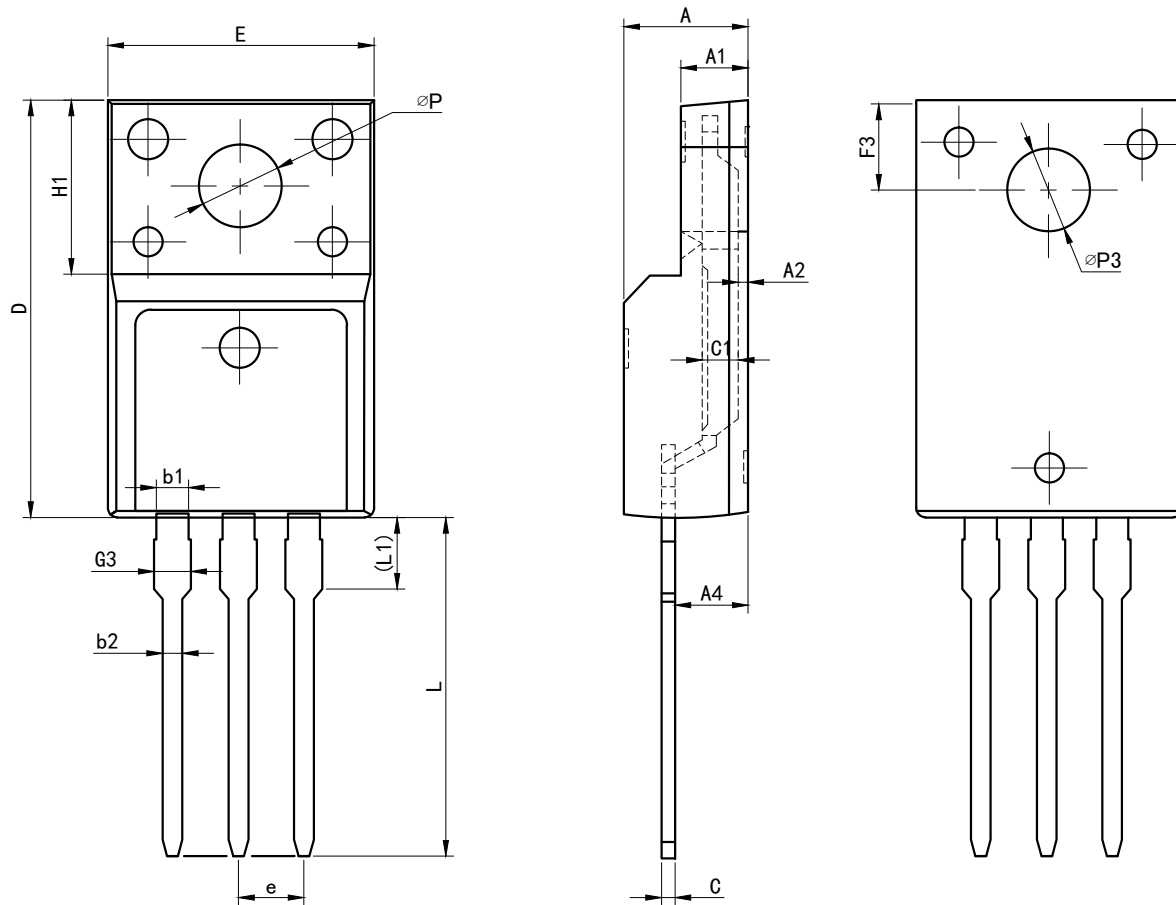

COMMON DIMENSIONS

SYMBOL	mm		
	MIN	NOM	MAX
E	9.96	10.16	10.36
A	4.50	4.70	4.90
A1	2.34	2.54	2.74
A2	0.30	0.45	0.60
A4	2.56	2.76	2.96
c	0.40	0.50	0.65
c1	1.20	1.30	1.35
D	15.57	15.87	16.17
H1	6.70REF		
e	2.54BSC		
L	12.68	12.98	13.28
L1	2.93	3.03	3.13
ϕP	3.03	3.18	3.38
$\phi P3$	3.15	3.45	3.65
F3	3.15	3.30	3.45
G3	1.25	1.35	1.55
b1	1.18	1.28	1.43
b2	0.70	0.80	0.95

X-ON Electronics

Largest Supplier of Electrical and Electronic Components

Click to view similar products for [MOSFET](#) category:

Click to view products by [GOFORD](#) manufacturer:

Other Similar products are found below :

[IRFD120](#) [JANTX2N5237](#) [BUK455-60A/B](#) [MIC4420CM-TR](#) [VN1206L](#) [NDP4060](#) [SI4482DY](#) [IPS70R2K0CEAKMA1](#) [SQD23N06-31L-GE3](#)
[TK16J60W,S1VQ\(O](#) [2SK2614\(TE16L1,Q\)](#) [DMN1017UCP3-7](#) [DMN1053UCP4-7](#) [SQJ469EP-T1-GE3](#) [NTE2384](#) [DMC2700UDMQ-7](#)
[DMN2080UCB4-7](#) [DMN61D9UWQ-13](#) [US6M2GTR](#) [DMN31D5UDJ-7](#) [DMP22D4UFO-7B](#) [DMN1006UCA6-7](#) [DMN16M9UCA6-7](#)
[STF5N65M6](#) [IRF40H233XTMA1](#) [STU5N65M6](#) [DMN6022SSD-13](#) [DMN13M9UCA6-7](#) [DMTH10H4M6SPS-13](#) [DMN2990UFB-7B](#)
[IPB80P04P405ATMA2](#) [2N7002W-G](#) [MCAC30N06Y-TP](#) [MCQ7328-TP](#) [NTMC083NP10M5L](#) [NVMFS2D3P04M8LT1G](#) [BXP7N65D](#)
[BXP4N65F](#) [AOL1454G](#) [WMJ80N60C4](#) [BXP2N20L](#) [BXP2N65D](#) [BXT1150N10J](#) [BXT1700P06M](#) [TSM60NB380CP](#) [ROG](#) [RQ7L055BGTCR](#)
[DMNH15H110SK3-13](#) [SLF10N65ABV2](#) [BSO203SP](#) [BSO211P](#)